



ANCHORAGE STORMWATER MANUAL

Volume 1

Management and Design Criteria

(Design Criteria Manual Chapter 2 – Drainage)

Version 1.0

December 2017

Intentionally Left Blank

TABLE OF CONTENTS

1.0	INTRODUCTION	1-1
1.1	Objective of This Manual	1-1
1.2	Related Guidance	1-1
1.3	How To Use This Manual	1-1
1.4	Regulatory Requirements for Pollution Prevention.....	1-2
1.4.1	EPA National Pollutant Discharge Elimination System (NPDES) Permit Program.....	1-3
1.4.2	Non-Applicability.....	1-3
1.4.3	Local and State Codes Related to Stormwater	1-4
1.5	Municipal Stormwater Policies	1-4
1.6	Drainage Design Variances.....	1-5
2.0	OVERVIEW OF STORMWATER MANAGEMENT	2-1
2.1	The Need for Stormwater Management	2-1
2.1.1	Impacts of Development and Stormwater Runoff.....	2-1
2.1.2	Development Changes Land and Runoff.....	2-1
2.1.3	Changes to Stream Flow	2-2
2.1.4	Changes to Stream Geometry.....	2-3
2.1.5	Impacts to Aquatic Habitat	2-5
2.1.6	Water Quality Impacts	2-5
2.1.7	Stormwater Hotspots.....	2-8
2.1.8	Effects on Lakes, Reservoirs and Estuaries	2-9
2.2	Addressing Stormwater Impacts.....	2-9
3.0	STORMWATER MANAGEMENT REQUIREMENTS	3-1
3.1	Overview	3-1
3.2	Stormwater Plan Review and Approval	3-1
3.3	Stormwater Management Requirements.....	3-1
3.3.1	Project Classifications	3-1
3.3.2	Stormwater Management Requirements.....	3-2
3.4	Reporting Requirements.....	3-11

3.4.1	Drainage Project Notification.....	3-11
3.4.2	Stormwater Management Report Components.....	3-12
4.0	ESTIMATING STORMWATER RUNOFF	4-1
4.1	Introduction to Hydrologic Methods	4-1
4.2	Design Storms and Rainfall Estimation	4-1
4.2.1	Intensity-Duration-Frequency Curves.....	4-1
4.2.2	Design Storm Depth – Base and Adjusted	4-3
4.2.3	Storm Duration	4-5
4.2.4	Storm Distribution.....	4-5
4.3	Runoff Response	4-8
4.4	Precipitation Losses	4-8
4.4.1	Precipitation Loss Methods.....	4-9
4.4.2	NRCS (SCS) Soil Classifications	4-14
4.5	Transforming Excess Rainfall Into Runoff Quantities.....	4-15
4.5.1	Direct Determination Method	4-17
4.5.2	Rational Method	4-19
4.5.3	NRCS (SCS) Peak Flow Method (Tabular Method)	4-20
4.5.4	USGS Regression Equations	4-20
4.5.5	NRCS (SCS) Tabular Hydrograph Method.....	4-21
4.5.6	Unit Hydrographs.....	4-22
4.5.7	Kinematic-Wave Method	4-23
4.5.8	Non-Linear Reservoir Method	4-23
4.6	Time of Concentration	4-23
4.7	Routing Stormwater Runoff.....	4-28
4.7.1	Steady Flow Routing	4-28
4.7.2	Kinematic Wave Routing.....	4-28
4.7.3	Dynamic Wave Routing.....	4-28
4.8	Computer Models	4-29
5.0	CONVENTIONAL STORMWATER FACILITIES	5-1
5.1	Introduction	5-1
5.2	Storm Events for Conveyance Design	5-1

5.3	Piped Storm Drain Systems.....	5-1
5.3.1	Objectives.....	5-1
5.3.2	Pipe Sizing and Standards	5-1
5.3.3	Freeze Protection Criteria	5-4
5.3.4	Thaw Systems Criteria.....	5-4
5.3.5	Manhole Criteria	5-5
5.3.6	Culvert Criteria	5-6
5.3.7	Subdrain Criteria	5-9
5.3.8	Cleanout Criteria	5-10
5.3.9	Outfall Criteria.....	5-10
5.3.10	Lift Station Criteria	5-11
5.4	Drainage Criteria for Streets	5-16
5.4.1	Curbs and Gutters	5-16
5.4.2	Ditches	5-16
5.4.3	Storm Drain Inlets	5-16
5.4.4	Valley Gutters.....	5-17
5.4.5	Pavement Encroachment.....	5-17
5.4.6	Subsurface Drainage Control	5-17
5.5	Open Channels.....	5-17
5.5.1	General.....	5-17
5.5.2	Design Methods	5-17
5.5.3	Side Slopes	5-18
5.5.4	Flow Velocity.....	5-18
5.6	Channel Erosion Control Design.....	5-18
5.7	Stream Restoration	5-19
5.8	Icing Control Design	5-21
6.0	STRUCTURAL STORMWATER CONTROLS.....	6-1
6.1	Introduction to Structural Stormwater Controls	6-1
6.2	Site Evaluation Considerations	6-1
6.3	Cold Weather Considerations	6-5
6.4	Selecting Appropriate Stormwater Controls.....	6-7

6.5	Stormwater Pond Safety Consideration	6-10
6.6	Design Criteria for Structural Stormwater Controls.....	6-13
6.6.1	Bioretention Facilities	6-14
6.6.2	Soakaway Pits.....	6-24
6.6.3	Infiltration Basins	6-30
6.6.4	Infiltration Trenches.....	6-39
6.6.5	Vegetated Swales.....	6-49
6.6.6	Pervious Pavement	6-54
6.6.7	Chamber Systems.....	6-61
6.6.8	Wet Ponds.....	6-68
6.6.9	Dry Ponds	6-77
6.6.10	Oversized Pipes	6-84
6.6.11	Filter Strips	6-89
6.6.12	Constructed Wetlands	6-98
6.6.13	Landscaped Depressions.....	6-113
6.6.14	Canopy Cover and Natural Vegetation Retention	6-118
6.6.15	Catch Basins for Sediment Capture Treatment	6-123
6.6.16	Sedimentation Basins.....	6-126
6.6.17	Oil and Grit Separators.....	6-139
6.7	Gravel Check Dam	6-143
6.8	Outlet Protection and Riprap.....	6-145
6.8.1	Riprap Apron	6-145
6.8.2	Riprap Aprons after Energy Dissipaters	6-147
6.8.3	Other Riprap Applications.....	6-148
6.8.4	Implementation	6-148
6.8.5	Maintenance	6-148
7.0	BETTER SITE DESIGN PRACTICES	7-1
7.1	Introduction to Better Site Design Practices.....	7-1
7.2	Descriptions of Specific Better Site Design Practices.....	7-1
7.2.1	Create Parking Lot Stormwater “Islands”	7-1
7.2.2	Use Buffers and Undisturbed Areas.....	7-2

7.2.3	Use Vegetated Swales Instead of Curb and Gutter.....	7-2
7.2.4	Drain Runoff to Pervious Areas.....	7-2
7.2.5	Think Small.....	7-3
7.3	Recommended Resources.....	7-3
8.0	SNOW STORAGE REQUIREMENTS.....	8-1
8.1	Snow Melt Guidelines.....	8-1
8.2	Snow Storage and Snow Disposal Site Design Criteria.....	8-1
8.2.1	Introduction.....	8-1
8.2.2	Site Selection Criteria.....	8-2
8.2.3	Design Information.....	8-4
8.2.4	Specific Design Criteria.....	8-4
8.2.5	General Design Criteria.....	8-7
8.2.6	Snow Disposal Operational Practices.....	8-8
9.0	REFERENCES.....	9-1

APPENDIX

Appendix A – Drainage Certification and WMS Mapping Forms

Appendix B – Sample Operations and Maintenance Agreement and Annual Reporting Form

Appendix C – Anchorage Drainage Studies Inventory

Appendix D – MOA Rainfall and Snowmelt Hyetographs

Appendix E – Plant List

Appendix F – Class V Injection Well Memorandum

Appendix G – Infiltration Testing Methods and Frequency

Appendix H – Additional Guidance for Bioretention Soils

Appendix I – Private Snow Disposal Sites White Paper

Appendix J – Snow Disposal Site Seeding Specifications

Appendix K – Daily Pollutant Build-Up Ranges

Appendix L – Green Infrastructure Feasibility Forms

LIST OF TABLES

Table 2.1-1: Summary of Urban Stormwater Pollutants	2-7
Table 3.2-1: Summary of Stormwater Standards and Requirements.....	3-3
Table 4.2-1: MOA Design Storm Depths	4-5
Table 4.4-1: Precipitation Loss Methods	4-10
Table 4.4-2: Rational Method Runoff Coefficients	4-11
Table 4.4-3: NRCS (SCS) Curve Numbers	4-12
Table 4.4-4: Depression Storage Values for Conveyance Design	4-13
Table 4.4-5: Depression Storage Values for Water Quality Treatment.....	4-14
Table 4.5-1: Runoff Calculation Methods	4-16
Table 4.5-2: Typical Maximum Infiltration Rate	4-18
Table 4.5-3: Typical Minimum Infiltration Rate.....	4-18
Table 4.5-4: Typical Decay Coefficient.....	4-18
Table 4.6-1: Time of Concentration Equations	4-25
Table 4.6-2 Manning’s Roughness Coefficients for Overland and Sheet Flow.....	4-26
Table 4.6-3 Overland Texture Factor, N, for Yen and Chow Time of Concentration.....	4-27
Table 4.8-1: Common Computer Models	4-30
Table 5.3-1: Manning’s “n” Values for Non-Pressurized Closed Conduits	5-3
Table 6.4-1: Stormwater Controls Selection Guide	6-9
Table 6.6-1: Design Modifications for Bioretention Systems	6-23
Table 6.6-2: Summary of Maintenance Activities for Bioretention Areas.....	6-23
Table 6.6-3: Summary of Maintenance Activities for Soakaway Pits	6-29
Table 6.6-4: Summary of Maintenance Activities for Infiltration Basins.....	6-38
Table 6.6-5: Summary of Maintenance Activities for Infiltration Trenches	6-48
Table 6.6-6: Check Dam Spacing for Design Option 1	6-51
Table 6.6-7: Summary of Maintenance Activities for Vegetated Swales	6-53
Table 6.6-8: Summary of Maintenance Activities for Pervious Pavement.....	6-60
Table 6.6-9: Summary of Maintenance Activities for Chamber Systems	6-67
Table 6.6-10: Summary of Maintenance Activities for Wet Ponds	6-76
Table 6.6-11: Summary of Maintenance Activities for Dry ponds.....	6-83
Table 6.6-12: Summary of Maintenance Activities for Oversized Pipes.....	6-88
Table 6.6-13: Summary of Maintenance Activities for Filter Strips.....	6-97

Table 6.6-14: Wetland Design Criteria.....	6-105
Table 6.6-15: Summary of Maintenance Activities for Constructed Wetlands.....	6-112
Table 6.6-16: Summary of Maintenance Activities for Landscaped Depressions	6-117
Table 6.6-17: Summary of Maintenance for Canopy & Naturally Vegetated Areas	6-122
Table 6.6-18: Average Annual Sediment Loading.....	6-124
Table 6.6-19 Summary of Maintenance Activities for Catch Basins.....	6-125
Table 6.6-20 Standard Storm Statistical Values for Sedimentation Basin Calculations	6-133
Table 6.6-21 Particle Size Distribution of Stormwater Entering a Sed. Basin.....	6-133
Table 6.6-22: Summary of Maintenance Activities for Sedimentation Basins	6-138
Table 6.6-23: Average Annual Sediment Loading.....	6-140
Table 6.6-24: Summary of Maintenance Activities for Oil and Grit Separators	6-142
Table 8.2-1: Recommended Thresholds for Chloride Exposure	8-7

LIST OF FIGURES

Figure 2.1-1: Pre- and Post-Development 10-Year Hydrograph.....	2-3
Figure 2.1-2: Stream Widening and Bank Erosion	2-3
Figure 2.1-3: Stream Downcutting.....	2-4
Figure 2.1-4: Changes in the Channel Bed Due to Sedimentation	2-4
Figure 4.2-1: Intensity-Duration-Frequency Relationships for Anchorage and Eagle River.....	4-2
Figure 4.2-2: Intensity-Duration-Frequency Relationships for Girdwood	4-3
Figure 4.2-3: Orographic Factor Map (Anchorage).....	4-6
Figure 4.2-4: Orographic Factor Map (Eagle River)	4-7
Figure 5.3-1 Outfall to Natural Ground.....	5-11
Figure 6.6-1 a, b, and c: Conceptual Bioretention Profiles.....	6-16
Figure 6.6-2 - Example Overflow Structure for Bioretention Area.....	6-21
Figure 6.6-3: Soakaway Pit Conceptual Drawing	6-25
Figure 6.6-4: Typical Infiltration Basin	6-32
Figure 6.6-5: Infiltration Trench Conceptual Drawing	6-41
Figure 6.6-6: Vegetated Swale Conceptual Layout.....	6-50
Figure 6.6-7: Chamber System Schematic	6-62
Figure 6.6-8: Stormtech Isolator Row Concept.....	6-65
Figure 6.6-9: Typical Wet Pond Design	6-70
Figure 6.6-10: Schematic of a Wet Pond	6-74
Figure 6.6-11: Typical Dry pond	6-78
Figure 6.6-12: Oversized Pipe Schematic.....	6-85
Figure 6.6-13: Manifold Underground Detention System.....	6-86
Figure 6.6-14 Filter Strip Conceptual Plan and Profile.....	6-91
Figure 6.6-15: Sample Cross Section of Concrete Level Spreader	6-96
Figure 6.6-16: Shallow Marsh System.....	6-101
Figure 6.6-17: Pond/Wetland System.....	6-102
Figure 6.6-18: Extended Detention Wetland System	6-103
Figure 6.6-19: Pocket Wetland System.....	6-104
Figure 6.6-20: Comparative Profiles of the Four Stormwater Wetland Design	6-106
Figure 6.6-21: Landscaped Depressions	6-115
Figure 6.6-22: Sedimentation Basin Conceptual Layout.....	6-127

Figure 6.6-23: N Factor and Basin Geometry.....	6-131
Figure 6.6-24: Sedimentation Basin Nomograph 1	6-136
Figure 6.6-25: Sedimentation Basin Nomograph 2	6-137
Figure 6.7-1: Gravel Check Dam.....	6-144
Figure 6.8-1: Riprap Apron Schematic	6-145
Figure 8.2-1: Multiple V-Swale Snow Site Design Concept.....	8-9
Figure 8.2-2: Snow Site Fill Procedure	8-10

ACRONYMS AND ABBREVIATIONS

%.....	Percent
“n”	Manning’s Coefficient
<	Less Than
=	Equals
>	Greater Than
≤	Less Than or Equal To
≥	Greater Than or Equal To
μm	Micron
AAC.....	Alaska Administrative Code
AASHTO	American Association of State Highway and Transportation Officials
Ac	Acre
ADEC.....	Alaska Department of Environmental Conservation
Aka	Also Known As
ADOT&PF	Alaska Department of Transportation and Public Facilities
AMC.....	Anchorage Municipal Code
ANC	Ted Stevens Anchorage International Airport
APDES.....	Alaska Pollutant Discharge Elimination System
ARDSA.....	Anchorage Roads and Drainage Service Area
ASM.....	Anchorage Stormwater Manual
ASTM	American Society for Testing and Materials
AWWU	Anchorage Water and Wastewater Utility
BMP.....	Best Management Practice
BOD	Biochemical Oxygen Demand
C	Rational Method Runoff Coefficient
CFR	Code of Federal Regulations
cfs	Cubic Feet Per Second
CGA	Contributing Grassed Area
CN.....	Curve Number
CPEP	Corrugated Polyethylene Pipe
CWA	Clean Water Act
DCM	Design Criteria Manual

DO	Dissolved Oxygen
DOT&PF.....	Alaska Department of Transportation and Public Facilities
EPA	Environmental Protection Agency
F.....	Fahrenheit
FEMA	Federal Emergency Management Administration
FHWA	Federal Highway Administration
fps.....	Feet per Second
ft.....	Feet
HEC.....	Hydrologic Engineering Center
HMS.....	Hydrologic Modeling System
HRT	Hydraulic Residence Time
IDF	Intensity-Duration-Frequency
in	Inches
lbs.....	Pounds
LID	Low Impact Development
M.A.S.S.....	Municipality of Anchorage Standard Specifications
mg/L.....	Milligrams per Liter
mm	Millimeter
MOA.....	Municipality of Anchorage
MS4	Municipal Separate Storm Sewer System
MSGP.....	Multi-Sector General Permit
NEC.....	National Electric Code
NEH	National Engineering Handbook
NEMA	National Electrical Manufacturers Association
NPDES.....	National Pollutant Discharge Elimination System
NRCS.....	Natural Resources Conservation Service (Formerly SCS)
PCMP.....	Pre-Coated Corrugated Metal Pipe
PM&E	Project Management and Engineering Department Division
ppm	Parts per Million
PVC.....	Polyvinylchloride
RAS	River Analysis System
ROW	Right-of-Way
SCS.....	Soil Conservation Service

sf.....	Square Feet
SOA.....	State of Alaska
SWMM	Storm Water Management Model
T_c	Time of Concentration
TMDL.....	Total Maximum Daily Load
TR-55	Technical Release-55
TSAIA	Ted Stevens Anchorage International Airport (aka ANC)
UH	Unit Hydrograph
UIA.....	Unconnected Impervious Area
US	United States
USDA	United States Department of Agriculture
WMS.....	Watershed Management Services

GLOSSARY

Adverse Impact – Drainage impacts including flooding, erosion, siltation, and degradation of water quality. More specifically, damage to land or structures could be caused by erosion and damage to downstream property or stormwater conveyances could be caused by flooding, icing, erosion, siltation or overtopping. Adverse impact shall be indicated when the analyses performed show increases in runoff volume, peak flow rates, or peak flow duration from the proposed project will cause an increase in water surface elevation, surcharge, backwater, flooding, erosion, sedimentation, or icing due to project flows.

Alaska Pollution Discharge Elimination System Permit – The permit issued by the State of Alaska that allows the MOA and ADOT&PF to discharge stormwater into Cook Inlet.

Bioretention – A soil and plant-based stormwater management facility used to filter runoff via infiltration. Also provides micro-detention/retention storage.

Buffer – A vegetative setback between development and streams, lakes, or wetlands to physically protect and separate the water resource from future disturbance or encroachment.

Catchment Area –The total area contributing stormwater runoff to a particular point, site, or structure.

Cleanout – An access point in an underground storm drain system to allow periodic removal of any collected sediment or debris.

Common Plan of Development – For the purposes of this manual, means a site where multiple separate and distinct construction activities may be taking place at different times on different schedules, but still under a single plan. Examples include: 1) phased projects and projects with multiple parcels or lots, even if the separate phases or parcels/lots will be constructed under separate contracts or by separate owners (e.g., a development where lots are sold to separate builders); or 2) projects in a contiguous area that may be unrelated but still under the same contract, such as construction of a building extension and a new parking lot at the same facility. If the project is part of a common plan of development or sale, the disturbed area of the entire plan shall be used in determining permit requirements.

Where discrete construction projects within a larger common plan of development or sale are located one-quarter mile or more apart and the area between the projects is not being disturbed, each individual project can be treated as a separate plan of development or sale provided any interconnecting road, pipeline or utility project that is part of the same “common plan” is not being disturbed. If a utility company is constructing new trunk lines off an existing transmission line to serve separate residential subdivisions located more than one quarter mile apart, the two trunk line projects could be considered to be separate projects.

Construction General Permit – A National Pollutant Discharge Elimination System permit that authorizes and regulates discharges of stormwater and certain other types of wastewater from construction sites.

Conveyance System – The drainage facilities, both natural and human-made, which collect, contain, and provide for the flow of surface water and runoff. Natural conveyance system elements include swales

and small drainage courses, streams, rivers, lakes, and wetlands. Human-made conveyance system elements include gutters, ditches, pipes, channels, and retention/detention facilities.

Culvert – Culverts are hydraulic conduits used to convey stormwater or stream flow from one side of a road, driveway, median, or other entity to the other. Culverts are generally a single run of pipe (no lateral connections) or a box section that is open at both ends.

Curb Mile – Curb Mile is the length of actual curb in miles. For example, if a one-mile section of roadway has curb on both sides, the curb mile length would be two miles. If roadway drainage is provided through ditches or swales in lieu of curb, there is no curb mile associated with the roadway.

Curve Number – Numerical value used to determine quantity of runoff resulting from rainfall for a specific land area based on the area's hydrologic condition, land use, soil, and treatment.

Design Storm – A rainfall event of specific duration, intensity, and return frequency (e.g., the 2-year, 24-hour storm) that is used to calculate runoff volume and peak discharge rate for hydrologic analysis and infrastructure design. Any Municipally-approved rainfall event (and associated precipitation volume) directly based on analysis of data collected by the National Weather Service station located at the Ted Stevens Anchorage International Airport.

Detention – Temporary storage of runoff for later, controlled release.

Detention Basin – A storage facility which intercepts, stores, and gradually releases stormwater downstream at a reduced peak discharge rate, with little effect on the overall runoff volume. Detention can be an excavated pond, enclosed depression, or a tank. Detention is used for pollutant removal, stormwater storage, and peak flow reduction.

Directly Connected Impervious Area – The impervious portion of a site that drains directly to the storm drain system (as opposed to draining to a pervious area).

Downstream Conveyance Route – The actual flow route taken by some or all post-development surface runoff flows from a project discharge point to the first receiving water or to tidewater.

Drainageway – A watercourse that does, or under developed conditions, is likely to, convey stormwater flows. Drainageways are characteristically ephemeral, conveying flows only in direct response to stormwater runoff and for limited durations. Drainageways may be identified along undeveloped land, even if surface flows do not currently occur, if it can be reasonably shown that constructed or natural drainageways likely will be required to convey storm flows, or will naturally develop as a result of increased runoff due to anticipated future land development. Drainageways do not carry perennial flows except when these flows result from contributions from constructed subsurface or other human-induced drainage (e.g., foundation drains, ditches, or storm drains that intercept groundwater). Drainageways may exist naturally along topographic flow lines or they may be constructed.

Erosion Control Measures – Source controls used to limit erosion of soil at construction sites and other erosion-prone areas. Representative measures include surface treatments that stabilize soil that has been exposed due to excavation or grading and flow controls that redirect flows or reduce velocities of concentrated flow.

Evaporation – The process by which water is transferred from the earth's surface to the atmosphere.

Fetch – The area of ocean or lake surface over which the wind blows in an essentially constant direction, thus generating waves. The term also is used as a synonym for fetch length, which is the horizontal distance over which wave-generating winds blow.

Floodplain – Land adjacent to a drainageway which is inundated when the discharge exceeds the conveyance capacity of the normal channel; it's often defined in a regulatory sense as the extent of the 100-year flood.

Flow Attenuation – To reduce the magnitude of peak runoff flows.

Forebay – An extra storage space provided near an inlet of a structural stormwater control to trap incoming sediments before they accumulate in the facility.

Freeboard – The vertical distance between the level water surface and the lowest point along the top of a structure, such as a berm, that impounds or restrains the water.

Grass Buffer – Uniformly graded and densely vegetated area, typically turf grass. Requires sheet flow to promote filtration, infiltration, and settling to reduce runoff pollutants. May be used to disperse concentrated flows.

Grass Swale – Densely vegetated drainageway with low-pitched side slopes that collects and slowly conveys runoff. The design of the longitudinal slope and cross-section size forces the flow to be slow and shallow, thereby facilitating sedimentation while limiting erosion.

Groundwater Mounding – Elevation of the water table as a result of infiltrated surface water.

Heat Sink – Any material or facility that is used to store or absorb heat.

Hotspot – A land use or activity on a site that produces higher concentrations of trace metals, hydrocarbons or other priority pollutants than are normally found in urban stormwater runoff. Examples of hotspots include gas stations, vehicle service and maintenance areas, salvage yards, material storage sites, garbage transfer facilities, and commercial parking lots with high-intensity use.

Impervious Area – A hard surface area (e.g., parking lot or rooftop) that prevents or retards the infiltration of water into the soil, thus causing water to run off the surface in greater quantities and at an increased rate of flow relative to pervious areas.

Impervious Collar – Refers to an impervious barrier constructed around the walls of a soak-away pit. The intent of the impervious collar is to provide a clear hydraulic divide between the wall of the soak-away pit and adjacent structures. The impervious collar may be constructed out of a variety of materials as long as this intent is met.

Infiltration – The percolation of water from the land surface into the ground.

Initial Abstraction – The amount of precipitation that must fall before surface excess results and runoff occurs. The losses occur due to interception (precipitation that merely wets above-ground objects) and depression storage. It differs from the initial loss in that the initial abstraction affects the infiltration later in the storm as well.

Intensity-Duration-Frequency Curves (IDF) – Graphical representation of intensity, duration, and frequency of different rainfalls.

Land Disturbance Area - A portion of any site in which the landscape is altered from pre-existing conditions, including but not limited to the following: grubbing and clearing of vegetation, grading, earth moving, altering land forms, soil compaction, and other activities that will result in changes to runoff volumes, rates, temperature, and duration of flow. If a project is part of a common plan of development, see definition of Common Plan of Development for explanation of the Land Disturbance Area.

Low Impact Development (LID) – An overall land planning and engineering design approach to managing stormwater runoff. LID emphasizes conservation and use of on-site natural features to protect water quality. This approach implements engineered small-scale and distributed hydrologic controls to mimic the pre-development hydrologic regime of watersheds through infiltrating, filtering, storing, evaporating, and detaining runoff close to its source.

Major Drainageway – A drainageway with a contributing area of more than 40 acres.

Media Filter – A stormwater control designed to filter runoff as it passes through media such as sand, compost, sand-peat, or similar materials.

Micropool – A smaller permanent pool incorporated into the design of larger stormwater ponds to reduce potential of clogging of the outlet and minimize re-suspension of sediment.

Minor Drainageway – A drainageway with a contributing area less than or equal to 40 acres.

Municipal Separate Storm Sewer System (MS4) - A publicly-owned conveyance system that collects or conveys runoff and discharges to waters of the U.S. It is not part of a publicly owned treatment works. The MOA operates an MS4 system under regulations from the EPA. These regulations are outlined in the MOA's MS4 permit (or NPDES permit).

MS4 Permit – A state or federal stormwater discharge permit to regulate discharges from municipal separate storm sewer systems (MS4s) for compliance with Clean Water Act regulations.

National Pollutant Discharge Elimination System (NPDES) – The national program under Section 402 of the Clean Water Act for regulation of discharges of pollutants from point sources to waters of the U.S.

New Development – Land disturbing activities, structural development (construction, installation or expansion of a building or other structure), and/or creation of impervious surfaces on a previously undeveloped site.

Ordinary High Water Mark – The elevation marking the highest water level which has been maintained for a sufficient time to leave evidence upon the landscape. Generally, it is the point where the natural vegetation changes from predominately aquatic to upland species. For streams, the OHW is generally the top of the bank of the channel.

Orographic Factor – A multiplier applied to adjust base precipitation data obtained from a single permanent weather station to fit local conditions.

Outfall – A point at which runoff carried by project conveyances, or generated within a project drainage area, exit the project.

Pea Gravel – Non-fractured, washed gravel with a particle size ranging from 0.25 inches to 0.5 inches in diameter.

Peak Runoff Rate – The highest actual or predicted flow rate (typically measured in cubic feet per second) for runoff from a site for a specific event.

Permeable Pavement System – A general term to describe pavement designed to allow infiltration of water from the paved surface into subsurface layers. Depending on the design, permeable pavements can be used to promote volume reduction, provide treatment and slow release of runoff, and/or reduce effective imperviousness. Permeable pavement systems include permeable interlocking concrete pavement, concrete grid, pervious concrete, porous asphalt, reinforced grass, porous gravel, and other materials.

Perennial Stream Flow – A stream flow that occurs throughout the year, except for extended periods of drought or cold.

Plug Flow – A type of flow that occurs in tanks, basins, or reactors when a slug of water moves through without ever dispersing or mixing with the rest of the water flowing through.

Pre-Development – Reflects the current conditions of the project area prior to the construction of the proposed project. This includes existing natural conditions as well as existing development and infrastructure on redeveloping sites.

Project Area – The area encompassed by all platted land parcels that ultimately will be developed, modified, or included under a specific plan of action that may be comprised of multiple phases.

Pollutant – A contaminant in a concentration or amount that adversely alters the physical, chemical, or biological properties of the natural environment. Consists of any of the following discharged into water: dredged spoil, solid waste, incinerator residue, filter backwash, sewage, garbage, sewage sludge, munitions, chemical wastes, biological materials, radioactive materials, heat, wrecked or discarded equipment, rock, sand, cellar dirt, and industrial, municipal, and agricultural waste [40 CFR 122.2].

Post-Development – Reflects all physical changes within the project area due to the construction of the proposed project.

Project Discharge Point – Any point at which surface flows carried by project conveyances, or generated within a project drainage area, exit the project.

Rainfall Distribution – Describes how the rain depth is distributed over a specified time period (i.e., 24-hours).

Rain Garden – Also known as a bioretention facility or porous landscape detention, this stormwater quality facility consists of a depressed vegetated area with surface storage underlain by a permeable soil media and an optional subdrain contained in the drain rock layer. A shallow surcharge zone exists above the porous landscape detention for temporary storage of runoff.

Redevelopment – The alteration, renewal or restoration of any developed land or property that results in the land disturbance of 10,000 square feet or more, and that has one of the following characteristics: land that currently has an existing structure, such as buildings or houses; or land that is currently covered with an impervious surface, such as a parking lot or roof; or land that is currently degraded and is covered with sand, gravel, stones, or other non-vegetative covering.

Reference Reach – A segment of a drainageway that represents a stable channel (dimension, pattern, profile) within the area’s geomorphic context. It can consist of a natural channel or a stable, modified condition.

Regulated Stream – Any watercourse along which the flood hazard areas have been mapped and approved by the Federal Emergency Management Agency, or any stream designated as regulated by the MOA PM&E Department.

Retention – Prevention of runoff. Stormwater is retained and remains indefinitely, with the exception of the volume lost to evaporation, plant uptake or infiltration.

Retention Basin – A storage facility which prevents runoff by intercepting, storing, and gradually infiltrating stormwater into the underlying soil. Retention can be an excavated pond, enclosed depression, or subsurface infiltration system. Retention is used for pollutant removal, enhanced sedimentation, stormwater storage, volume reduction, and peak flow reduction. These facilities may also be designed to have an aesthetic and/or recreational value.

Return Frequency – Also called recurrence interval, the statistical probability that a specific storm event will occur in any given year. For example, the 100-year, 24-hour event has a one percent or one in 100 chance of being equaled or exceeded in any given year, whereas the 2-year, 24-hour event has a 50 percent or one in two chance of being equaled or exceeded in any given year.

Riparian Areas – Areas adjacent to a water body acting as transition zones between terrestrial and aquatic systems.

Runoff – Water from rain, melted snow, or irrigation that flows over the land surface.

Runoff Coefficient – Rational Method Runoff Coefficient calculated according to guidance contained in this manual.

Sheet Flow – The portion of precipitation that flows overland in very shallow depths before eventually reaching a stream channel or other conveyance.

Short-Circuiting – The reduction in residence time in the basin due to flow path shortening, which reduces the pollutant removal efficiency.

Slope Ratio – the ratio of the culvert bed slope to the upstream reach or reference reach channel slope.

Soak Away Pit – A type of structural stormwater control which consists of small, excavated pits backfilled with aggregate and used to infiltrate higher quality stormwater runoff (e.g., from an uncontaminated roof). It is a type of dry well that does not qualify as a Class V injection well according to EPA regulations.

Soil Amendment – A material added to or mixed into soil to improve plant growth and health and enhance long-term infiltration. It corrects the existing soil's deficiencies in structure and/or nutrients. May include compost, sand, or other materials.

Stabilization – A surface treatment that prevents the erosion of soil. Stabilization includes uniform perennial vegetation with at least 70 percent vegetative cover, native vegetative cover, pavement, permanent structures; or equivalent permanent features such as gravel, riprap, gabions, or geotextiles.

Storm Drain System – A conveyance system consisting of storm drain pipes which convey stormwater, such as pipes within the existing municipal separate storm drain system.

Stormwater – Stormwater runoff, snow melt runoff, and surface runoff and drainage.

Stream – A watercourse perennially or intermittently conveying waters not solely the result of constructed subsurface drainage. When a stream does flow, it conveys more water than that contributed from a single storm event. In Municipal mapping, each stream exists as a non-branched watercourse with only one headwater source and one outlet or mouth, but any stream may have one or more tributary streams associated with it that contribute to its flow. A natural stream displays a bed and banks except that these features may not be present locally where flow is intermittent (either spatially or temporally), or where the stream has been piped or otherwise substantially modified. Thus, a stream retains its identity as a single continuous feature over its whole length even though its flow may periodically break up and disappear along its alignment. A stream's continuity from reach to reach is established through a reasonable demonstration of its actual or historic continuity of flow (perennially or intermittently) and its continuity along contiguous topographic flow lines.

Stream Order – A stream network classification system that designates first order streams as 'fingertip' headwater features at the source of a stream network; a second order stream as the feature resulting from the confluence of two first order streams; a third order stream as the feature resulting from the confluence of two second order streams, etc. Stream order designations for MOA stream mapping are developed and assigned by the Project Management and Engineering Department's Watershed Management Services (WMS) and proposed ordering of streams not yet mapped must be approved by WMS.

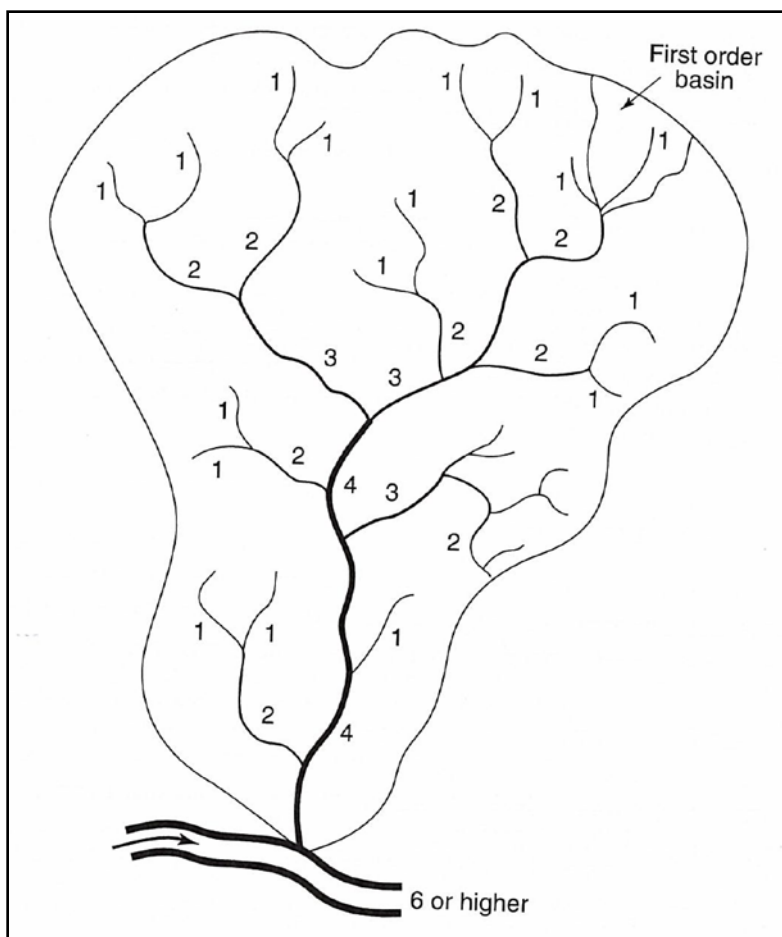

Source: *Water Resources Engineering, 2005*

Structural Stormwater Controls – Engineered facilities intended to treat stormwater runoff and/or mitigate the effects of increased stormwater runoff peak rate, volume, and velocity due to urbanization.

Subdrain (For LID and Green Infrastructure applications) – An underground, perforated pipe or system of pipes which collect runoff that has infiltrated through the soil from an LID such as a rain garden; the runoff is routed through the pipe to a storm drain system or outfall. A subdrain is typically four to six inches in diameter, placed longitudinally at the invert of a stormwater facility for the purposes of achieving a desired discharge rate and controlling ponding.

Subdrain (Conventional) – An underground perforated pipe or system of pipes that are typically intended to collect and convey groundwater away from roadways, building foundations, or other structures. Conventional subdrains within municipal rights-of-way are typically not less than 10-inches in diameter.

Subwatershed – A subdivision based on a hydrology corresponding to a smaller catchment within a larger watershed.

Surface Water – Water that remains on the surface of the ground, including rivers, lakes, reservoirs, streams, wetlands, impoundments, seas, estuaries, etc.

Transpiration – The process by which moisture is carried through plants from roots to small pores on the underside of leaves, where it changes to vapor and is released to the atmosphere. Transpiration is essentially evaporation of water from plant leaves.

Trash Rack – Grill, grate or other device installed at the intake of a channel, pipe, drain, or spillway for the purpose of preventing oversized debris from entering the structure. Trash racks may also serve a safety function.

Tidewater – The coastal boundary in Municipal digital mapping; approximately the mean higher high water line. Thus this boundary generally reflects the approximate landward extent of tidal influence on the geologic and biologic character of terrestrial lands. The coastal boundary delineates the landward edge of Municipal coastlands (where no coastlands are present, this boundary coincides with the Municipal shoreline).

Tributary – A stream whose outlet is located along the course of another stream; a stream that flows into another stream.

Unconnected Impervious Area (UIA) – The impervious portion of a site that drains over a receiving pervious area before discharging to the storm drain system. UIA is a key component of the conceptual model used in volume reduction calculations. Also referred to as disconnected impervious cover.

Water Budget – An accounting of the inflows to, the outflows from, and the storage changes of water in a hydrologic unit or system such as a watershed or aquifer.

Watercourse – A natural channel produced wholly or in part by the flow of surface water, or any artificial channel constructed for the conveyance of surface water. Also, any topographic flow line that either does, or under developed conditions is likely to, accumulate and convey substantial stormwater flows. Also, any conveyance, whether an open channel or closed conduit, constructed wholly or in part for the transport of stormwater runoff. Watercourses include all surface water conveyance features and can be further classified under the Municipal classification system as either streams or drainageways.

Waters of the United States – All waters that are currently used, were used in the past, or may be susceptible to use in interstate or foreign commerce, including all waters subject to the ebb and flow of the tide. Waters of the U.S. include all interstate waters and intrastate lakes, rivers, streams (including intermittent streams), mudflats, sand flats, wetlands, sloughs, prairie potholes, wet meadows, playa lakes, or natural ponds.

Watershed – A geographical area that drains to a specified point on a water course, usually a confluence of streams or rivers (also known as drainage area, catchment, or river basin).

Wetland – Areas that are saturated by surface or groundwater at a frequency and duration that supports a prevalence of vegetation adapted for life in saturated soil conditions. Wetlands generally include areas such as swamps, marshes, and bogs.

Zone of Influence – The zone of influence refers to the area of the surrounding subgrade that is critical to proper function and support of the overlying and/or adjacent foundation or road subgrade. Generally, the zone of influence can be defined as the area bounded within a three-dimensional surface extending at a 1:1 (horizontal : vertical) slope down and away from the outer edge of a foundation or road subgrade.

1.0 INTRODUCTION

1.1 Objective of This Manual

The manual provides design criteria and guidance for managing stormwater runoff within the Municipality of Anchorage (MOA). (Exceptions to applicability of this manual are discussed in Section 1.4.2.) This guidance includes:

- A. Hydrologic guidelines and parameters for estimating stormwater runoff volume and rates,
- B. Stormwater conveyance design criteria (open channel and closed conduit systems),
- C. Design Criteria for structural stormwater controls,
- D. Better Site Design practices, and
- E. Energy dissipation methods.

The overall goals of this criteria manual are to provide safe, adequate drainage without adverse impacts to others and to provide water quality treatment for stormwater water runoff to the maximum extent practicable. In some cases, the language in this manual is discretionary to provide flexibility in meeting these goals. However, the MOA reserves the right to enforce all criteria as prescriptive when the MOA determines that this is in its best interest and better supports the above-described goals.

1.2 Related Guidance

This manual, the *Anchorage Stormwater Manual (ASM) Volume One*, provides specific drainage-related design requirements, considerations, and hydrologic and hydraulic methods. The *ASM Volume Two – Construction Practices* presents information and establishes standards related to minimizing impacts to land and water resources during construction. Together, the ASM Volumes 1 and 2 supersede or replace the following previously adopted MOA manuals:

- A. Previous versions of the Design Criteria Manual Chapter 2 (superseded)
- B. Previous versions of the Stormwater Treatment Plan Review Guidance Manual (superseded)
- C. MOA Drainage Design Guidelines, 2008 (replaced)
- D. Low Impact Development Guidance Manual (replaced)

All referenced documents, which are included or incorporated by reference in this manual, shall be the latest edition, unless otherwise noted.

1.3 How To Use This Manual

Below is a brief description of each of the sections in this manual.

Section 1 – Introduction: Introduces the manual and provides guidance regarding how to use the manual effectively. This section also discusses the regulatory requirements that govern stormwater management for the MOA.

Section 2 – Overview of Stormwater Management: Provides information regarding stormwater

management and planning. This section describes the effect of development on runoff, drainageways, and the areas adjacent to drainageways (e.g., riparian areas, habitat, wetlands).

Section 3 – Stormwater Management Requirements: Contains the MOA requirements for stormwater management. This section describes project classifications and describes the stormwater management requirements for development and re-development.

Section 4 – Estimating Stormwater Runoff: Presents methods for quantitative estimation of stormwater runoff. This includes information such as rainfall data, design storms, precipitation loss information, calculation methods, and routing options.

Section 5 – Conventional Stormwater Facilities: Introduces conventional stormwater facilities and the specific criteria associated with each type of infrastructure. Specific types of facilities discussed include piped storm drain systems, drainage infrastructure for streets, open channels, erosion protection for streams, restoration of streams, and icing control design.

Section 6 – Structural Stormwater Controls: Presents detailed information about structural stormwater controls including benefits, limitations, design information, construction considerations, and maintenance guidelines. Specific structures include bioretention facilities, soakaway pits, infiltration basins, infiltration trenches, vegetated swales, pervious pavement, chamber systems, wet ponds, dry ponds, oversized pipes, filter strips, constructed wetlands, landscaped depressions, canopy cover and natural vegetation retention, sedimentation basins, and oil and grit separators. Energy dissipation methods are also discussed.

Section 7 – Better Site Design Practices: Introduces better site design practices and includes details of several better site design techniques such as parking lot islands, buffers, vegetated swales, and draining runoff to pervious areas. This section also recommends resources for additional information regarding better site design.

Section 8 – Snow Storage Requirements: Presents design criteria for snow storage facilities.

Section 9 – References: Contains a list of works cited in this manual as well as resources referenced during the development of the manual.

1.4 Regulatory Requirements for Pollution Prevention

The MOA is required to manage stormwater within municipal boundaries by Federal statutory regulations contained in the Clean Water Act (CWA), and regulatory requirements contained in the Environmental Protection Agency's (EPA's) National Pollutant Discharge Elimination System (NPDES) permit program. The MOA is also required to manage stormwater and associated pollutants in accordance with specific requirements set forth in the Alaska Administrative Code (AAC) and the Anchorage Municipal Code (AMC). The Stormwater Management Requirements for development and re-development presented in Section 3.3 of this manual include the current regulatory requirements mandated by the EPA.

1.4.1 EPA National Pollutant Discharge Elimination System (NPDES) Permit Program

As authorized by the CWA, the EPA's NPDES permit program controls water pollution by regulating point sources that discharge pollutants into waters of the United States. Point sources are specific discharges such as pipes or constructed ditches. Since its introduction in 1972, the NPDES permit program has been responsible for significant improvements to our nation's water quality.

Per the CWA, states are intended to run the NPDES program; however, provisions are included for EPA to do so when states elect not to. The State of Alaska (SOA), Department of Environmental Conservation (ADEC) implemented an EPA-approved program, the Alaska Pollutant Discharge Elimination System (APDES) program. Stormwater regulation authority was transferred to ADEC on October 31, 2009. When this occurred, existing EPA stormwater permits were transferred to ADEC. The permits will remain in effect until ADEC issues APDES permits to replace the EPA-issued permits. ADEC will monitor and enforce compliance.

The EPA will oversee the state's implementation of the APDES program and can intervene on any permit issued, renewed or modified by the state. The EPA will also continue to exercise certain responsibilities involving Tribes and other federal agencies.

1.4.1.1 Design Drainage Related Permits

Within the APDES permit program, there are two permits that apply to the regulation of stormwater discharges and associated pollutants. These two permits include the following:

- 1) Municipal Separate Storm Sewer System (MS4) Permit No. AKS-052558 – applies to municipal separate storm drain systems. The MOA and the Alaska Department of Transportation and Public Facilities (DOT&PF) are co-permittees under an MS4 permit issued by the EPA and now administered by ADEC. The MS4 permit allows the MOA and DOT&PF, as operators of a MS4, to discharge stormwater meeting specified requirements into waters of the United States.
- 2) Multi-Sector General Permit (MSGP) No. AKR060000 – applies to post-construction stormwater discharges and potential pollutants at industrial facilities.

1.4.1.2 Construction Drainage Related Permits

Additional permits that relate to construction practices are discussed in the ASM Volume Two Construction Practices and in Chapter One (Streets) of the MOA DCM.

1.4.2 Non-Applicability

The stormwater treatment requirements presented in this manual do not apply to public systems that have individual treatment programs. These include but are not limited to Anchorage International Airport, The Port of Anchorage, and JBER.

The stormwater management requirements presented in this manual generally do not apply to single lot, single family or duplex construction that is not part of a common plan of development.

1.4.3 Local and State Codes Related to Stormwater

- AMC Title 21 Land Use Planning. This title has several chapters that deal with the requirement for storm drainage construction for private development.
- AMC Title 23 Building Codes. This title has several chapters that deal with various building regulations.
- AMC Title 24 Streets and ROW. This title has several chapters that deal with construction within street Right-of-Way (ROW) and public places.
- State of Alaska 18 AAC 70 Water Quality Standards. This chapter provides standards for water quality.
- State of Alaska 18 AAC 72 Wastewater Disposal. This chapter requires plan reviews for all non-domestic waste treatment and discharge systems.

1.5 Municipal Stormwater Policies

The purpose of MOA stormwater policies is to ensure that stormwater management is provided with land development activities. Responsible stormwater management is the treatment, retention, detention, infiltration, and conveyance of stormwater and other surface waters without adversely impacting adjoining, nearby, or downstream properties and/or receiving waters. The following objectives and policies shall be followed during site development.

- A. The system shall follow drainageways and drainage basins as established in current MOA Watershed Management Services (WMS) mapping and area drainage studies, or, where no mapping or drainage study information exists, along existing drainageways and natural drainage swales and divides. Stream and drainage features used in drainage analyses shall be approved by WMS.
- B. If drainage is directed offsite or out of the ROW, it must be directed into an established natural water course or an existing storm drainage facility. In cases where municipal drainage systems are not available or if the designer elects to keep project runoff onsite, the project must keep and manage onsite runoff generated from the required conveyance design storms.
- C. If drainage is managed on-site, it must be demonstrated that on-site systems are adequate for site conditions both now and throughout the system's life expectancy with no adverse impacts to the site or to adjacent properties.
- D. There shall be no adverse impacts on existing drainage or on a downstream property or watercourse, except as provided for below. All adverse impacts shall be addressed through addition of infiltration, retention, and/or detention controls within the project or through correction of downstream conveyance limitations or problems sufficient to achieve compliance with the Stormwater Management Requirements presented in this manual.
- E. Flow that originates within or passes through a municipal right-of-way or easement may not be directed onto private property unless an easement is granted by the property owner. Any water that flows along a water course or drainageway that is to be maintained by the MOA must be located in an easement. Easements may also be required in situations where other organizations,

such as homeowners associations, are responsible for maintenance.

- F. Where flow from a proposed system that may create adverse impacts is directed across property lines, a notarized letter of non-objection shall be obtained from the owner of any downstream property that could be affected. Concentrated drainage flows shall not be discharged onto downstream properties unless the owner of the affected land has granted an easement or letter of non-objection (see above bullet for discussion of easements) expressly authorizing such discharge. Exceptions may be granted by the MOA upon request if the discharge is into an established natural drainage way or other watercourse (such as a creek) and the designer demonstrates that the facility is capable of handling the additional runoff without causing flooding, icing, erosion, or siltation on adjacent properties or otherwise adversely impacting the watercourse on adjacent properties.
- G. Natural and constructed drainageways shall be incorporated into development designs as drainage collectors, collecting runoff from adjacent properties. Drainage structures shall be constructed and appropriate easements established for both constructed and natural drainageways so that they are accessible to maintenance personnel and can be maintained at a reasonable cost, as determined by the Street Maintenance Department. Easements shall be in place or acquired by the proposed project.
- H. Drainage and cut bank impacts on existing on-site septic systems affected by the project shall be mitigated in land development, re-development, road, and drainage projects.
- I. Improvements shall be designed and constructed in a manner that minimizes the potential for icings in streams, or constructed or natural drainageways.
- J. Drainage patterns shall not be altered in a manner that impedes runoff from adjoining property or otherwise causes an accumulation of water or reduction in flow capacity that may impact drainage from or into adjacent properties.
- K. For new construction, roof drainage concentrated by downspouts or similar devices shall not be directed toward urban streets (without ditches) or toward other impervious surfaces intended for public walking or driving.
- L. Driveways and buffer areas of commercial projects or residential projects of triplex size or greater shall be designed so that no surface drainage originating off of the right-of-way is permitted to drain onto the traveled way of a municipal public road. This applies to all municipal rights-of-way and to private roads that may potentially become owned or maintained by the municipality in the future. This does not apply to private, onsite grading and drainage routing.
- M. These design criteria and other references herein present the Stormwater Management Requirements for projects under the jurisdiction of the MOA. At the sole discretion of the Municipal Engineer, the MOA may impose greater standards and criteria when deemed appropriate to protect the safety and welfare of the public.

1.6 Drainage Design Variances

This manual presents the minimum requirements for stormwater management. Whether expressly stated or not, throughout the criteria, any deviation from these standards in which the minimum requirements are not met shall require a written variance from the Municipal Engineer. Variance is not required for

deviations in which these minimum requirements are exceeded. Approval of plans containing deviations from the criteria shall not constitute tacit approval of the deviation or approval of a design variance.

- 1) Request Submittal: Variance requests shall be in writing and shall contain information, justification and suggested resolutions. Variances shall be approved prior to submittal of applicable plans and/or the reports.
- 2) Documentation: Variance requests shall include complete discussion and documentation supporting proposed methods and parameters. Documentation must include citations of current research and manuals of practice published or sponsored by well-known, credible public and private agencies. Complete copies of supporting documentation must be provided as part of the application. Economic hardship shall not be adequate justification for a variance.
- 3) Justification: Variance requests shall include compelling technical arguments for using the proposed method or parameter as an alternate to what is required.
- 4) Review: The Municipal Engineer will consider variance requests and accept or deny the request in writing. Appeal of decisions regarding variances shall follow the procedures detailed on the MOA website in Policy and Procedures Number 10, “Contesting and Appealing Decisions” (found at www.muni.org).

2.0 OVERVIEW OF STORMWATER MANAGEMENT

2.1 The Need for Stormwater Management

2.1.1 Impacts of Development and Stormwater Runoff

Land development changes the physical, biological, chemical, and conditions of Anchorage’s waterways and water resources. This section describes the changes that occur due to development and the resulting stormwater runoff impacts.

2.1.2 Development Changes Land and Runoff

When land is developed, the hydrology, or the natural cycle of water is disrupted and permanently altered. Clearing and grubbing removes the vegetation that intercepts, slows and returns rainfall to the air (through evaporation and transpiration). Grading flattens hilly terrain and fills in natural depressions that slow and provide temporary storage for rainfall. The topsoil is scraped and removed and the remaining subsoil is compacted. Rainfall that once seeped into the ground now runs off the surface. The addition of buildings, roadways, parking lots, and other surfaces that are impervious further reduces natural infiltration and increases runoff. Development and impervious surfaces also reduce the amount of water that infiltrates into the soil and groundwater, thus reducing the amount of water that can recharge aquifers and feed stream flow during periods of dry weather.

Depending on the magnitude of changes to the land surface, the total runoff volume can dramatically increase. These changes not only increase the total volume of runoff, but they also increase the rate at which runoff flows across the land. This effect is compounded by the addition of drainage systems such as gutters and storm drains that are designed to quickly carry runoff to rivers and streams.

Development and urbanization affect not only the quantity of stormwater runoff, but also its quality. Development increases both the concentration and types of pollutants carried by runoff. As it flows over rooftops and lawns, parking lots and industrial sites, stormwater picks up and transports a variety of contaminants and pollutants to downstream waterbodies. The loss of the original topsoil and vegetation removes a valuable filtering mechanism for stormwater runoff.

The cumulative impact of development and urban activities, and the resulting changes to both stormwater quantity and quality determines the conditions of the waterbody. The land area that drains to the waterbody is known as its *watershed*. Urban development within a watershed has a number of direct impacts on downstream waters and waterways. These impacts include:

- ~ Changes to stream flow,
- ~ Changes to stream geometry,
- ~ Degradation of aquatic habitat, and
- ~ Water quality impacts.

The rest of this section explains each of these impacts in further detail and discusses ways to mitigate their effects.

2.1.3 Changes to Stream Flow

Urban development alters the hydrology of watersheds and streams by disrupting the natural water cycle. This results in:

- A. Increased Runoff Volumes – Land surface changes can dramatically increase the total volume of runoff generated in a developed watershed.
- B. Increased Peak Runoff Discharges – Increased peak discharges for a developed watershed can be two to five times higher than those for an undisturbed watershed. See Figure 2.1-1.
- C. Greater Runoff Velocities – Impervious surfaces and compacted soils, as well as improvements to the drainage system such as storm drains, pipes and ditches, increase the speed at which rainfall runs off land surfaces within a watershed.
- D. Timing – As runoff velocities increase, it takes less time for water to run off the land and reach a stream or other water body.
- E. Increased Frequency of Bankfull and Near Bankfull Events – Increased runoff volumes and peak flows increase the frequency and duration of smaller bankfull and near bankfull events which are the primary channel forming events.
- F. Increased Flooding – Increased runoff volumes and peaks also increase the frequency, duration and severity of out-of-bank flooding.
- G. Lower Dry Weather Flows (Baseflow) – Reduced infiltration of stormwater runoff causes streams to have less baseflow during dry weather periods and reduces the amount of rainfall recharging groundwater aquifers. Also, in wetland areas baseflow from the drainage area or groundwater must be sufficient to maintain a shallow pool and support the vegetation, including species susceptible to damage during dry periods.

Figure 2.1-1: Pre- and Post-Development 10-Year Hydrograph

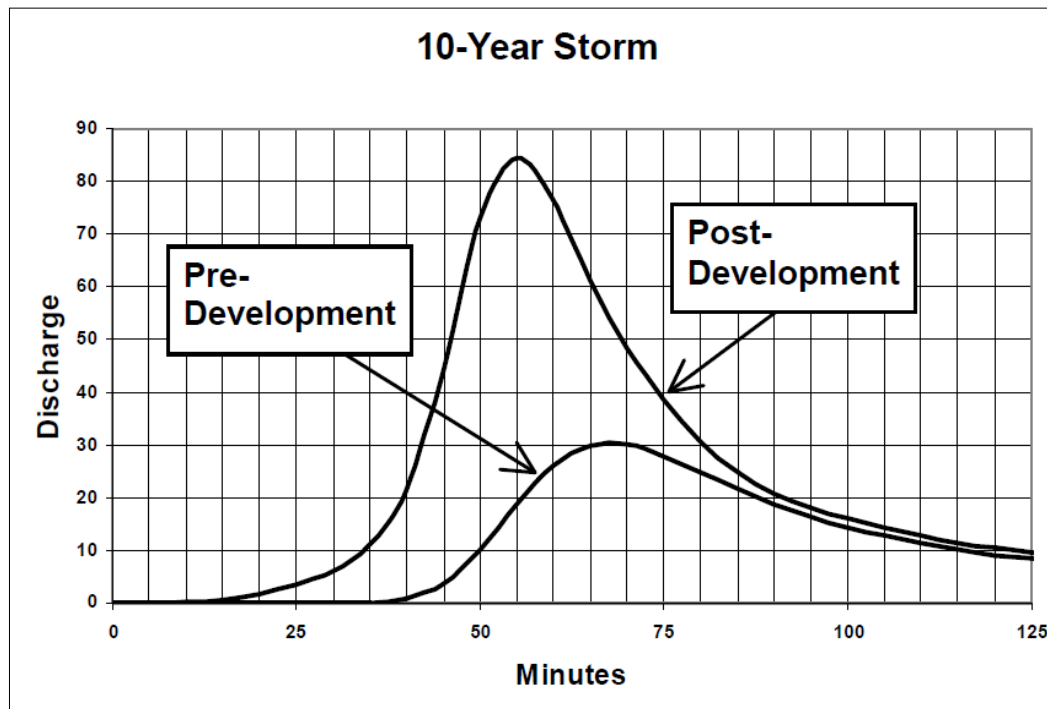

Source: Georgia Stormwater Management Manual, Volume 2, 2001

2.1.4 Changes to Stream Geometry

The changes in the rates and amounts of runoff from developed watersheds directly affect the morphology, or physical shape and character, of Alaska’s streams and rivers. Some of the impacts due to urban development are described below.

- A. *Stream Widening and Bank Erosion* – Stream channels widen to accommodate and convey the increased runoff and higher stream flows from developed areas. More frequent small and moderate runoff events undercut and scour the lower parts of the streambank, causing the steeper banks to slump and collapse during larger storms. Higher flow velocities further increase streambank erosion rates. A stream can widen many times its original size due to post-development runoff. Stream widening is illustrated in Figure 2.1-2.

Figure 2.1-2: Stream Widening and Bank Erosion

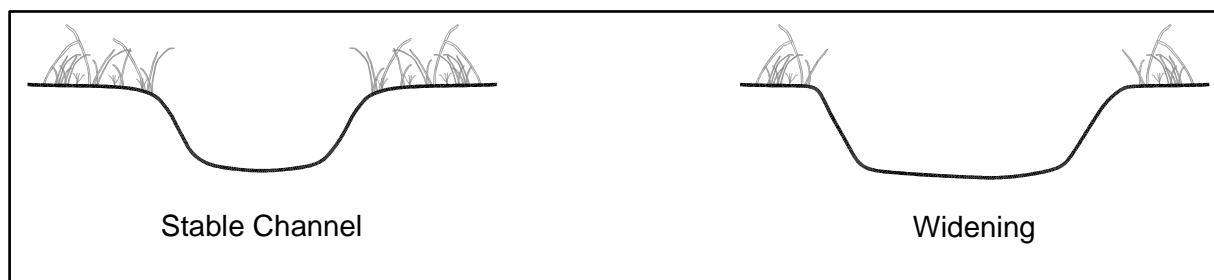

- B. *Stream Downcutting* – Another way that streams accommodate higher flows is by downcutting their streambed. This causes instability in the stream profile, or elevation along a stream’s flow path, which increases velocity and triggers further channel erosion both upstream and downstream. Downcutting is illustrated in Figure 2.1-3.

Figure 2.1-3: Stream Downcutting

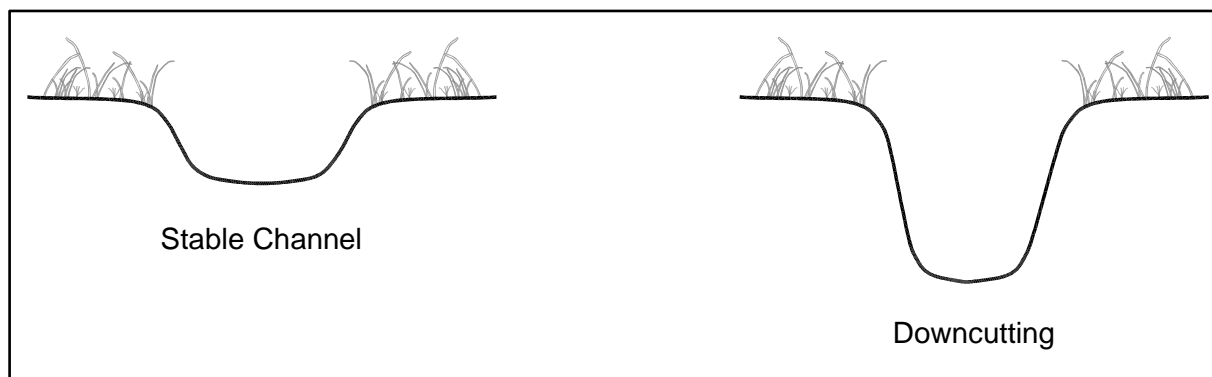

- C. *Loss of Riparian Tree Canopy* – As stream banks are gradually undercut and slump into the channel, the trees that had protected the banks are exposed at the roots. This leaves them more likely to be uprooted during major storms, further weakening bank structure.
- D. *Changes in the Channel Bed Due to Sedimentation* – Due to channel erosion and other sources upstream, sediments are deposited in the stream as sandbars and other features, covering the channel bed, or substrate, with shifting deposits of mud, silt, and sand. Sedimentation is illustrated in Figure 2.1-3.

Figure 2.1-4: Changes in the Channel Bed Due to Sedimentation

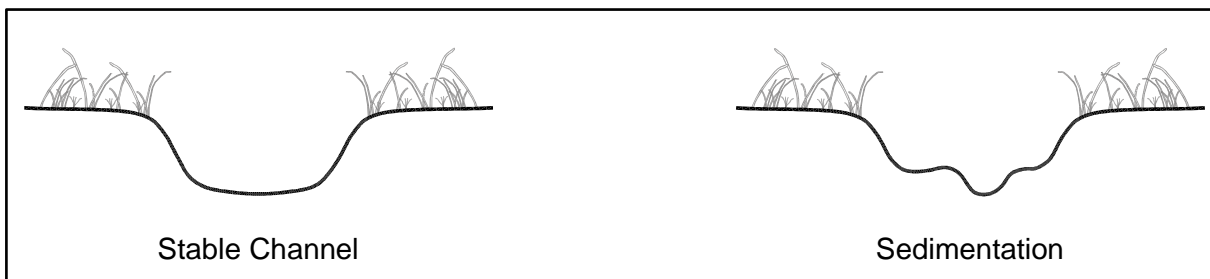

- E. *Increase in the Floodplain Elevation* – To accommodate the higher peak flow rate, a stream’s floodplain elevation typically increases following development in a watershed due to higher peak flows. This problem is compounded by building and filling in floodplain areas, which cause flood heights to rise even further. Property and structures that had not previously been subject to flooding may now be at risk.

2.1.5 Impacts to Aquatic Habitat

Along with changes in stream hydrology and morphology, the habitat value of streams diminishes due to development in a watershed. Impacts on habitat include:

- A. *Degradation of Habitat Structure* – Higher and faster flows due to development can scour channels and wash away entire biological communities. Streambank erosion and the loss of riparian vegetation reduce habitat for many fish species and other aquatic life, while sediment deposits can smother bottom-dwelling organisms and aquatic habitat. Also, changes in bed material and armoring of the stream bottom can lead to lack of spawning habitat.
- B. *Loss of Pool-Riffle Structure* – Streams draining undeveloped watersheds often contain pools of deeper, more slowly flowing water that alternate with “riffles” or shoals of shallower, faster flowing water. These pools and riffles provide valuable habitat for fish and aquatic insects. As a result of the increased flows and sediment loads from urban watersheds, the pools and riffles disappear and are replaced with more uniform, and often shallower, streambeds that provide less varied aquatic habitat.
- C. *Reduced Baseflow* – Reduced baseflow due to increased impervious cover in a watershed and the loss of rainfall infiltration into the soil and water table adversely affect in-stream habitats, especially during periods of drought.
- D. *Increased Stream Temperature* – Runoff from warm impervious areas, storage in impoundments, loss of riparian vegetation and shallow channels can all cause an increase in temperature in urban streams. Increased temperatures can reduce dissolved oxygen levels and disrupt the food chain. Certain aquatic species can only survive within a narrow temperature range. Thermal problems are especially critical for many streams originating at the base of mountains which straddle the borderline between cold-water and warm-water stream conditions.
- E. *Decline in Abundance and Biodiversity* – When there is a reduction in various habitats and habitat quality, both the number and the variety, or diversity, of organisms (wetland plants, fish, macroinvertebrates, etc.) is also reduced. Sensitive fish species and other life forms disappear and are replaced by those organisms that are better adapted to the poorer conditions. The diversity and composition of the benthic, or streambed, community have frequently been used to evaluate the quality of urban streams. Aquatic insects are a useful environmental indicator as they form the base of the stream food chain. Fish and other aquatic organisms are impacted not only by the habitat changes brought on by increased stormwater runoff quantity, but are often also adversely affected by water quality changes due to development and resultant land use activities in a watershed.

2.1.6 Water Quality Impacts

Nonpoint source pollution, which is the primary cause of polluted stormwater runoff and water quality impairment, comes from many diffused or scattered sources—many of which are the result of human activities within a watershed. Development increases the amount of these nonpoint source pollutants. As stormwater runoff moves across the land surface, it picks up and carries away both natural and human-made pollutants, depositing them into Anchorage’s streams, lakes, wetlands, coastal waters and marshes, and underground aquifers. Nonpoint source pollution is the leading source of water quality degradation

in Anchorage. Water quality degradation in urbanizing watersheds starts when development begins. Erosion from construction sites and other disturbed areas contribute large amounts of sediment to streams. As construction and development proceed, impervious surfaces replace the natural land cover and pollutants from human activities begin to accumulate on these surfaces. During storm events, these pollutants are then washed off into the streams. Stormwater can also be polluted from sewer overflows and leaching from septic tanks. There are a number of other causes of nonpoint source pollution in urban areas that are not specifically related to wet weather events including leaking sewer pipes, sanitary sewage spills, and illicit discharge of commercial/industrial wastewater and wash waters to storm drains.

It is important to understand the nature and sources of urban stormwater pollution. Table 2.1-1 “Summary of Urban Stormwater Pollutants” on the following page summarizes the major stormwater pollutants and their effects.

Table 2.1-1: Summary of Urban Stormwater Pollutants

Constituents	Causes/Sources	Effects
Reduced Oxygen in Streams	Decomposition of organic matter	Fish kills Stream life can weaken and die Release of pollutants from deposited sediments
Organic Matter	Leaves Grass clippings Unmanaged pet waste Sanitary sewer leakage Septic tank leaching	Odors Fish kills Dissolved oxygen depletion
Nutrient Enrichment— Nitrate, Nitrite, Ammonia, Organic Nitrogen, Phosphate, Total Phosphorus	Animal wastes Sewer overflows and leaks Septic tank seepage Detergents Wash off of fertilizers and vegetative litter Dry and wet fallout of materials in the atmosphere	Algae blooms Weed growth Eutrophication Recreation/aesthetic loss Ammonia and nitrate toxicity Dissolved oxygen depletion Contaminated groundwater
Microbial Contamination— Total and Fecal Coliforms, Fecal Streptococci Viruses, E.Coli, Enterocci	Sewer overflows Septic tanks Unmanaged pet waste Urban wildlife	Ear/Intestinal infections Recreation/aesthetic loss Increase the cost of treating drinking water
Hydrocarbons— Oils, Greases, Gasoline	Road and parking lot runoff Spills at fueling stations Restaurant grease traps Improper disposal of motor oil	Cancers, tumors, and mutations in fish Drinking water impacts Recreation/aesthetic loss

Other Toxic Materials —Heavy Metals (cadmium, copper, lead, zinc), Pesticides/Herbicides	Vehicles and other machinery Urban surfaces Landfills Hazardous waste sites Atmospheric deposition Industrial and commercial sites	Human & aquatic toxicity Drinking water impacts Bioaccumulation in the food chain
Sedimentation	Erosion from construction sites and exposed soils Street runoff Streambank runoff	Stream turbidity Habitat changes Recreation/aesthetic loss Contaminant transport Filling of lakes, reservoirs, harbors and ditches Clogs storm drains and pipes
Higher Water Temperatures	Runoff from impervious surfaces Fewer trees along streams to shade the water Shallow pond impoundments along a watercourse	Dissolved oxygen depletion Habitat changes
Trash and Debris	Runoff from urban areas	Recreation/aesthetic loss Hazard to wildlife

2.1.7 Stormwater Hotspots

Stormwater hotspots are areas of the urban landscape that often produce higher concentrations of certain pollutants, such as hydrocarbons or heavy metals, than are normally found in urban runoff. These areas merit special management and the use of specific pollution prevention activities and/or structural stormwater controls. Examples of stormwater hotspots include but are not limited to:

- ~ Gas/fueling stations,
- ~ Vehicle maintenance areas,
- ~ Vehicle washing/steam cleaning,
- ~ Auto recycling facilities,
- ~ Outdoor material storage areas,
- ~ Loading and transfer areas,
- ~ Landfills,
- ~ Industrial sites, and

~ Industrial rooftops.

2.1.8 Effects on Lakes, Reservoirs and Estuaries

Stormwater runoff into lakes and reservoirs can have some unique negative effects. A notable impact of urban runoff is the filling in of lakes and embayments with sediment. Another significant water quality impact on lakes related to stormwater runoff is nutrient enrichment. This can result in the undesirable growth of algae and aquatic plants. Lakes do not flush contaminants as quickly as streams and act as sinks for nutrients, metals, and sediments. This means that lakes can take longer to recover if contaminated. Stormwater runoff can also impact estuaries, especially if runoff events occur in pulses, disrupting the natural salinity of an area and providing large loads of sediment, nutrients and oxygen demanding materials. These rapid pulses or influxes of fresh water into the watershed may be two to ten times greater than normal and may lead to a decrease in the number of aquatic organisms living in the unique estuarine environment. Tidal flow patterns can also effectively trap and concentrate runoff pollutants.

2.2 Addressing Stormwater Impacts

The focus of this manual is how to effectively deal with the impacts of urban stormwater runoff through effective and comprehensive stormwater management. Stormwater management involves both the prevention and mitigation of stormwater runoff quantity and quality impacts as described in this section through a variety of methods. This manual addresses ways that designers and developers can effectively manage stormwater to minimize impacts of new development and redevelopment as well as to prevent and mitigate problems associated with stormwater runoff. This is accomplished by:

Developing land in a way that minimizes its impact on a watershed, and reduces both the amount of runoff and pollutants generated;

Controlling stormwater runoff peaks, volumes, and velocities to prevent both downstream flooding and streambank channel erosion;

Treating post-construction stormwater runoff before it is discharged to a waterway;

Implementing pollution prevention practices to prevent stormwater from becoming contaminated in the first place;

Using various techniques to maintain groundwater recharge; and

Using the most current and effective erosion and sedimentation control practices during the construction phase of development (see the ASM Volume Two - Construction Practices for additional information).

Intentionally Left Blank

3.0 STORMWATER MANAGEMENT REQUIREMENTS

3.1 Overview

This section presents a comprehensive set of the stormwater management requirements for development activities within the MOA. The overall goal is to provide an integrated approach to address both the water quality and quantity impacts associated with stormwater runoff due to urban development. The goal of the stormwater management requirements is to reduce the impact of post-construction stormwater runoff on the watershed. The requirements apply to areas of new development and areas of significant redevelopment. Reduction of impacts can be achieved by:

- A. Maximizing the use of better site design and nonstructural methods to reduce pollutants and the generation of runoff, and
- B. Managing and treating stormwater runoff through the use of structural stormwater controls.

3.2 Stormwater Plan Review and Approval

Per the MOA's APDES permit, the MOA is the sole entity responsible for stormwater plan review of both Municipal projects and privately owned projects within the MOA. (DOT&PF linear projects are reviewed by ADOT&PF.) Stormwater plan review will include review of project plans to ensure consistency with the requirements of this section prior to commencing construction activities. Project plans shall not be submitted to ADEC for stormwater review.

Required submittal information for construction-related stormwater controls is addressed in the Anchorage Stormwater Manual Volume 2.

3.3 Stormwater Management Requirements

This section of the ASM identifies the stormwater management requirements for development and redevelopment in Anchorage. The requirements that are applicable to each project vary depending on project classification. Projects categories are defined below. When identifying the appropriate category for a project, all phases of the project shall be considered. For projects that are part of a larger plan of development, project category must consider the entire collective project.

3.3.1 Project Classifications

3.3.1.1 Exempt Projects

Exempt projects are one of the specialized types of projects listed below. Note that projects are not exempt if the item listed below is only a small component of the project. It must be the primary purpose.

- A. Culvert repair or replacement
- B. Projects intended to relieve localized groundwater impacts and do not alter surface flows
- C. Routine maintenance or repair projects, such as pothole repairs
- D. Pavement resurfacing. This applies only to pavement rehabilitation and “mill and pave” projects. Subgrade work, grading, drainage improvements, activities that change drainage patterns, or other related site modifications do not fall under this category.
- E. Chip-sealing and related roadway maintenance projects
- F. Trenching and resurfacing associated with utility work
- G. Redevelopment projects that only install sidewalks, bike lanes, or pedestrian ramps on an existing road and do not change sheet flow condition to a concentrated flow condition
- H. Emergency repair projects

3.3.1.2 Small Projects

Small projects are projects with less than 10,000 square feet of land disturbance area or a fill and grade permit for a residential single family home or duplex involving only one lot with less than 5,000 CY of fill material.

3.3.1.3 Medium Projects

Medium projects are projects that disturb 10,000 or more square feet of land, do not fall under the description of a Small Project, and meet one of the following criteria:

- A. The entire project area does not exceed 0.75 acres.
- B. The fractions of impervious, lawn or other landscaping, and naturally vegetated landcover types present at pre-development of the project will not change by more than 5% as a result of the proposed development.

3.3.1.4 Large Projects.

Large projects are projects that disturb 10,000 or more square feet of land and do not meet the requirements for a Medium Project.

3.3.2 Stormwater Management Requirements

This section presents the stormwater management requirements for new development or redevelopment sites. A summary of these requirements and a list of applicability for each project type are provided in Table 3.2-1, and a description of each requirement is provided below.

Table 3.2-1: Summary of Stormwater Standards and Requirements

Project Classifications	Stormwater Management Requirements									
	Water Quality Treatment	Extended Detention	Conveyance	Detention and Peak Flow Control			Operation and Maintenance Plan	Stormwater Management Report	Complete Drainage Certification Form	Wetland Compliance
				Peak Flow Control	Project Flood Bypass	D/S Impact Analysis				
Section Reference	Section 3.3.2.1	Section 3.3.2.2	Section 3.3.2.3	Section 3.3.2.4 and 3.3.2.5			Section 3.3.2.7	Section 3.3.2.8	Appendix A	Section 3.3.2.6
Notes	<i>Using Relevant Tools from Section 6</i>	<i>Only required and/or allowed in select cases.</i>	<i>10-year 24-hour event</i>	<i>Two options are available to meet these three requirements. Designer can select preferred option.</i>						
Exempt Projects										✓
Small Projects			✓						✓ (Part A)	✓
Medium Projects	✓	✓	✓				✓		✓ (All)	✓
Large Projects	✓	✓	✓	✓	✓	✓	✓	✓		✓

3.3.2.1 Requirement 1 – Water Quality Treatment

Stormwater management systems must be designed to provide water quality treatment through the use of Green Infrastructure. Treatment must be provided for runoff generated from the first 0.52 inches of rainfall from a 24-hour rainfall event preceded by 48 hours of no precipitation. Allowable methods for calculating this volume of runoff are presented in Section 4. Allowable Green Infrastructure techniques are presented in Section 6 and include methods such as retention, infiltration, bioretention, evaporation, rainfall harvesting, and/or any combination of these techniques. The types of stormwater management structures and facilities that are appropriate for meeting this requirement will vary depending on site conditions and constraints. See Section 6 for descriptions, applicability, and design criteria of various structural stormwater controls that incorporate these techniques.

A list of techniques presented in this manual that meet the requirement for treatment through Green Infrastructure is provided below. The designer must select a treatment tool that is applicable to the site for which it is used.

- A. Bioretention – Section 6.6.1
- B. Soakaway Pits – Section 6.6.2
- C. Infiltration Basins – Section 6.6.3
- D. Infiltration Trenches – Section 6.6.4
- E. Vegetated Swales – Section 6.6.5
- F. Pervious Pavement – Section 6.6.6
- G. Chamber Systems – Section 6.6.7
- H. Wet Ponds – Section 6.6.8
- I. Dry Ponds (if they are enhanced) – Section 6.6.9
- J. Filter Strips – Section 6.6.11
- K. Constructed Wetlands – Section 6.6.12
- L. Landscaped Depressions – Section 6.6.13
- M. Canopy Cover/Vegetation Retention – Section 6.6.14
- N. Sedimentation Basins – Section 6.6.16

Combinations of these tools are also acceptable.

20% Area Allowance

Most of the Green Infrastructure stormwater controls presented in Section 6 are designed based on a calculated volume of runoff resulting from the water quality rainfall event described above. (Methodology for determining this volume is presented in Section 4.) The treatment volume must reflect the projected volume of runoff from the entire site. However, in cases where treatment is more easily achieved in one part of a project than another, treatment of additional volume in the preferred location may be substituted for no treatment in the more difficult location, provided the difficult location does not exceed 20 percent of the site's impervious surface or 20 percent of the total site. The total treatment volume must be based on the entire site, and no more than 20 percent of the site's impervious surfaces or 20 percent of the total site may go untreated through substitution elsewhere.

For example, in some situations, a roadway project may experience difficulty treating runoff from portions of a horizontal curve that is super-elevated to shed water in a different direction than

the rest of the roadway. In this situation, the runoff from the curve may be untreated, provided that (1) the equivalent volume of runoff from the curve is treated elsewhere in the project and (2) the untreated area does not exceed 20 percent of the project's impervious surface and (3) the untreated area does not exceed 20 percent of the total project site.

The allowance is only applicable when Green Infrastructure is used to meet treatment requirements. In cases where traditional treatment is provided (see discussion below), substitution is not allowed.

Green Infrastructure Infeasibility and Traditional Treatment

The Green Infrastructure techniques presented in this manual were developed and modified to be applicable for a wide range of site constraints commonly present in Anchorage. Section 6 presents modifications to Green Infrastructure facilities that account for constraints such as poorly infiltrating soils, high groundwater table, on-site space constraints, shallow bedrock, etc. The methods and adaptations discussed in Section 6 are anticipated to provide a Green Infrastructure pathway for most projects.

However, in some cases, stormwater treatment through green infrastructure may be determined to be infeasible. Forms to request an infeasibility concurrence from the MOA are provided in Appendix L. Separate forms are provided for roadway projects and private development projects. Please select the form that is applicable to your project type.

Application of Green Infrastructure is typically determined to be infeasible in cases where *multiple* constraining elements prevent its use or severely restrict its overall function and benefit. For example, if a project has both severe space constraints (such limited ROW space or unique site features) and a very high ground water table, green infrastructure may not be feasible. The lack of surface space would prevent the use of bioretention or stormwater ponds, and the high groundwater table would prevent the use of subsurface facilities like soakaway pits or chamber systems. It should be noted that the presence of multiple constraining elements does not necessarily indicate infeasibility. For example, if a site has very slow draining soils and a high groundwater table, a bioretention area(s) with a modified section and a sub-drain may still be a reasonable alternative. Before requesting a waiver of the green infrastructure requirements based on infeasibility, the designer should consider the practical application of the stormwater controls listed above and described in Section 6. The designer will be required to justify the request. Reference the forms in Appendix L for additional information.

For cases where green infrastructure is determined to be infeasible, water quality treatment may be achieved through traditional gray infrastructure such as an oil and grit separator. Design criteria for oil and grit separators are also presented in Section 6. Additional extended detention requirements may also apply.

Roadway Projects with Narrow Rights-of-Way

Projects that construct, re-construct, modify, or widen a roadway corridor that is within a continuous average right-of-way width of 60 feet or less may choose to provide stormwater treatment through either green infrastructure or traditional treatment. For roadway projects with right-of-ways wider than 60 feet, Green Infrastructure feasibility should be considered. Reference the roadway project form in Appendix L for additional information.

Discharge to Wetlands

In some cases, directing project runoff to existing wetland areas may be a viable stormwater treatment mechanism. The feasibility of this option will be considered by WMS on a case-by-case basis. Factors such as wetland type, wetland hydrologic function, wetland size, surrounding area characteristics, surrounding area drainage, quality of proposed discharge, and quantity of proposed discharge will be considered when making this determination.

3.3.2.2 Requirement 2 – Extended Detention (Channel Protection)

Extended detention is intended to protect streams and channels from erosion due to an increase in post-development flow. Extended detention requires that applicable projects detain post-development project runoff in excess of the pre-development project runoff for the 1-year, 24-hour storm for a period of 6 hours.

This requirement applies to site projects that are not using Green Infrastructure treatment to comply with the water quality treatment requirement. Green Infrastructure will generally also provide extended detention through the facility treatment process.

Projects are exempted from this requirement when:

- A. Green Infrastructure is used to meet water quality treatment requirements (See Stormwater Management Requirement No. 1);
- B. The project stormwater flows discharge directly to tidewater; or
- C. The project stormwater flows discharge directly to a 4th order or larger stream.

3.3.2.3 Requirement 3 – Conveyance

Conveyance design is required for small and large projects. Conveyance design shall be based on the sum of all contributing flows. This includes both project area flows and upstream and lateral inflows. Size conveyances to pass peak runoff flows for the 24-hour duration design storm with a return period based on water course type as listed below:

- A. Drainageway: 10-year
- B. Stream: 100-year

If drainage is directed offsite, it must be directed into an established natural water course or an existing storm drainage facility. In cases where municipal drainage systems are not available or if the designer elects to keep project runoff onsite, the project must keep and manage onsite runoff generated from the required conveyance design storms. Other stormwater management requirements still apply. Additional requirements for drainage and conveyance in the MOA are presented in Section 1.5, Municipal Stormwater Policies.

3.3.2.4 Requirement 4 – Detention and Peak Flow Control

Downstream flood protection through control of peak flows is required. The MOA allows two options for detention and peak flow control.

Option 1

1. **Peak Flow Control:** Maintain the post-development project runoff peak flow from the 10-year, 24-hour storm to less than or equal to 1.05 times pre-development runoff peak flow at all project discharge points;
2. **Project Flood Bypass.** Design bypass diversions for the post-development, 100-year, 24-hour storm runoff event or show an unobstructed, overland flow path safely bypassing project structures and/or overtopping project conveyance routes without impact to property affected by bypass route.
3. **Downstream Impacts. (Follow Process in Section 3.2.2.5)**

Magnitude and Timing. Maintain the post-development peak flow from the 10-year, 24-hour storm to less than or equal to 1.05 times the pre-development runoff peak flows at all downstream critical points (A downstream impact analysis is required. See Section 3.2.2.5 below.)

- Where downstream overtopping occurs pre- or post-development, control the peak flow to achieve post-development overtopping duration less than 1.05 times the pre-development overtopping duration. OR
- Improve downstream conveyance to yield no adverse impact.

Flood Capacity: Demonstrate that the post-development peak flow from the 100-year, 24-hour storm can safely bypass structures and/or overtop conveyance routes without impact to property downstream. (See Section 3.2.2.5 below for details) OR

Control the post-development peak flow from the 100-year, 24-hour storm event to less than or equal to 1.05 times the pre-development peak flow.

Option 2

1. **Peak Flow Control**
 - a. Maintain the post-development project runoff peak flow from the 10-year, 24-hour storm **to less than or equal to the** pre-development runoff peak flow at all project discharge points. AND
 - b. Maintain the post-development project runoff peak flow from the 100-year, 24-hour storm to less than or equal to 1.05 times the pre-development runoff peak flows.
2. **Project Flood Bypass.** Design bypass diversions for the post-development, 100-year, 24-hour storm runoff event or show an unobstructed, overland flow path safely bypassing project structures and / or overtopping project conveyance routes without impact to property affected by bypass route.
3. **Downstream Impacts.** A downstream impact analysis (as described in Section 3.2.2.5) is not required for this option if the project is located within the Anchorage Roads and Drainage Service Area (ARDSA). Projects outside of ARDSA must meet the downstream impact analysis requirements in item 3 under Option 1.

3.3.2.5 Requirement 5 – Downstream Impact Analysis

A downstream impact analysis is required for cases described in Section 3.3.2.4 above to demonstrate that a project does not cause adverse impacts to downstream waterway. See Requirement 4 above to determine if a downstream impact analysis is required.

A downstream impact is a hydrologic analysis of the drainage system that is receiving project discharge. The downstream impact analysis must demonstrate that the thresholds for peak flow control, described in Section 3.2.2.4 above are not exceeded. The downstream impact analysis looks at changes in peak flow magnitude and overtopping duration at critical points downstream of the project. Critical points are defined as locations where increased flow from the project is likely to cause an observable adverse impact. Examples include:

- A. Drainageway confluences
- B. Locations known to be hydraulically insufficient prior to the new project construction
- C. Locations that the local maintenance authority reports to be problematic
- D. Locations where flow momentum changes, such as a sharp turn or vertical drop
- E. Locations of channel bank erosion or backwater

Analysis Requirements

Completion of a downstream impact analysis for most systems requires the use of hydrologic modeling software capable of routing hydrographs through conveyance systems. For the Anchorage Bowl, SWMM is commonly used. For the Anchorage hillside, SWMM may be used for routing, but hydrograph generation may need to be completed using a separate analysis or software, as SWMM's hydrograph generation method is not always applicable to less developed areas. See Sections 4.5 through 4.8 for more information.

Analysis Ending Point

The downstream analysis shall be completed to the location where the designer determines that project flows will no longer have a significant effect on the drainageway. In some cases, this point may be the project discharge point. In other cases, this point may be much further downstream. The location of this point is project-specific and dependent on a number of criteria. Determining an appropriate ending point for the analysis requires designer judgment. The following items/considerations may help aid designers in selecting this point:

- A. The total area of the basin contributing directly to the point in question. If the drainage basin contributing to the discharge point or potential ending point is significantly larger than the project area, the project's flow may have less of an impact.
- B. The magnitude of the peak flows from the project area compared to the peak flow of the receiving system. If the project area is contributing a very small amount of flow compared to the overall system flow at the point in question, the impact of the project at that point is typically less significant. (See analysis step 2 for more guidance.)

- C. The capacity of the downstream receiving system. If the receiving system is at or beyond capacity at the point in question, even a small amount of flow increase may be problematic.

Analysis Steps

Typical steps for completing a downstream impact analysis are presented below.

1. Determine if your project will be changing existing drainage patterns. If no, proceed to Step 2. If yes, skip to Step 3.
2. Look at the site's receiving system. This may be a storm drain pipe, an open channel, a creek, etc. Delineate the drainage basin upstream of the proposed connection point. Compare the size of the upstream basin to the size of the project site. This will help determine how far downstream your analysis needs to go. If the upstream basin *specifically contributing to the proposed connection point* in question is significantly larger than your project site (your site area is less than 5% of the upstream basin area), no further analysis is needed. If not, proceed to step 3.
3. Look at the downstream receiving system and select a location downstream where project flows are less likely to be impacting the overall system performance. (See discussion above.) Delineate the drainage basin to this point. Describe the conveyance system and list or show the critical points between the project discharge point and the analysis ending point.
4. Develop the 10-year, 24-hour runoff hydrograph for *current* conditions (before your proposed project is constructed) and route this hydrograph through the system to the selected ending point. Use appropriate subbasin delineation and routing techniques based on the basin characteristics and the locations and capacity of conveyance infrastructure. Look at peak flows at downstream critical points.
5. Develop the 10-year, 24-hour runoff hydrograph for *proposed* conditions (after your proposed project is constructed) and route this hydrograph through the system to the selected ending point. Use appropriate subbasin delineation and routing techniques based on the basin characteristics and the locations and capacity of conveyance infrastructure. This should match your existing conditions analysis. Look at peak flows at downstream critical points.
6. Compare the current and proposed conditions peak flows at downstream critical points. Ensure that the proposed conditions peak flows are less than 1.05 times the existing peak flows at downstream critical points. If they are larger, modify runoff rates from your site by changing the runoff flow path, incorporating detention, etc.
7. Examine the capacity of the receiving system at downstream critical points. Ensure that there is adequate capacity for the proposed conditions peak flow.
 - a. If the peak flow from *current* conditions exceeds the capacity of the system, ensure that the proposed conditions peak flow increases the overtopping time duration by less than 1.05 times the current conditions overtopping duration **OR**

improve the receiving system to ensure no adverse impacts.

8. Develop the 100-year, 24-hour runoff hydrograph for *current* conditions (before your proposed project is constructed) and route this hydrograph through the system to the selected ending point. Use appropriate subbasin delineation and routing techniques based on the basin characteristics and the locations and capacity of conveyance infrastructure. Look at peak flows at downstream critical points.
9. Develop the 100-year, 24-hour runoff hydrograph for *proposed* conditions (after your proposed project is constructed) and route this hydrograph through the system to the selected ending point. Use appropriate subbasin delineation and routing techniques based on the basin characteristics and the locations and capacity of conveyance infrastructure. This should match your existing conditions analysis. Look at peak flows at downstream critical points.
10. Compare the current and proposed conditions peak flows at downstream critical points.
 - a. Ensure that the proposed conditions peak flows are less than 1.05 times the existing peak flows at downstream critical points. Modify the proposed site design as need to achieve this. **OR**
 - b. Demonstrate that the proposed conditions peak flows can safely bypass structures and/or overtop conveyance routes without causing adverse impacts to properties. Complete this analysis to the selected ending point.

3.3.2.6 Requirement 6 – Wetland Compliance

Compliance with wetland regulations is required when jurisdictional wetlands disturbances occur that are subject to a U.S. Army Corps of Engineers Section 404 permit. Compliance requirements vary based on site-specific conditions.

The requirement is intended to guide the designer in developing controls that are adequately sized to satisfy conditions in a U.S. Army Corps Section 404 permit, if issued for the project. For additional information related to wetland compliance and mitigation within the MOA, please reference the most current version of the Anchorage Wetlands Management Plan. This document is available from the MOA Project Management and Engineering (PM&E) website.

3.3.2.7 Requirement 7 – Operation and Maintenance Plan

The stormwater management system, including all structural stormwater controls and conveyances, shall have an operation and maintenance plan to ensure that the system continues to function as designed.

All projects subject to these criteria shall include a comprehensive operation and maintenance plan for the on-site stormwater management system(s). This is to include all of the stormwater management system components, including drainage facilities, structural stormwater controls, and conveyance systems. To ensure that stormwater management systems function as they were designed and constructed, the operation and maintenance plan must provide: (1) a clear assignment of stormwater inspection and maintenance responsibilities; (2) the routine and non-

routine maintenance tasks to be undertaken; (3) a schedule for inspection and maintenance; and (4) copies of any relevant drainage agreements/easements.

Note: Projects with disturbance of 10,000 square feet and above and a commercial end use that will not be maintained by the MOA or ADOT&PF shall be required to execute a Stormwater Facility Operation and Maintenance Agreement prior to issuance of a building permit. A sample agreement is provided for reference in Appendix B. A sample annual self-inspection form is also provided in Appendix B. They are not required part of the Stormwater Report submittal described in Section 3.3.2.8.

3.3.2.8 Requirement 8 – Stormwater Management Report

All applicable projects shall include a stormwater management report for MOA review that addresses compliance with Stormwater Management Requirements 1 through 7. (See Table 3.2-1 for applicability.)

The stormwater report is to provide details, including narrative, technical information, and analysis indicating how the proposed development meets Requirements 1 through 6. Details regarding preparation of this report, required notifications, and report components are provided in Section 3.4.

Where required per Table 3.2-1, a Stormwater Management Report shall be submitted as part of the application for a Commercial Building Permit, Commercial Fill and Grade Permit, Land Use Permit, Subdivision Agreement, or Improvement to Public Places Agreement. No Building Permit, Notice to Proceed for a Subdivision Agreement, or Improvement to Public Places Agreement will be issued until a final Stormwater Management Report has been submitted and approved.

Submittal of both a preliminary and final Stormwater Management Report is necessary for projects that require preliminary MOA review, such as plat applications. At the discretion of Municipal Engineer, preliminary reports may also be required for projects where downstream systems are sensitive. Submit the preliminary Stormwater Management Report to Private Development within Development Services.

3.4 Reporting Requirements

3.4.1 Drainage Project Notification

All projects subject to these criteria are required to submit mapping of watercourses within the project area (streams and major drainageways) with the submittal of the stormwater management report. The mapping must be reviewed and approved by Watershed Management Services (WMS). Watercourse mapping must completely and accurately identify all waters of the United States and major drainageways in the project area for both pre- and post-development conditions. For streams mapping, applicants may either prepare mapping independently and submit it to the MOA for review or request mapping by WMS. When requesting mapping from the WMS, a Drainage Project Notification form, presented in Appendix A, must be submitted and permission for access to the property must be provided.

Where available from earlier platting or subdivision activities, watercourse mapping previously approved by WMS or the MOA Planning Department's wetlands staff will be accepted as approved as long as it is

accompanied by a certification from the applicant that the provided watercourse mapping accurately represents current conditions.

In all stream mapping cases, MOA digital streams mapping shall be used as a minimum representation of the presence and location of streams, and/or WMS will perform onsite inspections and prepare digital location maps at a base-map accuracy level. Details on WMS mapping standards and accuracy levels are available in the Municipal Stream Classification: Anchorage, Alaska (MOA, 2004) and the MOA Stream Mapping Standards (MOA, November 2005).

3.4.2 Stormwater Management Report Components

As described in Stormwater Management Requirement 8, a Stormwater Management Report is required for applicable projects within the MOA. A description of each part of the required Stormwater Management Report is provided below.

Stormwater management reports must be certified by appropriate licensed professionals as described below:

- A. Stormwater management reports for sites up to two (2) acres, to the point of off-site discharge, must be sealed and signed by either a State of Alaska licensed professional landscape architect or a State of Alaska licensed professional civil or environmental engineer.
- B. Stormwater management reports for sites greater than two (2) acres or projects involving public drainage systems, streams, or surface or piped drainage within road rights-of-way must be sealed and signed by a State of Alaska licensed professional civil or environmental engineer.

Part 1 - Cover Page:

The cover page should include the project title, project owner, owner contact information, the name, company, and professional seal of the engineer submitting the report, and the date of submittal.

Part 2 - Project Description:

Provide a thorough description of the project. Include the project's purpose, the project owner, and a description of proposed facilities.

Part 3 - Drainage basin descriptions:

Provide a description and graphic of the drainage basin describing/illustrating the following:

- A. Size of basin
- B. Existing conditions land cover and existing conditions land use
 - ~ The Report shall tabulate the existing conditions land cover types as percentages of undisturbed naturally vegetated areas, directly connected impervious areas, indirectly connected impervious areas, and contributing grassed or other landscaped areas.
- C. Proposed conditions land cover and proposed conditions land use
 - ~ The Report shall tabulate the proposed fully developed land cover types as percentages of undisturbed naturally vegetated areas, directly connected impervious areas, indirectly connected impervious areas, and contributing grassed or other landscaped areas.

D. Map of the basin including drainageway mapping

Part 4 - Existing Conditions Site Plan:

Provide a written description of the existing conditions and drainage, and provide an existing conditions site plan (a graphic is required) showing the location and connectivity of all existing drainage features, including both constructed and natural features. The plan shall identify all existing drainage features including locations where drainage currently enters drainage systems or natural drainageways and shall include arrows showing existing flow directions.

Part 5 - Proposed Conditions Site Plan/Grading and Drainage Plan:

The Report shall include written description of the proposed conditions and drainage, and a site plan and a project grading and drainage plan meeting the applicable requirements below. The site plan and project grading and drainage plan must be illustrated in a graphic.

- A. Show the location and connectivity of all proposed drainage features, including both constructed and natural features within 50 feet of the project boundaries and in adjacent ROW. This includes but is not limited to, storm drains, inlets, manholes, culverts, ditches, structural stormwater controls, outfalls, riprap areas, energy dissipaters, and swales.
- B. Identify where drainage will enter existing drainage systems or natural drainageways.
- C. Include arrows showing proposed flow directions.
- D. Identify the ultimate receiving water(s) for the new drainage.
- E. Clearly mark points where site drainage is proposed to exit the site or development.
- F. For sites requiring on-site wastewater disposal, show proposed septic systems, areas designated for future septic systems, expansions, locations of septic systems on adjacent properties, and all water wells within 200 feet of the project's property boundaries.
- G. Show the location of existing septic drainfields.
- H. Show the location of all drinking water wells on the site. Identify the location of off-site drinking water wells within 200 feet of the site.
- I. Include the ordinary high water and 100-year surface water elevations for water bodies within the project boundary or affected by project discharges.
- J. Show existing and proposed property and zoning boundaries.
- K. Show all easements, including platted and document easements, development and stream setbacks, flood hazard areas, wetland boundaries, and other waters of the United States.
- L. Present existing and proposed topography with a contour interval of two feet or less. The contour interval may be four feet in areas with a slope greater than 10 percent. Topographic information shall extend a minimum of 50 feet beyond the plat or project boundary and shall include existing and proposed spot elevations at each property corner. The existing grade of adjacent utility easements shall also be included. Proposed topographic information shall be based on final placement of four to six inches of topsoil when applicable.

- M. Show proposed grade breaks and grade break elevations.
- N. Show relevant cross sections to demonstrate proposed cuts and fills.
- O. Show elevations and dimensions of proposed roads, sidewalks, pathways, parking lots, and other impervious surfaces.
- P. Include typical building footprints on each lot or tract with finish floor elevations.
- Q. Include proposed finish grade including all utility easements.
- R. Show drainage patterns at property lines.
- S. Show drainage patterns and ground elevations between buildings.
- T. Show areas of vegetation to be retained.
- U. Show required landscape areas.

Part 6 – Stormwater Controls Construction Considerations Plan

For all reports that include structural stormwater controls, the report shall include a plan that outlines appropriate construction considerations relating to of stormwater controls. (Construction considerations for each type of control are provided in Section 6.) The designer should carefully consider construction methods that may impact the performance and longevity of the stormwater controls. **The construction considerations plan must be included as part of the project plan set or specifications.**

Part 7 - Soils Information:

The Report shall include soils information including test hole locations, soil boring analyses, soil erodibility, maximum allowable slopes, infiltration or percolation rates, water table elevations, and potential dewatering requirements.

Groundwater levels fluctuate from season to season and from year to year. The magnitude of the fluctuation depends on many factors including precipitation and snow-melt rates in current and preceding seasons. Groundwater in the Anchorage area typically has two annual “peaks”, generally occurring around mid-May and mid-October. In some locations, groundwater may peak at other times. When possible, groundwater levels for design of stormwater controls should be obtained during a seasonally high peak. In instances where this is not feasible, the designer should demonstrate that the design considers the potential for a higher groundwater table, or provide evidence that the levels used for design are considered seasonally high for the area. The acceptability of groundwater readings not obtained during a peak time will depend on the design and function of the facility; the facility sensitivity to groundwater; the potential for drinking water contamination; how close the facility design is to the minimum groundwater separation distance; and the facility’s overflow and/or bypass design.

Part 8 - Compliance with Stormwater Management Requirements:

The Report shall include descriptions and supporting documentations to show compliance with Stormwater Management Requirements 1 through 8. Include a heading for each requirement. If specific

requirements are not applicable to your project as defined in this manual, include the heading followed by a discussion of why your project is exempt.

Part 9- Hydrologic and Hydraulic Computations:

- A. The Report shall include computations using approved methods for estimating runoff and sizing all drainage facilities including conventional conveyance facilities (all facilities in Section 5), structural stormwater controls (all facilities in Section 6), and any other facility not expressly described in this manual that is intended to treat, convey, capture, store, or control stormwater.
- B. Computations shall include all calculations or analyses used to design or size the facilities. This includes but is not limited to peak flow computations, capacity determinations, inflow and outflow hydrographs, storage volume computations, scour and erosion analyses, and other relevant parameters discussed in this manual.
- C. Computations may be neatly compiled hand calculations, graphs, computation tables, and computer modeling input/output.
- D. If computer models were used as part of the design, the designer is required to submit the following items:
 - 1) A hard-copy print of the model input and output.
 - 2) An electronic copy of the model and all supporting files (if requested by the MOA).
- E. Calculations shall include a list of assumptions the designer selected during the design.
- F. Construction plans submitted for a flood hazard permit in a special flood hazard area shall follow applicable FEMA-related requirements.

Part 10 - Operation and Maintenance Plan:

In accordance with Stormwater Management Requirement 7, include a complete Operation and Maintenance plan for the drainage components of the facility.

Part 11 - Miscellaneous:

Include the following miscellaneous components if they are applicable to your project. Also include other information that you feel is relevant to the reviewer.

- A. A description of post-construction revegetation plans, if applicable.
- B. Information on impaired water bodies or water bodies with approved total maximum daily loads (TMDLs) adjacent to or downstream from the project site.
- C. On-site septic systems located on properties adjacent to proposed drainage structures, stormwater control facilities, or surface conveyances to which drainage is directed or discharged.
- D. List any future MOA, DOT&PF, and Anchorage Water and Wastewater Utility (AWWU) projects that may affect the proposed drainage plan.

Intentionally Left Blank

4.0 ESTIMATING STORMWATER RUNOFF

4.1 Introduction to Hydrologic Methods

Hydrology deals with estimating flow peaks, volumes, and time distributions of stormwater runoff. The analysis of these parameters is fundamental to the design of stormwater management facilities, such as storm drainage systems and structural stormwater controls. In the hydrologic analysis of a development site, there are a number of variable factors that affect the nature of stormwater runoff from the site. Some of the factors that need to be considered include:

- ~ Rainfall amount and storm distribution;
- ~ Drainage area size, shape and orientation;
- ~ Ground cover and soil type;
- ~ Slopes of terrain and stream channel(s);
- ~ Antecedent moisture condition;
- ~ Storage potential (floodplains, ponds, wetlands, reservoirs, channels, etc.);
- ~ Watershed development potential; and
- ~ Characteristics of the local drainage system.

There are a number of hydrologic methods that can be used to estimate runoff characteristics for a site or drainage subwatershed; however, the methods presented in subsequent sections of this section have been selected to support hydrologic site analysis for the MOA. These methods were selected based on applicability to local conditions, analytical complexity, and the availability of equations, nomographs, and computer programs to support the methods.

It is important to note that the complexity of a drainage basin's hydrology increases with basin size, variations in land cover within the basin, variation in slopes within the basin, and complexity of hydraulic routing channels. Some of the common, simple methods presented in this manual that are applicable to small, homogenous basins may not be applicable to larger, more diverse basins. It is the responsibility of the designer to select a hydrologic method that is applicable to the basin being considered.

For general use, a list of existing drainage studies that have been completed for the MOA is provided in Appendix C.

4.2 Design Storms and Rainfall Estimation

Characteristics of base design storms for use in MOA rainfall runoff analysis and design applications are summarized below.

4.2.1 Intensity-Duration-Frequency Curves

The Anchorage intensity-duration-frequency (IDF) curves are based on data collected at Ted Stevens Anchorage International Airport (TSAIA) between 1962 and 2002 (USKH, 2006) and on data obtained from NOAA Atlas 14 for Girdwood. The IDF curves are presented in Figures 4.2-1 and 4.2-2. These IDF curves are only to be used:

- A. With the Rational Method as allowed in this manual, or,
- B. To obtain the 24-hour storm depth for different frequency events.

Figure 4.2-1: Intensity-Duration-Frequency Relationships for Anchorage and Eagle River

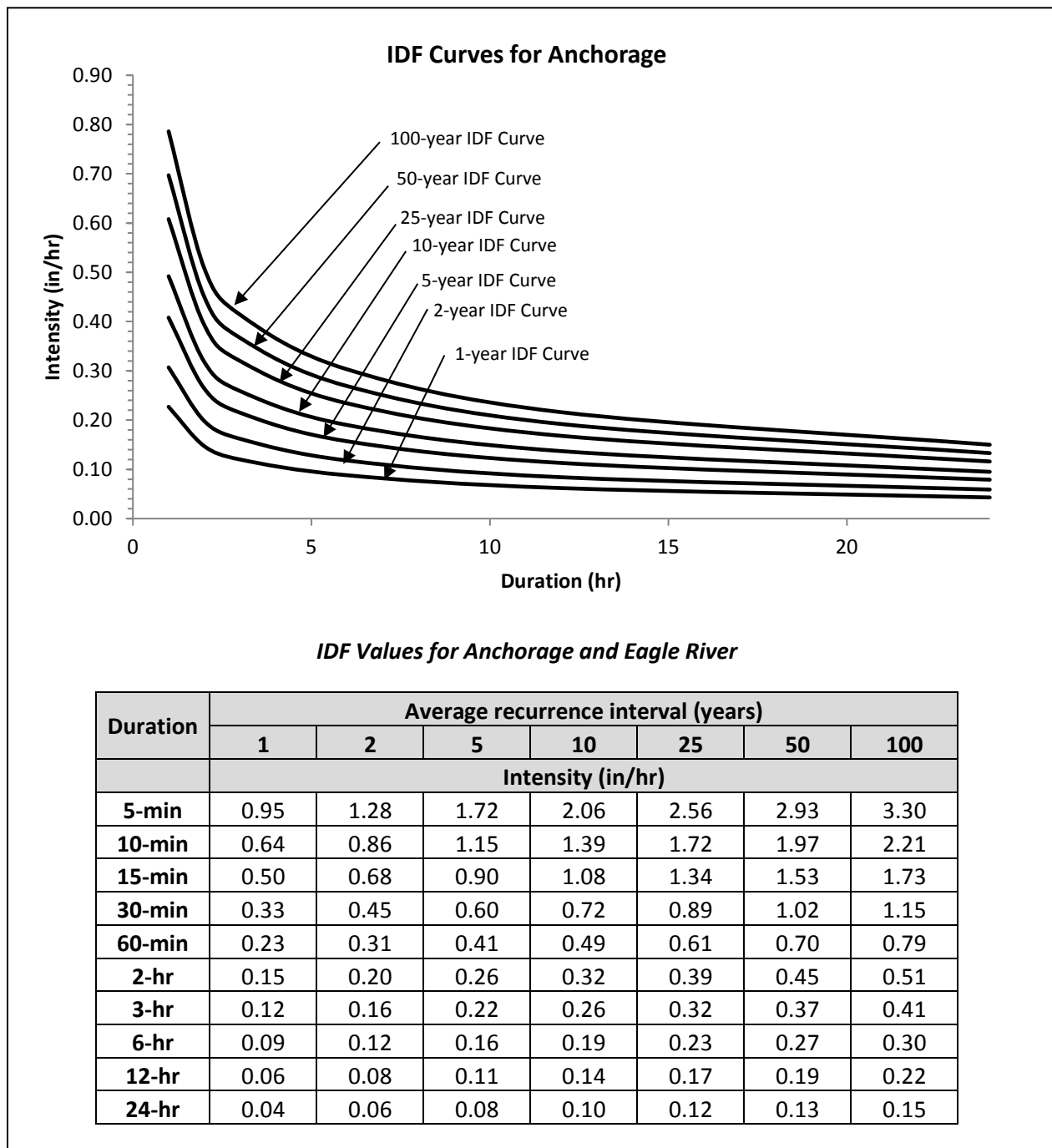

Source: NOAA Atlas 14 Volume 7 Precipitation Frequency Data Server, Station 50-0280

Figure 4.2-2: Intensity-Duration-Frequency Relationships for Girdwood

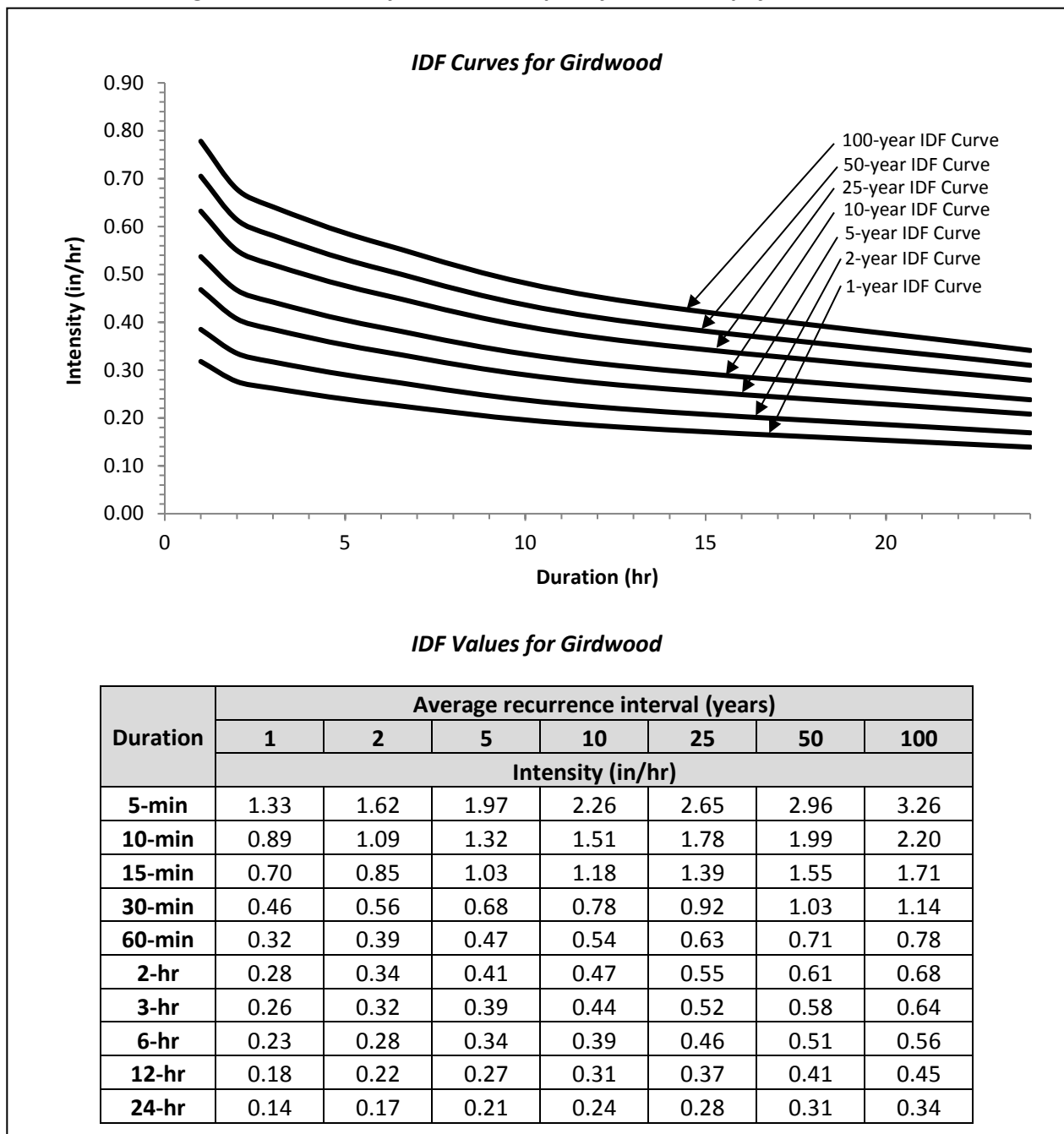

Source: NOAA Atlas 14 Volume 7 Precipitation Frequency Data Server, Station 50-0243

4.2.2 Design Storm Depth – Base and Adjusted

Appropriate design storm selection varies depending on the type of analysis being performed. Refer to Table 4.2-1 for required design storm depths for various applications. These depths represent the base depth for storms with the specified duration and frequency. The depths in this table are based on the IDF curves presented in Figures 4.2-1 and 4.2-2.

The mountainous and peninsular geography of Anchorage along the path of the North Pacific jet stream results in pronounced and generally predictable differences in precipitation amounts along the mountain fronts (an orographic effect). MOA drainage criteria require application of an orographic factor to adjust the “base” depth for these effects, depending on the location of the project. Once the base depth of a design storm has been multiplied by the appropriate orographic factor, it is referred to as an “adjusted” design storm.

Maps indicating the appropriate orographic factor to be used for most locations within the MOA are provided in Figures 4.2-3 and 4.2-4.

For the Girdwood area, orographic factors are built into NOAA’s interactive Precipitation Frequency Data Server website. Select Alaska, locate the project area on a the map provided, double click on the project location, and the appropriate design storms for that location will be provided on below the map. (Site: <http://hdsc.nws.noaa.gov/hdsc/pfds/>)

In locations where no rainfall intensity mapping is available, proposed orographic factors must be submitted for approval by PM&E.

The orographic factor should be interpolated to the nearest hundredth measured at the centroid of the contributing area. Where the contributing area covers more than two contour intervals on the published maps, determine the orographic factor by performing an area-weighted average of all contour intervals within the contributing area or by analyzing the contributing area as multiple subwatersheds.

Girdwood. The Girdwood climate and rainfall patterns are distinctly different from the Anchorage Bowl or Eagle River areas. For this reason, separate design storms have been provided for this region.

Table 4.2-1: MOA Design Storm Depths

Design Requirement	Design Storm	Application	Anchorage and Eagle River Total Depth (inches)	Girdwood Total Depth (inches)
Conveyance Design	10-year, 24-hour	Minor Drainageway ¹ and Major Drainageway ¹	2.28	5.72
	25-year, 24-hour	Non-Regulated Streams	2.79	6.69
	100-year, 24-hour	Regulated Streams	3.59	8.20
Water Quality Treatment	90 th Percentile, 24-hour	Green Infrastructure Water Quality Treatment	0.52	0.52
Extended Detention	1-year, 24-hour	Channel Protection	1.04	3.35
Peak Flow Control	2-year, 24-hour	Peak Control / Channel Protection	1.40	4.05
	10-year, 24-hour	Peak Control / Channel Protection	2.28	5.72
	100-year, 24-hour	Peak Control / Channel Protection	3.59	8.20

(1) Higher design storms are required for regulated streams. See glossary for definitions.

4.2.3 Storm Duration

All design storms are based on a 24-hour duration event. When applying a method that requires use of storm parameters for a rainfall duration smaller than 24 hours (e.g., as in the Rational Method), the average intensity used in the calculation shall be determined through application of the IDF curve equations shown in Figures 4.2-1 and 4.2-2 for the appropriate return period. However, all hydrograph routing analyses and designs shall be based on depths specified for the 24-hour duration events.

4.2.4 Storm Distribution

Design storm distributions for MOA drainage applications were developed using NOAA Atlas 14 IDF data and utilizing the NRCS method presented in the draft Chapter 4 of NRCS's National Engineering Handbook. The method has been incorporated into the NRCS program WinTR-20. The program is set up such that IDF data from NOAA Atlas 14 can be input into the program, and the program will complete the computations necessary to generate a rainfall distribution. A distribution was developed for Anchorage and Eagle River

based on NOAA Atlas 14 data from AIA. A second distribution was developed for Girdwood based on data from the Alyeska station. The resulting hyetographs are presented in Appendix D.

Figure 4.2-3: Orographic Factor Map (Anchorage)

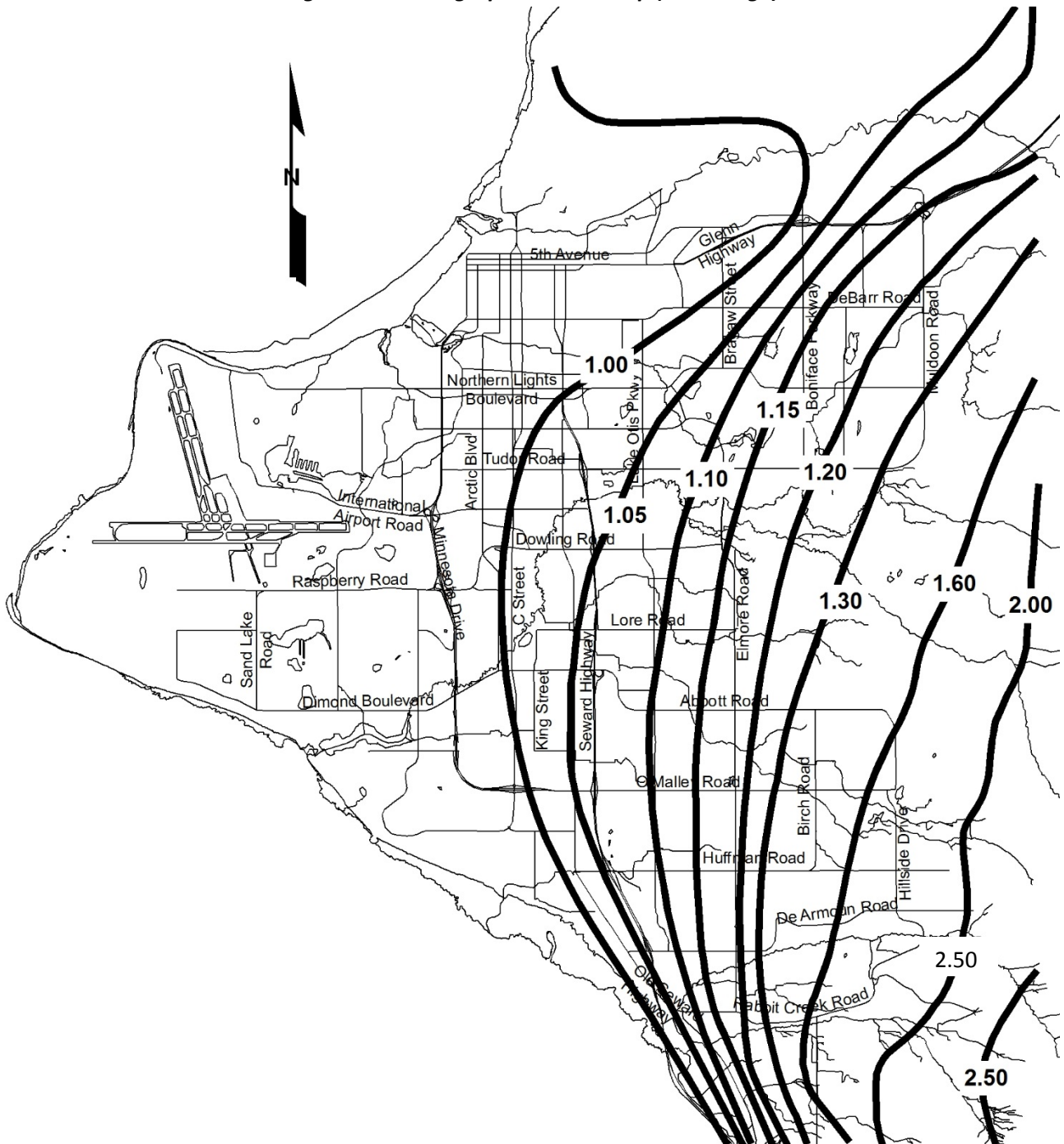

Figure 4.2-4: Orographic Factor Map (Eagle River)



4.3 Runoff Response

Once design storms are compiled and basin geometry is mapped, these data must be applied to calculate runoff flows and flow responses along drainage systems. The stormwater runoff response of a basin can be approximated by a number of techniques.

For basins that are relatively small and homogenous in terms of slope, soil, land cover, rainfall, and drainage systems, relatively simple methods can be applied to estimate this response. For many drainage design purposes within the MOA, analysis of runoff response can be spatially “lumped” across the entire basin where these homogenous conditions exist. That is, peak flows and runoff hydrographs can be estimated as an effect of the basin as a whole. For larger or more complex basins and groups of basins, separate estimation of runoff response may be required for each subwatershed using simple techniques, followed by application of routing techniques to the individual hydrographs to accurately assess the response of the entire complex.

Basic runoff response calculations typically include estimates of:

- A. Peak flows at design points;
- B. The required onsite retention/infiltration volume (per Stormwater Management Requirement 2);
- C. Changes in flow rates with time at design points (hydrographs); and
- D. Changes in combined flows along drainage networks and controls (routing).

Basic information and preliminary calculations required in a drainage analysis depends on the method chosen. However, for many simpler methods, estimating peak flows or developing runoff hydrographs at a design point very often requires some of the same initial calculations. These typically include:

- E. Representing the overall response of basin land cover to runoff in order to estimate precipitation losses;
- F. Representing and delineating a primary runoff flow path across the basin to estimate the time of concentration along the longest flow path in terms of time for a basin; and
- G. Estimating the time to peak flow (the lag time) or other factors in order to transform the runoff to a hydrograph at a design point.

Although each method used may require slightly different approaches in performing these tasks, many runoff models will require that these be addressed in some fashion.

It is very important that the same methodology must be used for estimating pre-development runoff response and post-development runoff response. If designers propose to use any significant modification of standard methods or parameters to fit particular circumstances, a variance must be requested that includes justification with published research, or other acceptable information as determined by PM&E.

4.4 Precipitation Losses

Storm runoff volume is the excess of rainfall available for runoff after initial abstractions and other losses have been satisfied. Separating precipitation losses from the runoff volume is typically the first step in calculating the overall runoff response of a basin. The range of methods used to estimate excess

precipitation can generally be classed as conceptual (based on mathematical representations of the discrete physical processes involved) or empirical (based on statistical evaluation of the measured overall responses of real basins).

Empirical methods typically rely on extrapolation to the specific design case from analyses of groups of other basins where overall responses have been measured. Empirical methods use overall rainfall runoff responses measured in other basins to model a basin with similar characteristics where no response measurements are available. These methods are less commonly used in Anchorage than conceptual methods.

Conceptual methods are commonly used to estimate excess precipitation in Anchorage. Conceptual methods typically account for each runoff element by application of formulas to represent important physical processes. Conceptual methods require a sound understanding of the physical processes occurring during a rainfall runoff event and some specific knowledge of the parameters at the project site necessary to model these processes. These parameters typically include depression storage (water trapped in small depressions on the surface), soil infiltration characteristics, and surface slopes. Evaporation may also be important when continuous simulation methods are used; however, for the more commonly performed single storm event (design storm) analysis, only antecedent soil moisture conditions need to be known. Conceptual methods are highly sensitive to parameters representing these elements, making it critical to identify and summarize the algorithms and parameters used in methods to estimate runoff. Therefore, where parameters assigned by a designer differ significantly from the norms specified in this manual, use of the parameters must be supported by documentation and submitted for approval by PM&E.

4.4.1 Precipitation Loss Methods

Table 4.4-1 provides a list of common precipitation loss calculation methods. These methods are used in conjunction with methods to estimate runoff response flows or hydrographs, as discussed in Section 4.5. Some precipitation loss methods are intended to be used in conjunction with a specific runoff response method. For example, the Rational Method Runoff Coefficient is intended to be used only with the Rational Method. Details regarding the method development and computation requirements are available in the references provided.

As described in Table 4.4-1, the Rational Method Runoff Coefficient and the Curve Number methods use a single numeric value to represent all precipitation losses including depression storage and infiltration. Numeric values for each of these methods are presented in Tables 4.4-2 and 4.4-3.

The Green-Ampt Method and Horton's Equation are used to represent infiltration. These methods do not account for losses from depression storage. When using these methods, depression storage losses should be accounted for separately. MOA-approved Depression Storage Values for various landcover types in are presented in Tables 4.4-4 and 4.4-5 and discussed in Section 4.4.1.2.

Table 4.4-1: Precipitation Loss Methods

Method	Description	Recommended Reference	Computer Models that Use Method
Rational Method Runoff Coefficient	Used only with the Rational Method. This coefficient represents overall losses and relates a maximum runoff to the net precipitation rate for a given storm based predominantly on land cover characteristics. See Table 4.4-2.	This Manual, Any Hydrology Reference	Pond Pack, Autodesk Storm and Sanitary Analysis
Curve Number	The curve number is used to quantify losses for all NRCS methods including the peak flow method, tabular hydrograph method, and unit hydrograph method. Curve Number is based on soil type and land cover. See Table 4.4-3 and Section 4.4.2.	NRCS Publication TR-55 (See Section 4.5.5)	HEC-HMS, Pond Pack, Autodesk Storm and Sanitary Analysis. <i>Note: Due to program complexities, this method is not acceptable for use within SWMM.</i>
Green-Ampt Method	This method is a physically based infiltration method that is available in most hydrologic computer models. It assumes that a short wetting front exists in the soil column, separating soil with some initial moisture content below from saturated soil above. Hydraulic parameters, including hydraulic conductivity, may be obtained from laboratory tests or from standard tables.	HEC-HMS Technical Reference Manual	HEC-HMS, SWMM, Autodesk Storm and Sanitary Analysis
Horton's Equation	Horton's Equation is based on empirical observations showing that infiltration decreases exponentially from an initial maximum rate to some minimum rate over the course of a long rainfall event. This method is integrated into the direct determination method for water quality volume estimation, which is presented in Section 4.5.1.	SWMM User's Manual and EPA Technical Guidance for Federal Facilities	SWMM, HEC-HMS, Autodesk Storm and Sanitary Analysis

Table 4.4-2: Rational Method Runoff Coefficients

Hydrologic Soils Group		A Soil			B Soil			C Soil			D Soil		
Slope		0-2%	2-6%	+6%	0-2%	2-6%	+6%	0-2%	2-6%	+6%	0-2%	2-6%	+6%
Land Cover	*												
Forest, brush	a	0.05	0.08	0.11	0.08	0.11	0.14	0.10	0.13	0.16	0.12	0.16	0.20
	b	0.08	0.11	0.14	0.10	0.14	0.18	0.12	0.16	0.20	0.15	0.20	0.25
Wetland	a							0.24	0.32	0.40	0.24	0.32	0.40
Parkland	a	0.05	0.10	0.14	0.08	0.13	0.19	0.12	0.17	0.24	0.16	0.21	0.28
	b	0.11	0.16	0.20	0.14	0.19	0.26	0.18	0.23	0.32	0.22	0.27	0.39
Cultivated	a	0.08	0.13	0.16	0.11	0.15	0.21	0.14	0.19	0.26	0.18	0.23	0.31
	b	0.08	0.14	0.22	0.16	0.21	0.28	0.20	0.25	0.34	0.24	0.29	0.41
Pasture	a	0.12	0.20	0.30	0.18	0.28	0.37	0.24	0.34	0.44	0.30	0.40	0.50
	b	0.15	0.25	0.37	0.23	0.34	0.45	0.30	0.42	0.52	0.37	0.50	0.62
Lawn	a	0.17	0.22	0.35	0.17	0.22	0.35	0.17	0.22	0.35	0.17	0.22	0.35
Barren	a	0.25	0.30	0.35	0.25	0.30	0.35	0.50	0.55	0.60	0.50	0.55	0.60
<i>Graded Slope</i>													
Gravel	a	0.25	0.30	0.35	0.25	0.30	0.35	0.50	0.55	0.60	0.50	0.55	0.60
Earthen	a	0.60	0.60	0.60	0.60	0.60	0.60	0.60	0.60	0.60	0.60	0.60	0.60
Drives, walks	a	0.75	0.80	0.85	0.75	0.80	0.85	0.75	0.80	0.85	0.75	0.80	0.85
<i>Streets</i>													
Gravel	a	0.50	0.55	0.60	0.50	0.55	0.60	0.50	0.55	0.60	0.50	0.55	0.60
Paved	a	0.85	0.86	0.87	0.85	0.86	0.87	0.85	0.86	0.87	0.85	0.86	0.87
	b	0.95	0.96	0.97	0.95	0.96	0.97	0.95	0.96	0.97	0.95	0.96	0.97
Impervious	a	0.85	0.86	0.87	0.85	0.86	0.87	0.85	0.86	0.87	0.85	0.86	0.87
	b	0.95	0.96	0.97	0.95	0.96	0.97	0.95	0.96	0.97	0.95	0.96	0.97

* - a, ≤ 10 -year, 24-hour event; b, > 10 -year, 24-hour event. Modified from: Rawls et al., 1981; WaDOT, March 2005.

NOTE: Soil compaction will impact runoff coefficients and should be considered when selecting a value from this table.

Table 4.4-3: NRCS (SCS) Curve Numbers

LAND COVER TYPE	HYDROLOGIC SOIL GROUP			
	A	B	C	D
	CURVE NUMBER			
Impervious Surfaces				
Streets & Roads				
Paved; curbs and storm sewers	98	98	98	98
Paved; open ditch including right-of-way	83	89	92	93
Gravel including right-of-way	76	85	89	91
Dirt, including right-of-way	72	82	87	89
Other Impervious Surfaces	98	98	98	98
Pervious Surfaces				
Bare	77	86	91	94
Lawn				
Steep Slopes (S>6%)	--	79	86	89
Moderate Slopes (2%<S<6%)	--	69	79	84
Flat Slopes(S<2%)	--	61	74	80
Other Landscaped Surfaces	--	Apply TR55 Table 2-2b, (NRCS, 1986)		
Naturally Vegetated Surfaces				
Natural Forest				
Poor condition (Forest litter, small trees, brush destroyed)	45	66	77	83
Fair (some forest litter)	36	60	73	79
Good (litter and brush adequately cover soil)	30	55	70	77
Natural Brush				
Poor condition (< 50% ground cover)	48	67	77	83
Fair condition (50% - 75% ground cover)	35	56	70	77
Good condition (> 75% ground cover)	30	48	65	73
Natural Grasslands	39	61	74	80
Wetlands				
Forested	--	--	30	30
Scrub/Shrub	--	--	30	30
Aquatic Herbaceous	--	--	58	58

Source: McCuen et al., 2002; NRCS,.

Note: Where ground is seasonally saturated at 3 feet or less below ground surface, use C or D HSG class Curve Numbers.

Note: --- indicates curve numbers for these Hydrologic Soil Groups are not applicable for MOA drainage studies.

4.4.1.1 Precipitation Losses for Wetlands and Lakes

It is important to note that the wetland values in Tables 4.4-2 and 4.4-3 are reflective of relatively low runoff potential and relatively high stormwater storage potential. In some cases, the designer will need to select higher numbers for wetlands based on site-specific conditions and the intended purpose of the hydrologic evaluation. For larger basins and conveyance evaluations such as sizing storm drain trunk lines and creek channels, it is often necessary to assume saturated conditions at the time of the design event. In that case, there would be no wetland storage potential and these areas would be modeled with curve numbers and “C” values similar to impervious surfaces such as asphalt. Additionally, some wetland areas may have little to no storage available based on topography, base flow, or other site-specific conditions. It is the responsibility of the designer to select values that are appropriate for the analysis. The MOA may request larger wetland values for cases where downstream systems are sensitive or wetlands are believed to have low potential storage.

4.4.1.2 Depression Storage Values

Depression storage values represent the quantity of water than can be stored on the land surface before any runoff is generated. Depression storage values can vary by type of surface, surface slope, and rainfall intensity. Tables 4.4-4 and 4.4-5 present two sets of depression storage values for analyses in Anchorage. The values in Table 4.4-4 represent values associated with computations for capture or conveyance of storms such as the 10-yr, 25-yr, 50-yr, and 100-yr events.

Table 4.4-4: Depression Storage Values for Conveyance Design

Site Slope	Depression Storage Values (inches)				
	Impervious Street or Driveway	Lawn/Landscaped	Barren Surface	Naturally Vegetated	
				Forest	Wetland
0-2%	0.1	0.25	0.15	0.25	0.25
2-6%	0.06	0.15	0.1	0.15	0.15
+6%	0	0.05	0.05	0.05	0.05

The values in Table 4.4-5 represent values that are reasonable for use when sizing stormwater treatment facilities intended to capture and treat smaller quantities of water, such as those used to meet the Stormwater Management Requirement 1. (See Section 4.5.1.)

Table 4.4-5: Depression Storage Values for Water Quality Treatment

Site Slope	Depression Storage Values (inches)				
	Impervious Street or Driveway	Lawn/Landscaped	Barren Surface	Naturally Vegetated	
				Forest	Wetland
0-2%	0.1	0.25	0.15	1.02	2
2-6%	0.06	0.15	0.1	1.02	1.02
+6%	0	0.05	0.05	0.52	1.02

The primary difference in the two sets of values is for forest and wetlands. The values in Table 4.4-4 are reduced compared to those in Table 4.4-5 because for capture and conveyance of larger events, we must assume that forests and wetlands are at least partially saturated at the beginning of the design event. Historically, design events in Anchorage occur most frequently in the fall following several days or weeks of frequent rain. For stormwater treatment design, we assume that the rainfall begins following 48 hours of no precipitation, and forests and wetlands will have more storage available.

4.4.2 NRCS (SCS) Soil Classifications

The NRCS soil classifications are used with NRCS methods for estimated losses. Additionally, these soil groups help when evaluating other parameters used to transform excess rainfall into runoff quantities. The slope of the soil surface is not considered when assigning hydrologic soil groups. Below is a brief summary of each soil group.

Group A—Soils in this group have low runoff potential when thoroughly wet. Water is transmitted freely through the soil. Group A soils typically have less than 10 percent silt or clay and more than 90 percent sand or gravel and have gravel or sand textures. Some soils having loamy sand, sandy loam, loam, or silt loam textures may be placed in this group if they are well aggregated, of low bulk density, or contain greater than 35 percent rock fragments. Anchorage does not have many naturally occurring Type A soils.

Group B—Soils in this group have moderately low runoff potential when thoroughly wet. Water transmission through the soil is unimpeded. Group B soils typically have between 10 percent and 20 percent silt or clay and 50 percent to 90 percent sand and have loamy sand or sandy loam textures. Some soils having loam, silt loam, silt, or sandy clay loam textures may be placed in this group if they are well aggregated, of low bulk density, or contain greater than 35 percent rock fragments.

Group C—Soils in this group have moderately high runoff potential when thoroughly wet. Water transmission through the soil is somewhat restricted. Group C soils typically have between 20 percent and 40 percent silt or clay and less than 50 percent sand and have loam, silt loam, sandy clay loam, clay loam, and silty clay loam textures. Some soils having silt or clay, silty clay, or sandy silt/clay textures may be placed in this group if they are well aggregated, of low bulk density, or contain greater than 35 percent rock fragments.

Group D—Soils in this group have high runoff potential when thoroughly wet. Water movement through the soil is restricted or very restricted. Group D soils typically have greater than 40 percent silt or clay, less

than 50 percent sand, and have silt-like or clay-like textures. In some areas, they also have high shrink-swell potential. All soils with a depth to a water impermeable layer less than 50 centimeters [20 inches] and all soils with a water table within 60 centimeters [24 inches] of the surface are in this group, although some may have a dual classification if they can be adequately drained.

4.5 Transforming Excess Rainfall Into Runoff Quantities

There are a number of hydrologic methods that can be used to estimate runoff characteristics for a site or drainage subwatershed; however, the methods presented in Table 4.5-1 have been selected to support hydrologic site analysis for the MOA. These methods were selected based on applicability to local conditions, analytical complexity, and the availability of equations, nomographs, and computer programs to support the methods.

Table 4.5-1: Runoff Calculation Methods

Method	Size Applicability	Notes	Computer Models that Use Method
Runoff Volume Methods			
Direct Determination Method	N/A	Method should be used for determining a volume of runoff for a specific design event (i.e., the 0.52-inch 90 th -percentile event). This method is acceptable for determining the water quality volume required for treatment using Green Infrastructure, or the total runoff generated from other storm events.	N/A ¹
Peak Flow Methods			
Rational Method	< 200 Acres	Method can be used for estimating peak flows from small sites. Not applicable for storage design.	Pond Pack, Autodesk SSA
NRCS Peak Flow Method	0-2,000 Acres	Method can be used for estimating peak flows for most design applications. Not applicable for storage design. Recommended for use with curve numbers greater than 50.	Pond Pack, WIN-TR55, Autodesk SSA
USGS Regression Equations	≤ 0.4 square miles ²	Method can be used to approximate peak flows in large, naturally occurring streams.	USGS Companion Spreadsheet
Hydrograph Methods			
NRCS Tabular Hydrograph Method	0-2,000 Acres	Method can be used to develop a hydrograph for times of concentration up to two hours. Due to computational complexity, this method is typically used within a computer model.	WIN-TR55, Autodesk SSA
NRCS UH Method	N/A	Method is widely used for developing runoff hydrographs. Due to computational complexity, this method is typically used within a computer model.	HEC-HMS, Pond Pack, Autodesk SSA
Kinematic Wave Method	N/A	Due to computational complexity, this method is typically used within a computer model.	HEC-HMS
Non-Linear Reservoir Routing	N/A	This method is applicable to highly urban areas. It is not applicable to highly vegetated areas, such as the Anchorage Hillside. Due to computational complexity, this method is typically used within a computer model.	HEC-HMS, SWMM, Autodesk SSA

(1) While this method is not directly available in SWMM, SWMM will generally produce very similar results.

(2) Other area limitations apply. See Section 4.5.4 for details.

Note that Table 4.5-1 has been separated into runoff volume methods, peak flow methods, and continuous flow or hydrograph methods.

1. Direct Determination Method - Describes a simple calculation for determining a total volume of runoff.
2. Peak Flow Methods - Typically predicts the maximum expected flow from a basin (or contributing area) evaluated at a specific point. These methods can be used for sizing conveyance infrastructure for specific flow conditions. Peak flow methods are not appropriate for determining runoff volume, developing runoff hydrographs, or sizing detention and retention facilities.
3. Hydrograph Methods - A hydrograph represents the change in flow at a specific point over a selected time duration or the response of the watershed over time.

A brief description of each method is provided in below. Detailed information regarding the development and computations for each method is beyond the scope of this manual. It is expected that sufficient information is presented for each method's target audience. Additionally, recommended references for detailed information about each method are provided.

4.5.1 Direct Determination Method

The direct determination method can be used to determine the total volume of runoff from a site, after taking out losses from initial abstractions and infiltration. The direct determination method or runoff volumes generated by SWMM are the only methods accepted by the MOA for estimating the volume of runoff required for water quality treatment through Green Infrastructure. In the direct determination method, runoff from each land cover is estimated using a simplified volumetric approach based on the following equation:

$$\text{Runoff} = \text{Rainfall} - \text{Depression Storage} - \text{Infiltration Loss}$$

This methodology does not consider routing of runoff; therefore slope is not considered when calculating on a volumetric basis.

Depression storage parameters are presented in Tables 4.4-4 and 4.4-5. If the direct determination method is being used for sizing Green Infrastructure facilities to meet Stormwater Management Requirement 1, Table 4.4-5 would be used.

Infiltration loss is calculated only in pervious areas (e.g., there is no infiltration in impervious areas). Infiltration is calculated using Horton's equation:

$$F_t = f_{min} + (f_{max} - f_{min}) * e^{-kt}$$

Where:

F_t = infiltration rate at time t (in/hr),

f_{min} = minimum or saturated infiltration rate (in/hr),

f_{max} = maximum or initial infiltration rate (in/hr),

k = infiltration rate decay factor (hr^{-1}), and

t = time (hr) measured from time runoff first discharged into infiltration area.

Infiltration loss for a 24-hour rainfall duration is estimated by the following equation with assumptions of

a half hour Δt and uniform rainfall distribution in time:

$$\text{Infiltration Loss} = \sum (f * \Delta t)$$

Tables 4.5-2 and 4.5-3 present maximum and minimum infiltration parameters for various soil types, and Table 4.5-4 presents associated decay rates.

Table 4.5-2: Typical Maximum Infiltration Rate

Soils	Infiltration (in/hr)			
	Partially dried out with		Dry soils with	
	No Vegetation	Dense Vegetation	No Vegetation	Dense Vegetation
Sandy	2.5	5	5	10
Loam	1.5	3	3	6
Silt or Clay	0.5	1	1	2

Source: EPA Technical Guidance on Implementing Stormwater Runoff Requirements for Federal Projects 2009

Table 4.5-3: Typical Minimum Infiltration Rate

Hydrologic Soil Group	Infiltration (in/hr)
A	0.45 – 0.30
B	0.30 – 0.15
C	0.15 – 0.05
D	0.05 - 0

Source: EPA Technical Guidance on Implementing Stormwater Runoff Requirements for Federal Projects 2009

Table 4.5-4: Typical Decay Coefficient

Soils	k (sec ⁻¹)	k (hr ⁻¹)
Sandy  Silt or Clay	0.00056	2
	0.00083	3
	0.00115	4
	0.00139	5

Source: EPA Technical Guidance on Implementing Stormwater Runoff Requirements for Federal Projects 2009

Once runoff from each land cover is estimated, the total runoff from a site can be obtained using an area-weighted calculation as shown below:

$$\text{Runoff}_{\text{site}} = [(\text{Runoff}_{\text{roof}} * A_{\text{roof}}) + (\text{Runoff}_{\text{pavement}} * A_{\text{pavement}}) + (\text{Runoff}_{\text{pervious}} * A_{\text{pervious}})] / A_{\text{site}}$$

Where:

$\text{Runoff}_{\text{site}}$ = total runoff from the site (inches),

A_{site} = site area (acres),

$\text{Runoff}_{\text{roof}}$ = runoff from rooftop (inches),

A_{roof} = rooftop area (acres),

$\text{Runoff}_{\text{pavement}}$ = runoff from pavement area (inches),

A_{pavement} = pavement area (acres),

$\text{Runoff}_{\text{pervious}}$ = runoff from pervious area (inches), and

A_{pervious} = pervious area (acres).

Recommended Reference: Technical Guidance on Implementing the Stormwater Runoff Requirements for Federal Projects, Section 438 of the Energy Independence and Security Act (<http://www.epa.gov/owow/NPS/lid/section438/>).

4.5.2 Rational Method

The rational method is based on the principle that the maximum rate of runoff from a drainage basin occurs when all parts of the watershed contribute to flow and that rainfall is distributed uniformly over the basin. This method does not account for routing of flow through a watershed, stormwater collection systems, or storage facilities. Therefore, this method should only be used if the accuracy of runoff values is not essential. This method is generally appropriate for estimates of peak runoff rates for small contributing basins (200 acres or less) with times of concentration of 20 minutes or less. (See Section 4.6 for a discussion of time of concentration.) This method should not be used to determine runoff volume or generate hydrographs for sizing detention or retention facilities.

The rational method equation is:

$$Q_p = C i A$$

Where:

Q_p = Peak runoff rate in cubic feet per second (cfs),

i = Rainfall intensity in inches per hour (iph) for a duration equal to the basin time of concentration,

C = Runoff coefficient (unitless) that varies with land cover type and is used to account for rainfall abstractions,

A = Drainage area in acres.

Rainfall intensity values for the MOA are presented in Figures 4.2-1 and 4.2-2. Runoff coefficients for various land cover types are presented in Table 4.4-2. For non-homogenous drainage basins having many land cover types, a composite C (C_c) value should be calculated as:

$$C_c = \frac{\sum_{j=1}^n C_j A_j}{\sum_{j=1}^n A_j}$$

Where:

A_j = Area of land cover j ,

C_j = Runoff coefficient for area j , and

n = Total number of land cover types being evaluated.

Recommended Reference: Any hydrology text; Comprehensive Urban Hydrologic Modeling Handbook, Nicklow et. al, 2006

4.5.3 NRCS (SCS) Peak Flow Method (Tabular Method)

The SCS peak flow method (also known as the NRCS peak flow method) can be used to determine peak flow for small and mid-sized basins (2,000 acres or less). This method is recommended for basins with weighted curve numbers greater than 40 (weighted curve numbers are computed similarly to weighted rational method runoff coefficients). This method is generally simple to use and does not require detailed input parameters. Details regarding application of this method are provided in numerous hydrology texts as well as in the NRCS publication TR-55 and the NRCS National Engineering Handbook (NEH), Part 630 Hydrology. A brief presentation of the method is given below.

The NRCS Peak Flow equation is given as:

$$q_p = q_u A Q F_p$$

Where:

q_p = Peak runoff rate in cfs,

q_u = Unit peak discharge in cfs/mi²/in,

Q = 24-hour rainfall excess in inches for a given return period, and

F_p = Pond and swamp adjustment factor.

Guidelines for selecting and/or calculating Q , F_p and q_u are available in most standard hydrology references as well as the NRCS publications described above.

Recommended Reference: NRCS TR-55
(<ftp://ftp.wcc.nrcs.usda.gov/wntsc/H&H/other/TR55documentation.pdf>).

4.5.4 USGS Regression Equations

The United States Geological Survey (USGS) has developed regression equations for determining peak flows on ungaged streams in Alaska. (Note that peak flows on gaged sites should be computed through completion of an appropriate flood frequency analysis.) The regression equations and associated methodology are presented in the publication *Estimating Flood Magnitude and Frequency at Gaged and Ungaged Sites on Streams in Alaska and Conterminous Basins in Canada, Based on Data through Water Year 2012*. (A link to this publication is provided below.) The publication provides empirical regression

equations to computing peak flows for the 2-, 5-, 10-, 25-, 50-, 100-, 200-, and the 500-year recurrence intervals.

The independent parameters in the regression equations are drainage basin area and mean annual precipitation. The equations are only valid when rainfall values are obtained from the Parameter-Elevation Regressions on Independent Slopes Model (PRISM) Alaska data set, 1971-2000, as referenced in the USGS publication. The PRISM rainfall data are presented as GIS raster files. The raster files associate mean average annual precipitation with geographic area. The PRISM raster resolution is 771 meters (0.48 miles). The basin average mean annual precipitation should be computed by using ArcGIS to clip the raster to the drainage basin extents and compute an area-weighted average precipitation value based on the values of each raster tile.

The USGS regression equations are considered valid for drainage areas between 0.4 and 1,000 square miles with basin mean annual rainfall between 8 and 280 inches, and for drainage areas greater than 1,000 square miles with basin mean annual rainfall between 10 and 111 inches.

These equations should not be used for small urban drainage analyses.

The regression equations are available from USGS at the reference below. The publication includes a companion spreadsheet for computing peak flows and provides a link for obtaining the PRISM rainfall data.

Recommended Reference: USGS “Estimating Flood Magnitude and Frequency at Gaged and Ungaged Sites on Streams in Alaska and Conterminous Basins in Canada, Based on Data through Water Year 2012.” (<https://pubs.er.usgs.gov/publication/sir20165024>).

4.5.5 NRCS (SCS) Tabular Hydrograph Method

The Tabular Hydrograph Method is essentially a continuation of the NRCS Peak Flow method described above. The NRCS tabular hydrograph method is used for computing discharges from rural and urban areas, using the time of concentration (T_c) and travel time (T_t) from a sub-area as inputs. (See Section 4.6 for a discussion of time of concentration.) The NRCS TR-55 methodology can determine peak flows from areas of up to 2,000 acres (as discussed in Section 4.5.3 above), provide a hydrograph for times of concentration of up to two hours, and estimate the required storage for a specified outflow. The tabular method can develop partial composite flood hydrographs at any point in a watershed by dividing the watershed into homogeneous sub-areas. In this manner, the method can estimate runoff from non-homogeneous watersheds. The method is especially applicable for estimating the effects of land use change in a portion of a watershed. It can also be used to estimate the effects of proposed structures. Input data needed to develop a partial composite flood hydrograph include (1) 24-hour rainfall (in), (2) appropriate rainfall distribution (I, IA, II, or III), (3) CN, (4) T_c (hr), (5) T_t (hr), and (6) drainage area (mi²). A detailed description of this method, a discussion of the method’s limitations, and completed examples of developing a tabular hydrograph are available in the NRCS publication TR-55.

Recommended Reference: NRCS TR-55 (<ftp://ftp.wcc.nrcs.usda.gov/wntsc/H&H/other/TR55documentation.pdf>).

4.5.6 Unit Hydrographs

Unit Hydrograph (UH) theory assumes that watersheds behave as linear systems. The following are the fundamental assumptions of UH theory.

- A. The duration of direct runoff is always the same for uniform-intensity storms of the same duration, regardless of the intensity. This means that the time base of the hydrograph does not change and that the intensity only affects the discharge.
- B. The direct runoff volumes produced by two different excess rainfall distributions are in the same proportion as the excess rainfall volume. This means that the ordinates of the UH are directly proportional to the storm intensity. If storm A produces a given hydrograph and storm B is equal to storm A multiplied by a factor, then the hydrograph produced by storm B will be equal to the hydrograph produced by storm A multiplied by the same factor.
- C. The time distribution of the direct runoff is independent of concurrent runoff from antecedent storm events. This implies that direct runoff responses can be superposed. If storm C is the result of adding storms A and B, the hydrograph produced by storm C will be equal to the sum of the hydrographs produced by storm A and B.
- D. Hydrologic systems are usually nonlinear due to factor such as storm origin and patterns and stream channel hydraulic properties. In other words, if the peak flow produced by a storm of a certain intensity is known, the peak corresponding to another storm (of the same duration) with twice the intensity is not necessarily equal to twice the original peak.
- E. Despite this nonlinear behavior, the unit hydrograph concept is commonly used because, although it assumes linearity, it is a convenient tool to calculate hydrographs and it gives results within acceptable levels of accuracy.
- F. The alternative to UH theory is kinematic wave theory and distributed hydrologic models, discussed in Section 4.5.7 below.

4.5.6.1 NRCS (SCS) Dimensionless Unit Hydrograph Method

The NRCS Dimensionless Unit Hydrograph can be used to develop a synthetic hydrograph for large and small watersheds. The NRCS dimensionless unit hydrograph (1985) is frequently used in practice, is well-documented, and is recommended for design of structural stormwater controls where hydrographs are needed. Many variables are integrated into the shape of a unit hydrograph. Since a dimensionless unit hydrograph is used and the only parameters readily available from field data are drainage area and time of concentration, consideration should be given to dividing the watershed into hydrologic units of uniformly shaped areas. These subareas, if at all possible, should have a homogeneous drainage pattern, homogeneous land use, and should be approximately the same size. To assure that all contributing subareas are adequately represented, NRCS suggests that no subarea exceed 20 square miles in area and that the ratio of the largest to the smallest drainage area not exceed 10 square miles. The process for developing and NRCS Dimensionless Unit Hydrograph is explained in detail in Chapter 16 of the NRCS National Engineering Handbook. This method is typically used in conjunction with a computer model due to the computations involved.

Recommended References: (1) *NRCS National Engineering Handbook Chapter 16* (<ftp://ftp.wcc.nrcs.usda.gov/wntsc/H&H/NEHhydrology/ch16.pdf>). (2) *HEC-HMS Technical Reference Manual* (<http://www.hec.usace.army.mil/software/hec-hms/documentation.html>).

4.5.7 Kinematic-Wave Method

The Kinematic Wave model is based on a combination of the full continuity and momentum equations for steady, uniform flow. These equations are solved using finite difference methods. These calculations are best performed using a computer program such as HEC-HMS. Details regarding the derivation of the Kinematic Wave Method are available in most hydrology text books as well as the HEC-HMS Technical Reference Manual.

Recommended Reference: *HEC-HMS Technical Reference Manual* (<http://www.hec.usace.army.mil/software/hec-hms/documentation.html>).

4.5.8 Non-Linear Reservoir Method

The Non-linear Reservoir method simulates a watershed as a shallow reservoir in which inflow is equal to the rainfall excess, and outflow is a nonlinear function of the depth of flow. Due to computational complexity, this method is typically used within a computer model. This method is the hydrograph method used by the program SWMM, and is generally recommended for highly urban areas. This method is not applicable to non-urban drainage basins, such as the MOA Hillside area. Details regarding the development and computations of this method can be found in most hydrology text books.

Recommended Reference: Comprehensive Urban Hydrologic Modeling Handbook for Engineers and Planners, Nicklow et. al.

4.6 Time of Concentration

Many of the methods for computing runoff quantities presented in Section 4.5 require computation of the basin's time of concentration (T_c). Time of concentration is defined as the time for runoff to travel from the hydraulically most distant point of a watershed to the design point or point of interest.

Because T_c cannot be directly measured, it is often estimated based on travel times. Travel time is the time it takes water to travel from one location to another in a watershed. Time of concentration is often computed by summing all of the travel times along the longest hydraulic flow path. It is worth noting that the longest "hydraulic" flow path may not necessarily be the longest physical distance due to factors such as slope and surface roughness. Travel times are computed along appropriately partitioned flow paths that include both overland/sheet flow and more concentrated channel flow components. Travel times can depend on many factors including basin size, topography, land and use. Climatic factors, such as rainfall intensity and duration, play an equally important role.

There are many different empirical and physically-based methods available to determine a basin's time of concentration. Some runoff response methods require a specific method for computing time of concentration. For example, TR-55 outlines a specific methodology for computing T_c that should be used with the NRCS runoff methods. Other runoff response methods do not specify how to obtain T_c , and it is up to the designer to select the method and parameters that are appropriate for the basin. The selection requires careful consideration of applicability and limitation of each method and the conditions under

which it was derived. *In many cases, different methods may be required to account for overland/sheet flow, shallow concentrated flow, and channel flow. In these cases, the total T_c is the sum of the travel times for each type of flow.* Designers should ensure the method selected is appropriate to the design conditions.

Because different methods often yield significantly different results, it is recommended that T_c be computed using more than one method and qualitative judgment be used to select a single value.

Detailed descriptions and derivations of the T_c methods is beyond the scope of this manual. Instead, Table 4.6-1 presents several published used T_c methods, their typical applicability, and a recommended reference to obtain more information. Of the methods presented, the most commonly used in Anchorage are the Kinematic Wave method, the Modified Kinematic Wave method, the NRCS Upland method (methods 1-3 in Table 4.6-1). If a designer wishes to use methods 4 through 8, justification of why the method is appropriate to the site is required.

Table 4.6-1: Time of Concentration Equations

Method	Formula	Comments
1. Kinematic Wave	$T_c = \frac{0.938 L^{0.6} n^{0.6}}{i^{0.4} S^{0.3}}$	n in this equation is Manning's n for overland flow. (See Table 4.6-2). This is an iterative solution, because both T_c and i are not known. Begin with an assumed value of i , compute T_c , and check the relationship using the IDF curves. Repeat until the solution converges.
2. Modified Kinematic Wave	$T_c = \frac{0.42 L^{0.8} n^{0.8}}{P_{24}^{0.5} S^{0.4}}$	Applicable only to overland/sheet flow. This modification of the Kinematic Wave method eliminates the need for an iterative solution. P_{24} is the 2-year, 24-hour rainfall depth in inches, regardless of which storm event the system is being designed to accommodate.
3. NRCS Upland Method	$T_c = \sum_{j=1}^N \frac{L_j}{V_j}$	For shallow concentrated flow or channel flow, average velocity, V , in segment j can be computed via Manning's equation; for overland flow, see NRCS charts (TR-55) for plotting V as a function of surface cover and slope, or see the Modified Kinematic Wave Equation above.
4. NRCS Lag Equation	$T_c = \frac{100L^{0.8} \left[\left(\frac{1000}{CN} \right) - 9 \right]^{0.7}}{19000S^{1/2}}$	Curve Number (CN) is from Table 4.4-3
5. Kirpich	$T_c = 0.0078L^{0.77} S^{-0.385}$	For overland flow on concrete or asphalt, multiply T_c by 0.4; for concrete channels, multiply by 0.2.
6. Izzard	$T_c = \frac{41.025 (0.007i + c)L^{1/3}}{S^{1/3} i^{2/3}}$	Applicable for $iL < 500$; Retardance Factor, c , ranges from 0.007 for smooth pavement to 0.012 for concrete and to 0.06 for dense turf.
7. FAA	$T_c = \frac{0.39 (1.1 - C)L^{1/2}}{S^{1/3}}$	Runoff coefficient, C from Table 4.4-2
8. Yen and Chow	$T_c = K_Y \left(\frac{NL}{S^{1/2}} \right)^{0.6}$	K_Y ranges from 1.5 for light rain ($i < 0.8$) to 1.1 for moderate rain ($0.8 < i < 1.2$) and to 0.7 for heavy rain ($i > 1.2$); Overland texture factor, N , in Table 4.6-3.

Source: *Comprehensive Sewer Collection Systems Analysis Handbook*, Nicklow et. al, 2004.

Recommended References: (1) *Comprehensive Urban Hydrologic Modeling Handbook*, Nicklow et. al, 2006 and (2) NRCS TR-55.

Note: T_c is evaluated in minutes; L is the length of the flow path in feet; i is the rainfall intensity in inches/hour; and S is the average slope in feet/foot.

When computing T_c for Anchorage, the following requirements apply:

1. Maximum distance for overland or sheet flow is 150 feet.
2. The minimum allowable T_c is five minutes. If the computed T_c is less than five minutes, five minutes shall be applied.
3. Manning's "n" values shall be for overland/sheet flow. See table 4.6-2.

Table 4.6-2 Manning's Roughness Coefficients for Overland and Sheet Flow

N Value	Surface Description
Constructed Surfaces	
0.011	Smooth asphalt
0.012	Smooth concrete
0.013	Concrete lining
0.014	Good wood, brick with cement mortar
0.015	Vitrified clay, cast iron
0.024	Corrugated metal pipe, cement rubble surface
<i>Cultivated Soils</i>	
0.050	Fallow (no residue)
0.060	Residue cover $\leq 20\%$
0.170	Residue cover $\geq 20\%$
0.130	Range (natural)
<i>Grass Surfaces</i>	
0.150	Short grass prairie
0.240	Dense grasses (lawns)
0.410	Bermuda grass
<i>Woods and Stem Vegetation*</i>	
0.400	Light underbrush
0.800	Dense underbrush
	*For woody stems, consider cover to height of 30 mm (0.1 ft) only

Source: McCuen, et al., 2002

Table 4.6-3 Overland Texture Factor, N, for Yen and Chow Time of Concentration

Overland Flow Surface	Low	Medium	High
Smooth asphalt pavement	0.010	0.012	0.015
Smooth impervious surface	0.011	0.013	0.015
Tar and sand pavement	0.012	0.014	0.016
Concrete pavement	0.014	0.017	0.020
Rough impervious surface	0.015	0.019	0.023
Smooth bare packed soil	0.017	0.021	0.025
Moderate bare packed soil	0.025	0.030	0.035
Rough bare packed soil	0.032	0.038	0.045
Gravel soil	0.025	0.032	0.045
Mowed poor grass	0.030	0.038	0.045
Average grass, closely clipped sod	0.040	0.050	0.060
Pasture	0.040	0.055	0.070
Timberland	0.060	0.090	0.120
Dense grass	0.060	0.090	0.120
Shrubs and bushes	0.080	0.120	0.180
Land Use	Low	Medium	High
Business	0.014	0.022	0.035
Semi-business	0.022	0.035	0.050
Industrial	0.020	0.035	0.050
Dense residential	0.025	0.040	0.060
Suburban residential	0.030	0.055	0.080
Parks and lawns	0.040	0.075	0.120

Source: *Comprehensive Sewer Collection Systems Analysis Handbook*,
Nicklow et. al, 2004

4.7 Routing Stormwater Runoff

Stormwater runoff routing is a process that involves evaluating the spatial and temporal variation of stormwater discharge through a watercourse, based on hydrographs. Routing is necessary for describing runoff from large, non-homogenous basins that cannot be accurately described by a single hydrograph. It is also necessary when drainage networks or downstream impacts are being evaluated.

Flow routing can be computationally simple for small, homogenous drainage basins or highly complex for larger, non-homogeneous basins or systems of basins. For this reason, flow routing is typically performed with the aid of a computer model. The discussion of flow routing in this manual is limited to a discussion of a few of the common methods available with commonly used computer models presented in Table 4.8-1. It is the responsibility of the designer to determine the applications and limitations of the selected routing method and to select a method appropriate for the given study. Detailed, easy-to-follow information regarding flow routing is available in the following reference documents:

- ~ NRCS National Engineering Handbook,
- ~ HEC-HMS Technical Reference Manual,
- ~ SWMM User's Manual, and
- ~ Comprehensive Urban Hydrologic Modeling Handbook (Nicklow, et. al.).

4.7.1 Steady Flow Routing

Steady flow routing is one of the simplest routing methods available. This method assumes that flow is uniform and steady for each computational time step. Thus, this model cannot account for channel storage, backwater effects, entrance and exit losses, flow reversal, or pressurized flow. Generally, steady flow routing is appropriate for very simple systems or preliminary analyses.

4.7.2 Kinematic Wave Routing

Kinematic Wave routing solves the continuity equation with a simplified form of the momentum equation for each defined conduit of the watershed. This method allows flow and area to vary spatially and temporally within a conduit. However, this method cannot account for backwater effects, entrance and exit losses, flow reversal, or pressurized flow. The maximum amount of water that a conduit can carry in this form of routing is its normal, flowing full value.

4.7.3 Dynamic Wave Routing

Dynamic Wave routing solves the complete, one-dimensional St. Venant flow equations (continuity and momentum), which makes this routing method able to represent pressurized flow, channel storage, backwater, entrance and exit losses, and flow reversal. This method is usually preferred for complex hydrologic conditions, flat to moderately sloped open channel systems, systems with backwater effects or flow reversal, and modeling storm drain networks. Although not discussed in this manual, an advanced form of this analysis is two-dimensional flow analysis.

4.8 Computer Models

When performing hydrologic and hydraulic analyses, it is often helpful to use computer models to assist with complex flow routing and to aid in representation of complex, non-uniform flow conditions. There are a wide variety of computer models available for both hydrologic and hydraulic analyses. Table 4.8-1 includes a list of common computer models that support the hydrologic methods presented in this manual. It is the responsibility of the designer to select the model that most accurately represents the conditions to be modeled. For example, HEC-RAS, SWMM, and HEC-HMS include hydraulic components, but each has its own limitations. HEC-RAS is appropriate for open channel analysis, SWMM is typically more useful for modeling piped channels, and HEC-HMS may be used to route open channel flow from computational node to computational node using less robust hydrologic routing methods. HEC-HMS does not currently support modeling situations where downstream conditions have a significant effect on flow, as with open channel dams or other check structures and some culverts.

This list is not comprehensive. The designer may elect to use other computer models that incorporate the methodologies presented in this manual.

When computer models are used for drainage analysis and design, the designer is provide model input and output parameters as part of the project's drainage review request. See Section 3 of this manual for complete reporting requirements.

Table 4.8-1: Common Computer Models

Model	Owner or Developer	Hydrology, Hydraulics, or Both	Description	Common Application ¹
SWMM	US Environmental Protection Agency	Both	SWMM is both a hydrologic model and a hydraulic model. The hydraulic component of SWMM is well-suited for representation of simple or complex pipe flow.	Storm drain design, urban hydrograph development, multiple reservoir routing (as in connected detention basins), detention and retention design.
HEC-HMS	US Army Corps of Engineers	Both – Limited Hydraulics	HEC-HMS is a widely used hydrologic model that incorporates many of the runoff methodologies presented in this manual. HEC-HMS also has a somewhat limited hydraulic component that may be applicable to some situations. The model should not be used for modeling complex hydraulics.	Hydrograph development, hydrograph routing, simple open channel design, detention and retention design.
Pond Pack®	Bentley®	Both – Limited Hydraulics	PondPack is a program that can model a range of projects from basic site designs to more complex drainage studies. The program can model runoff and storage facilities, but should not be used for complex hydraulics.	Hydrograph development, hydrograph routing, simple open channel design, detention and retention design.
HEC-RAS	US Army Corps of Engineers	Hydraulics	HEC-River Analysis System (RAS) is a hydraulic model designed for open channels and culverts. This model will perform one-dimensional steady and unsteady open channel hydraulics.	Large open channels, networks of open channels, river or stream systems, culverts or bridges in series.
HY-8	Federal Highway Administration	Hydraulics	HY-8 is a culvert hydraulic model. This program automates the design methods described in HDS No. 5, "Hydraulic Design of Highway Culverts." The model can represent both inlet and outlet control conditions and allows the user to specify a variety of tailwater conditions.	Culvert crossings where (1) flow is not expected to be influenced by an upstream or downstream structure, (2) extended water surface profile information upstream and downstream is not needed, and (3) only instantaneous flows require modeling (not hydrographs).
Autodesk Storm and Sanitary Analysis	Autodesk	Both	Autodesk SSA is a comprehensive hydrologic modeling software that incorporates many of the methods presented in this manual. It includes design engines from other public domain software such as SWMM and HEC-1.	Storm drain design, urban hydrograph development, multiple reservoir routing (as in connected detention basins), detention and retention design, simple open channel design.

(1) These are suggested uses and are not intended to fully describe the model's capabilities or limitations.

5.0 CONVENTIONAL STORMWATER FACILITIES

5.1 Introduction

This section presents the requirements for design of conventional stormwater conveyance infrastructure and drainage criteria for streets. Conventional conveyance facilities are systems intended to quickly capture and convey stormwater runoff or groundwater via a pipe or channel. Conveyance facilities are designed to carry peak flows from design storm events as described in the Section 3.

These requirements of this section do not apply to internal components of structural stormwater controls discussed in Section 6, such a rain garden underdrain, a pond outlet structure, etc. Those facilities shall follow the design criteria in Section 6.

5.2 Storm Events for Conveyance Design

Design for peak conveyance shall be based on the sum of all contributing flows, i.e., both project area flows and upstream and lateral inflows.

Conveyance systems are sized to pass peak runoff flows for the 24-hour duration design storm with a return period based on watercourse type as listed in Table 4.2-1. The peak runoff should be the controlled peak as required by stormwater management requirements described in Section 3.

5.3 Piped Storm Drain Systems

5.3.1 Objectives

Piped storm drain systems shall be designed to pass peak flows for the design storm based on contributing area or watercourse type, as applicable, presented in Table 4.2-1. The primary detriment of an underground system is the potential for adverse impacts on water quality.

The objective of this section is to provide design standards for various components of underground storm systems. Construction specifications on each component are found in the Municipality of Anchorage Standard Specifications (M.A.S.S.).

5.3.2 Pipe Sizing and Standards

Because of on-going corrosion problems in the Anchorage area, storm drain pipes shall be Type S Pre-coated Corrugated Metal Pipe (PCMP) or Type S Corrugated Polyethylene Pipe (CPEP). PCMP and connecting bands shall be coated to conform to the latest revisions of the American Association of State Highway and Transportation Officials (AASHTO) Standard Specifications: M245 and M246, and the coating shall be 10 mils minimum on each side. CPEP and fittings shall meet the latest revision of AASHTO Standard Specifications: M294 and M252 and have a smooth inner liner. The following criteria shall apply in the

design of storm drain systems:

- A. The diameter of simple storm drain pipe can be determined using the Manning's equation or other generally accepted engineering practice. Approved Manning's "n" values are provided in Table 5.3-1.
- B. Storm drain networks or storm drains that may experience backwater, flow reversal, significant entrance and exit losses, or pressurized flow cannot be accurately represented by Manning's equation. These systems require a more complex hydraulic routing analysis. Refer to Section 4.7.
- C. The minimum diameter of storm drain pipe is 12 inches.
- D. Catch basin lead minimum sizes are 10-inch diameter for the MOA and 12 inches in DOT&PF ROW.
- E. The minimum pipe slope is 0.3 percent unless otherwise approved.
- F. The pipe placement between manholes shall be in a straight line. A curved pipe alignment may be allowed for pipes over 36 inches in diameter upon approval by the Municipal Engineer.
- G. The storm drain system shall not be surcharged during the design storm event.
- H. If a variance for surcharging is authorized, the maximum allowable hydraulic grade line of the storm drain system at the design flow is 0.5 feet below the elevation of inlet grates and manhole covers.
- I. Water velocity in storm drain pipes is determined using Manning's equation or applicable hydraulic sizing method based on design conditions. At the design flow, the minimum pipe flow velocity is two feet per second (fps). For all pipe types other than HDPE, the maximum pipe flow velocity is 13 fps. For HDPE pipe, the maximum pipe flow velocity is 15 fps.
- J. State regulations (18 AAC 72.020) require minimum horizontal and vertical separations between storm drain facilities such as pipes, basins, structures, etc., and drinking water systems. Greater separations apply to public and private water sources (18 AAC 80.020). Separation distance between storm drain pipe and Anchorage Water and Wastewater Utility (AWWU) sanitary sewer or water facilities shall conform to AWWU requirements.
- K. The size and capacity of the system, including the outfall, shall be based on runoff flows and volumes assuming full development under existing zoning of the entire area that will contribute to the system. The drainage system shall be designed to account for both on-site and off-site surface waters and base flows, including footing and other subdrains.
- L. The drainage system shall be compatible with improvements and alignments proposed in existing drainage studies and as mapped by WMS.

Table 5.3-1: Manning’s “n” Values for Non-Pressurized Closed Conduits

Conduit Material	Manning’s “n”
Closed conduits	
Asbestos-cement pipe	0.011-0.015
Cast iron pipe (Cement-lined & seal coated)	0.011-0.015
Concrete pipe	0.011-0.015
Helically corrugated metal pipe (12” - 48”)	0.013-0.023
Smooth wall metal pipe	0.011-0.013
Corrugated metal pipe	
Plain annular	0.022-0.027
Plain helical	0.011-0.023
Paved invert	0.018-0.022
Spun asphalt lined	0.011-0.015
Spiral metal pipe (smooth)	0.012-0.015
Plastic pipe (corrugated)	
3- 8 in. diameter	0.014-0.016
10- 12 in. diameter	0.016-0.018
Larger than 12 in. diameter	0.019-0.021
Plastic pipe (smooth interior)	0.010-0.015
Vitrified clay	
Pipes	0.011-0.015
Liner plates	0.013-0.017
Open Channels – See discussion below	

Source: American Society of Civil Engineers. 2005. *Standard Guidelines for the Design of Urban Storm Sewer Systems*.

Note: The values in this table are not appropriate for approximation of overland/sheet flow. See Table 4.6-2 for Manning’s “n” values for overland/sheet flow.

The “n” values presented in Table 5.3-1 above are provided in a range to help the designer understand how the “n” value may vary based on pipe properties such as age and condition. In most cases, the actual Manning’s “n” value of pipe will change over time. The designer should consider the average condition over the expected life of the pipe when selecting a design value. Generally, a value in middle of the provided range is recommended for design of new pipe.

The selection of an appropriate Manning’s “n” for open channels is more complex than selecting a value for pipe flow. The value selection depends on many criteria including channel cross section shape, how winding the channel is, flow distribution across the channel, surface properties of the channel bottom, sides, and overbanks, etc. Selection of an appropriate “n” value is critical for many types of open channel design. A complete discussion of the procedure for selecting an open channel “n” value is beyond the scope of this manual, but three references are provided below to aid the designer in determining an appropriate value. The designer may be required to provide justification for the selection of a Manning’s “n” value.

- USGS Roughness Characteristics of Natural Channels. http://pubs.usgs.gov/wsp/wsp_1849/pdf/wsp_1849.pdf
- FHWA Guide for Selecting Manning's Roughness Coefficients for Natural Channels and Floodplains. Water Supply Paper 2339. <http://www.fhwa.dot.gov/bridge/wsp2339.pdf>
- Water Resources Engineering, Mays, 2005

5.3.3 Freeze Protection Criteria

This section presents freeze protection criteria that are good practice and should be considered for most installations. However, this section is required for (1) all systems located in municipal rights-of-way and easements, (2) any system that is to be maintained by the MOA, and (3) any system installed for a private road with the potential to be owned or maintained by the MOA in the future.

- A. The minimum depth of cover over a gravity storm drain pipe without thaw protection is four feet and is measured from the street or ground surface to the top of the pipe. This does not apply to lift station force mains. Thaw protection for force mains is addressed in Section 5.3.10.
- B. Insulation is required for pipes with a diameter less than 30 inches if the depth of cover is less than four feet. If a storm drain pipe is located under a roadway structural section and insulation is included in the roadway section, additional insulation for the pipe is not required.
- C. Catch basins leads with less than four feet of cover may require insulation as determined by Street Maintenance.
- D. A thaw system is required if the depth of cover is less than three feet.
- E. When necessary, roadway culverts shall include provisions for thaw wire. See design requirements below.
- F. The use of steam thawing techniques requires the written approval of the MOA Maintenance and Operations Department.
- G. Oversizing of the outlet pipe may be used as a means of freeze protection if information demonstrating its effectiveness is provided.

5.3.4 Thaw Systems Criteria

This section thaw system criteria that are good practice and should be considered for most installations. However, this section is required for (1) all systems located in municipal rights-of-way and easements, (2) any system that is to be maintained by the MOA, and (3) any system installed for a private road with the potential to be owned or maintained by the MOA in the future.

- A. Many factors impact the need for a thaw system for storm drain piping. Several factors that should be considered are presented below. The designer is encouraged to contact Street Maintenance if it is not clear whether a storm drain thaw system is needed.
 1. Depth of cover -- Thaw systems are required for any storm drain pipe with less than three feet of cover.
 2. Design flow conditions – Slower velocity flow is generally more prone to freezing than higher velocity flow.
 3. Presence of base flow – If a storm drain pipe is anticipated to flow year-round, due to the

presence of base flow, a thaw system may be needed, even if the depth of cover requirement is met.

4. Pipe type and diameter – Generally, smaller pipe diameters are more prone to freezing than larger pipe diameters.
 5. Pipe location – Pipe freezing potential is impacted by the approximate depth of ground freeze. The ground freeze depth varies by location in Anchorage. Freeze depths tend to be significantly deeper if the pipe is located under an area that will be snow-plowed, such as a road or parking lot.
- B. Thaw systems shall include a thermostat and a Hand-Off-Auto switch.
 - C. The system shall have a minimum rating of 10 watts per foot and shall be self-regulating. Two wires may be used to meet the wattage requirements. In this case, place wires at 45 degrees left and right of the pipe invert.
 - D. Wire shall be 16 gauge copper bus wire with a polyolefin outer jacket.
 - E. Design of thaw systems is subject to review and approval by the local maintenance jurisdiction. For public projects located within the ARDSA, review and approval by Street Maintenance is required. For projects located within a RRSA or a LRSA, review and approval by the service area maintenance section or board is required.
 - F. All splices that may contact water shall be waterproof.
 - G. Thaw wire beginning and ending point shall be accessible to maintenance personnel.

5.3.5 Manhole Criteria

- A. A manhole shall be installed at major junctions, places where there are changes in vertical or horizontal alignment, and at locations where there are changes in pipe size or shape.
- B. Maximum manhole spacing is 300 feet because of MOA Maintenance and Operations Department pipe cleaning equipment limitations.
- C. Manholes within street ROWs are to be located in accordance with M.A.S.S. standard locations for new utilities.
- D. Manholes within storm drain easements are to be centered in the easement.
- E. Whenever possible, locate manholes outside of wheel paths.
- F. Depress manhole lids per M.A.S.S.
- G. Manhole lids shall not be located within the curb and gutter. This does not apply to catch-basin manholes configured specifically for curb placement.
- H. Catch basin manholes located in the curb and gutter shall be dual entry.
- I. The minimum invert elevation difference across a manhole is 0.05 feet.
- J. The absolute minimum inside manhole diameter is four feet. The designer shall refer to manhole standard details in the M.A.S.S. to determine minimum manhole size.
- K. A minimum 18-inch trap shall be provided on all manholes.

5.3.6 Culvert Criteria

Culverts are intended to safely pass flow under road crossings. Criteria are designed to protect, maintain, and enhance public health, safety, and the environment. Where culverts convey streams, additional standards are established to minimize impairment of stream functions and fish passage.

The minimum inside diameter of driveway and cross road culverts is 18 inches on MOA and DOT&PF streets except that within the MOA ROW, smaller diameter culverts may be allowed if it can be demonstrated that glaciation will not be a problem, the pipe will handle peak flows, pipe cover is adequate, and ditch depths are sufficient. Actual culvert sizing shall be based on the IDF Curves shown on Figure 4.2-1 and icing potential.

The minimum cover over a culvert is 12 inches. Culvert cover depth shall be based on an evaluation of traffic loads, culvert gauge thickness, material used for culvert fabrication, and glaciation potential. The crossing design must demonstrate that it can support the expected traffic loads without compromising structural integrity.

The following lists contain further culvert design information and criteria:

5.3.6.1 General Culvert Design Information

- A. Culvert ends shall be designed to minimize length and entrance and exit losses that lead to erosion at both the inlet and outlet ends with headwalls or flared end sections. Headwalls or flared end sections are required on all culvert ends.
- B. The minimum pipe slope is 0.5 percent. The slope shall be selected such that the velocity of the design flow causes neither siltation nor erosion.
- C. Culverts over 100 feet in length shall include access for maintenance through addition of manholes or other entry method subject to approval by Street Maintenance. Access shall be provided not less than every 100 feet.
- D. Driveway culverts in series shall be spaced at least 20 feet between each other.
- E. Non-stream culverts may have submerged inlets provided the following conditions are met:
 1. The total headwater depth at the inlet not to exceed 1.5 times the culvert diameter. For example, for a 18-inch culvert, the total depth at the inlet cannot exceed 27 inches.
 2. Roadway overtopping is not permitted at the design flow.
 3. The culvert shall include energy dissipation and erosion control measures immediately downstream of the outlet.
 4. The culvert shall be hydraulically designed with consideration given to the flow regime at the inlet, outlet, and inside the culvert barrel.
- F. Culvert slope shall be within 25 percent of the slope ratio (see Glossary).

5.3.6.2 Stream Crossing Culvert Criteria

- A. For stream crossing projects, consult with the appropriate state agency to determine fish presence. Alaska Statute Title 16 requires maintenance of fish passage. If the stream reach is determined to harbor fish, refer to fish passage criteria on the following page.

- B. Stream crossing culverts shall use erosion control measures, such as terracing, vegetation, headwalls, and grading to adjacent vegetated areas to reduce erosion into the stream from surrounding fill.
- C. Stream culverts shall be designed without submerged inlets at the design flow except in tidally influenced areas. Stream crossing culverts shall have a headwater depth to culvert height ratio of less than one.
- D. Stream crossing culverts on third order or higher streams shall be at least the width of the bankfull width of the channel (see Glossary).
- E. Stream crossing culverts on first and second order streams shall be designed to reduce glaciation potential. This can be achieved by maximizing cover and low flow stream depth, but must satisfy fish passage requirements (Section 5.3.6.3) if fish are determined to be present per the criteria on the following page.
- F. A single culvert for a stream's primary flow channel is required. (This requirement does not apply to floodplain "relief" culverts, as discussed below.) Under special circumstances, other design considerations, such as multiple stream channel culverts, can be considered but in these circumstances a bridge is the preferred option.
- G. Floodplain culverts, also known as relief culverts, shall be used as an alternative to obtain required design flow capacity while maintaining creek dimensions and reducing glaciation potential.
- H. Stream culverts shall be designed to be aligned as closely as possible with the natural alignment of the stream channel in order to minimize backwater effects from flood events and potential blockages.
- I. Peak flows used to size stream crossing culverts shall be designed in accordance with applicable stormwater management requirements.
- J. The potential for erosion at culvert outlets shall be evaluated and appropriate treatment provided in the design. Such treatment measures shall not impede fish passage or trap debris during flood events.

5.3.6.3 Fish Passage Criteria

- A. Determination of fish presence is required for all stream crossings. The designer shall refer to MOA Stream Reach Maps to determine if a waterway is listed as a stream, and contact the appropriate state agency to determine whether fish are present. In addition, culvert design shall conform to the regulatory requirements of Alaska Statutes Title 16 Fish and Game.
- B. Within the MOA, there are two main methods of designing for fish passage: the stream simulation method and the hydraulic method. Generally, the stream simulation method shall be the primary method applied to stream crossing culverts where fish passage is required except as noted in this section.
- C. All culverts less than 100 feet long in streams with less than six percent slope shall be designed using stream simulation method criteria. Stream simulation will be the preferred design alternative in streams up to six percent slope.
- D. In cases where the stream simulation method is desired for lengths greater than 100 feet, the design must meet state requirements for a fish passage permit under Alaska Statutes Title 16. Site-specific evaluation is necessary because over 100 feet, the effects of culvert length on streambed stability and configuration are not yet sufficiently understood.

- E. Stream channel slopes greater than six percent shall require additional stability analyses for authorization of using the stream simulation method. Culvert design methods such as hydraulic, zero-slope, or other design options shall be authorized when site-specific conditions preclude use of the stream simulation method.

Both fish passage design methods are discussed in greater detail in the sections below.

Stream Simulation Method

Stream simulation methods of culvert design at road crossings emulate the natural functions and physical conditions within the stream channel of a stream, facilitating sediment transport, fish passage and reducing glaciation issues in some cases. The intent is to mimic the local stream features so that the crossing represents no more of a fish and debris passage challenge than the natural channel itself, while satisfying other road crossing design criteria. Information on this methodology is available at Alaska Department of Fish and Game (www.adfg.alaska.gov/index.cfm?adfg=uselicence.culverts) and at the USDA Forest Service (<http://www.stream.fs.fed.us/fishxing/>).

All stream simulation designs and methodologies must comply with the following criteria:

- A. Culvert slope shall approximate the stream slope through the reach in which it is being installed or appropriate reference reach (see Glossary). The slope ratio (see Glossary) shall not vary more than 25 percent to minimize adverse effects on channel conditions.
- B. Stream crossing culverts on third order or higher streams shall be at least as wide as the product of 1.2 times the bankfull channel width, but may be subject to limitations due to cover requirements.
- C. Stream crossing culverts on first and second order streams shall be at least as wide as the bankfull channel width, rounded to the nearest foot.
- D. Culverts shall be embedded over the entire length with streambed material of sufficient depth to withstand maximum scouring at the design flow or shall be embedded at least 40 percent of the culvert diameter for round culverts and 20 percent of the maximum height in pipe arch culverts.
- E. Substrate material will be designed for at least two flow conditions:
1. Streambed material shall be sized to be dynamically stable to at least the 50-year event and mimic the natural streambed material within this stability requirement.
 2. Streambed material shall maintain the natural low flow and depth of the reach as surface flow unless the reach is documented to naturally go dry during low flow periods under normal hydrologic and climatic fluctuations.
- F. The cross-section shall simulate an appropriate reference stream channel cross-section and shall be designed to be dynamically stable at the design flow. Channel sides can be continuous or rockbands utilized as necessary to maintain channel shape. Continuous channel sides are required to reduce glaciation potential. In other cases, rockbands can be utilized, provided they are spaced the lesser of either five times the width of channel or such that the maximum vertical difference between crests is less than 0.8 feet.

Hydraulic Method

The hydraulic method uses the swimming capability and migration timing of target design species and sizes of fish to create favorable hydraulic conditions throughout the culvert crossing. Information on this methodology is available at Alaska Fish and Game Sport Fish Division (www.adfg.alaska.gov/index.cfm?adfg=uselicense.culverts), the Federal Highway Administration (<http://www.fhwa.dot.gov>), and the USDA Forest Service Stream Systems Technology Center (<http://www.stream.fs.fed.us/fishxing/>).

- A. The design fish shall be a 55 mm (2.16 in) juvenile Coho salmon for anadromous streams and a 55 mm (2.16 in) Dolly Varden char for nonanadromous streams. These criteria may change based on ongoing research by federal and state agencies.
- B. Fish passage high flow design discharge will not exceed the five percent annual exceedance flow or 0.4 times the 2-year peak flow, whichever is lower and has the most supporting hydrologic data.
- C. Fish passage low flow design discharge shall ensure a minimum six-inch water depth or natural low flow and depth within the reach the crossing occurs. In cases where local conditions preclude natural low flow characteristics, backwatering or in-culvert structures shall be considered.
- D. In cases where flared end sections with aprons are necessary and fish passage is required, water depths and velocities that satisfy fish passage criteria must be demonstrated across the apron in addition to within the culvert.

Fish passage criteria for all culvert design options must be satisfied 90 percent of the time during the migration season for the design species and age class pursuant to Alaska Statute 41.14.840. Tidally-influenced streams may sometimes be impassable due to insufficient depth at low flow and low tide. If the tidal area immediately downstream of a culvert is impassable for fish at low tide, the 5 percent exceedance criterion shall apply only to the time during which fish can swim to the culvert. Tidally-influenced fish passage structures shall satisfy Alaska Statute 41.14.840 for an average of at least 90 percent of the tidal cycles, excluding periods when the stream channel is not accessible to fish because of natural conditions at low tide.

5.3.6.4 In-Water Work Criteria

In-Water work projects include stream, off-channel, and riparian restoration and rehabilitation, streambank stabilization, and installation of outlet and diversion structures.

In-water design should include provisions for the following:

- A. Maintenance of active flood plain capacity
- B. Design Considerations for sediment and erosion control within the waterbody including long-term bed and bank protection, and
- C. Long term icing controls.

5.3.7 Subdrain Criteria

- A. Subsurface flow volumes are estimated by using the water table elevation, the depth from the water table elevation to the subdrain invert, and the hydraulic conductivity of the soil.
- B. The need for subdrains to collect and transport subsurface waters is determined by the designer.

Storm drain pipes may be perforated to collect subsurface drainage as a secondary function.

- C. The diameter of subdrain pipe will be determined using Manning's equation and the appropriate Manning's n value (Table 5.3-1) or other generally accepted engineering practice. Conventional subdrains for use in municipal conveyance systems or ROW shall not be less than 10-inches in diameter.
- D. Subdrains are to be constructed of perforated pipe surrounded by filter material. Geotextile fabric shall be placed around the filter material; however, wrapping geotextile fabric directly around the pipe is not acceptable.
- E. Private Development requirements for subdrains and sump pumps is addressed in Handout Administrative Guideline (AG) 20 (Sump Pump Discharge Requirements) and Policy AG 26 (Interim Drainage Guidelines).
- F. For subdrains within municipal conveyance systems or ROW, subdrain pipes shall begin and terminate in a manhole. Cleanouts are not permitted for this use.
- G. Subdrain outfalls to surface drainage shall include an outlet screen or flap gate to prevent animals from entering the pipe.
- H. Evaluation of the possible nature and extent of contaminated groundwater in the area of the subdrain and its possible collection by the subdrain must be completed as part of the subdrain design.
- I. Subdrains or curtain drains which serve parcels with on-site sewer systems shall not be permitted to drain directly into drainage pipes, ditches, or swales, unless it can be clearly demonstrated that there are no related health hazards.

5.3.8 Cleanout Criteria

- A. Due to the difficulty in cleaning and thawing storm drain cleanouts, cleanouts are prohibited for use within municipal rights of way or as part of public conveyance systems. Manholes are required as the terminus for subdrains in these cases.
- B. Cleanouts on private sites shall be configured and spaced such that the facility can be properly maintained.
- C. The minimum cleanout pipe diameter is 12 inches. A cleanout shall connect to the existing storm drain or subdrain pipe with an adaptor as shown in M.A.S.S.

5.3.9 Outfall Criteria

- A. Flared end sections or headwalls are required on all storm outfalls.
- B. The invert elevation of a storm drain or subdrain outfall shall be the highest of the following:
 1. The one foot above the ordinary high water surface elevation of lakes and ponds,
 2. One foot above the 100-year water surface elevation for regulated streams,
 3. One foot above the bankfull water surface elevation for non-regulated streams, or
 4. The highest elevation practical based on high water and the incoming pipe slope.

This is to provide storage for ice accumulations, discourage fish passage and prevent blockages of outfalls due to storm flows.

- C. Drainage outfalls or spillways to natural ground from curbs and gutters, pavements, drainage swales, ditches, or other drainageways shall be designed and constructed to provide positive drainage, prevent ponding within the ROW, and to create or cause no impacts on adjoining property (or properties). Drainage outfalls or spillways shall be designed and constructed to achieve a minimum fall of 2.5 feet to the natural ground surface. (See figure below.) The outfall or spillway shall have a slope no flatter than 3:1 (horizontal : vertical) and no steeper than 2:1. Drainage outfalls or spillways shall be protected with appropriate energy dissipation, erosion control measures, and protection against icing.

Figure 5.3-1 Outfall to Natural Ground

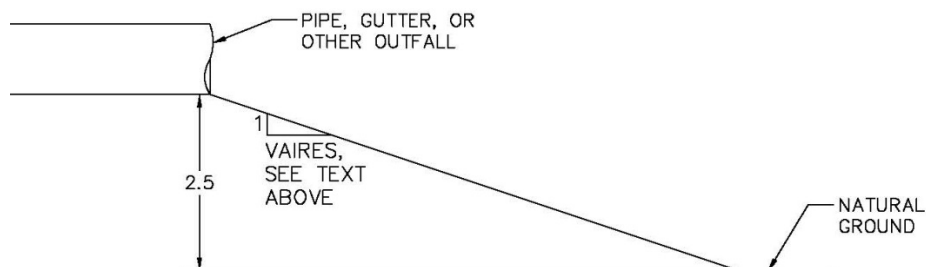

- D. Provision for an electric source is required for all storm drain outfalls where thaw wire systems are installed. A standard detail for a meter base is provided in M.A.S.S. The designer shall prepare and submit an application for service to the utility providing the electricity. The contractor is responsible for hookup after construction as outlined in M.A.S.S.
- E. Discharge permits shall be obtained from the appropriate agencies for all new storm drain outfalls.
- F. Grates on outfalls are an important safety consideration. Grates with an opening no more than four inches are required on outfalls 12 inches or larger. Grates shall be equipped with security bolting to allow appropriate maintenance and prevent/minimize vandalism. Grates shall be either hinged or removable for maintenance access.
- G. See Section 6.8 for energy dissipation design criteria.

5.3.10 Lift Station Criteria

5.3.10.1 General

- A. The use of storm water lift stations is considered to be the solution of last resort and must be approved in writing by the Municipal Engineer.
- B. Lift station design and construction shall conform to the latest edition of M.A.S.S. and all work shall be in accordance with International Building Code, International Mechanical Code, Uniform Plumbing Code, National Electric Code (NEC), and National Fire Protection Association, all as revised, accepted, and adopted by the MOA.
- C. Lift stations shall be accessible by maintenance personnel year round on roads or trails capable of accommodating H-20 traffic loading and readily traversable by maintenance vehicles. Where the lift station is not located in or immediately adjacent to a developed roadway, a gravel pad of sufficient size to accommodate all lift station components and maintenance operations shall be provided. No lift station shall be located in a ditch or within a snow storage area.

- D. Access hatches for lift stations within roadways shall be located outside the travel way if possible.
- E. Suitable and safe means of access shall be provided into all dry wells, wet wells, and vaults containing mechanical or electrical equipment requiring maintenance. All controls, sensors and pumps shall be removable without entering the wet well, dewatering, or disconnecting any piping on any station where this equipment is submerged in the wet well.
- F. All equipment within a lift station must be serviceable, removable, and replaceable through the provided access ways.
- G. Unless site constraints can be demonstrated, isolation and check valves for each pump shall be located outside the wet well in a separate vault.

5.3.10.2 Pumps/Wet Well Criteria

- A. Lift stations shall utilize centrifugal pumps. Each lift station shall have two pumps. Justification for a three pump systems will need approval from the Municipal Engineer. One spare pump of each size installed shall be provided to Street Maintenance as a spare on MOA maintained stations. Variable speed pumps may be used to accommodate design flows and to minimize size of the wet well.
- B. The lift station wet well and pump capacity shall be sufficient to:
 - 1. Accommodate the design year storm event (see Table 4.2-1), without surcharging the wet well inlet pipe.
 - 2. Accommodate the 5-year design event without surcharging the inlet pipe with any one pump non-operational.
- C. For private lift stations discharging into Municipal storm drains, maximum discharge flows shall be limited per the requirements of Section 3 of this manual.

Wet wells:

- A. Wet wells shall be constructed of poured in place or precast concrete; or prefabricated from fiberglass. Steel wet wells shall not be used. Precast concrete wet wells shall include exterior joint waterproofing membrane in addition to the gasket material between sections. Poured in place concrete wet wells shall utilize waterstop materials at all construction joints.
- B. The wet well and other vaults shall be completely ballasted against flotation under flood conditions.
- C. The wet well shall be sized to limit motor starts to not more than 6 starts per hour per pump.
- D. The wet well shall be designed with a sump, baffle wall or other accommodation for collection of rocks and stones. In general, wet well sumps shall be designed to avoid directing debris into pump intakes.
- E. Wet well and vault covers shall be of a suitable material, design and construction for the station installation as required to accommodate imposed loads and as required to protect the lift station and the public. Station covers shall accommodate H-20 traffic loading unless the cover is at least 30 inches above finish grade. All station covers located within or adjacent to roadways surfaces, sidewalks, trails, etc, shall accommodate H-20 traffic loading.

Pumps:

- A. May be submerged within a wet well, or located within a dry pit. Where pumps are located within

a dry pit, the pit shall be completely protected from flooding. Alternatively, submersible pumps shall be installed in the dry pit.

- B. Whenever possible, pumps shall be three-phase. All pumps 5-horsepower and larger shall be three-phase. Where three-phase power is not available, and pumps 5-horsepower or larger are required, a frequency inverter drive unit shall be provided to synthesize the third phase.
- C. When required by the electrical utility, solid state reduced voltage current-limiting motor starters (soft starts) shall be provided to limit electrical starting loads.
- D. Pumps shall be capable of passing spheres at least 3-inches in diameter. Station piping shall be at least 4-inches in diameter. Use of smaller pumps or piping requires the written approval of the Municipal Engineer. Pumps shall be self-priming or flooded suction type.
- E. Each pump shall have an individual intake.
- F. Where only two pumps are provided, they shall have the same capacity. Where more than two pumps are provided, they shall be designed to fit the actual flow conditions, such that with the largest unit out of service, the remaining pumps have adequate capacity as specified herein.
- G. Pumps shall be Underwriters Laboratories and/or Factory Mutual approved for the NEC hazardous area classification they are installed within. In general, submersible pumps installed within a wet well shall be rated explosion proof for use within a NEC Class I, Division I/II Hazard Area.

Valves:

- A. Isolation valves and check valves shall be provided for each pump.
- B. Non-clog ball-style check valves may be installed vertically in the wet well of submersible pump lift stations. All other styles of check valve shall be installed horizontally in a vault or other accessible location above the wet well liquid level during normal operations.
- C. Isolation valves shall be plug, gate, or butterfly valves as determined by size of the pump. Valves of appropriate design may be buried provided they are equipped with suitable valve boxes and operating nuts. Operators shall be provided for all valves installed within vaults.
- D. Isolation valves shall be provided on the suction line of each pump in a dry pit installation.

Ventilation:

- A. Wet wells shall be passively ventilated via schedule 40 steel gooseneck vent pipe with bird screen.
- B. Where pumps are installed in a dry well, mechanical ventilation and humidity control shall be provided.

Controls/Electrical:

- A. Programmable Controls shall provide for manual and automatic operation of pumps, generating alarms and controlling other equipment provided. Controls shall include:
 - 1. Circuit breakers and lockable disconnects as required.
 - 2. Pump controller shall provide LEAD / LAG operation with automatic alternation and the ability to select which pump is to operate in LEAD.
 - 3. The pump controller shall allow for easy adjustment of all pump and alarm operating points.
 - 4. HAND/OFF/AUTO switches for each pump.
 - 5. Pump run time monitors for each pump, and one for two pumps and three pumps running

- together as appropriate.
6. Indicator lights for pump and alarm status.
 7. Alarm light annunciators.
 8. Panel heater with adjustable thermostat as appropriate.
 9. Transient voltage surge suppressor.
 10. Phase converters and/or variable frequency drive units, where required, may be integral to the control panel, or remotely mounted units. Phase converters shall be solid state. Rotary converters shall not be used.
 11. Convenience features such as ground fault circuit interrupter receptacles and panel lights as specified by the Municipal Engineer.
 12. Other items as required for proper lift station function.
- B. Control enclosures shall be National Electrical Manufacturers Association (NEMA) 4X, as determined by weather exposure. The enclosure shall have a lockable exterior door, and an interior dead front with safety interlocks on the main circuit breaker. All user controls and indicators shall be mounted on the dead front such that they are operable without exposing the user to hazardous voltages.
- C. All equipment installed within the wet well shall be rated for use within a NEC Class I Division I/II Hazard Area, and/or listed as intrinsically safe.
- D. Control enclosures shall be located outside of the NEC Class I Division I/II hazardous location boundary, and shall be separated from the hazardous area by appropriate conduit seals and construction. Appropriately rated junction boxes shall be provided within the wet well for control and power cables termination to allow equipment to be removed and replaced without disturbing the conduit seals.
- E. Transducers shall be solid state, floats designed to be resistant to fouling shall be used for extreme HIGH level only. In all cases, the transducers shall be capable of calibration and/or adjustment and capable of replacement without entering the wet well. In all cases, a float shall be provided for a redundant high level alarm.
- F. Visual alarms shall be provided at all lift stations. Alarm signals annunciated at the panel shall include as a minimum:
1. Power failure
 2. Pump failure (both thermal and seal failures)
 3. High level alarm
 4. Low level alarm (i.e. pump shut off failure)
 5. Transient voltage surge suppressor failure
 6. Phase loss/phase converter failure
 7. Temperature (freeze) alarm
- G. Automatic Dialer with battery backup shall be provided. Dialer shall be capable to be programmed to:

1. dial sequential numbers until answered
2. Identify Lift station
3. Annunciate up to 8 specific alarms

Force mains:

- A. Force mains shall be high-density polyethylene, Size Dimension Ratio 17 pipe and fittings or greater where required by operating pressure. Ductile iron pipe or steel pipe may be used for station piping provided suitable corrosion protection is provided. All piping and fittings shall be designed to resist pipe thrust and water hammer conditions.
- B. Whenever possible, the force main shall be sloped downward such that the force main drains completely between pumping cycles.
- C. The force main shall be designed with consideration for elimination of or control of entrapped air. Combination air release/vacuum valves shall be installed within access vaults at points of grade reversal which may trap air.
- D. The force main shall be sized to maintain a minimum of at least 3 fps flow velocity within the force main during average operating conditions.
- E. Appropriate energy dissipaters shall be provided at the outlet of the force main.
- F. The force main shall be pressure tested to 150 percent of the pipe design pressure.

Freeze Protection

- A. Freeze protection shall be provided using insulation and/or heat tracing. Degree of freeze protection required varies with depth of the lift station. As a minimum, the lift station structure, lid, and access hatch shall be insulated to the expected frost depth.
- B. All force mains shall be protected from freezing with insulation, heat tracing, or sufficient depth of cover. Where the force main or discharge piping remains full and does not drain freely, both heat trace and insulation shall be provided unless thermal analysis is provided demonstrating that insulation or depth of cover alone will prevent freezing.

5.4 Drainage Criteria for Streets

5.4.1 Curbs and Gutters

In urban areas, curbs and gutters are usually required to pick up drainage from streets and adjacent properties. Curb and gutter design guidelines and types are discussed in the DCM. For flexibility with stormwater management design options, curb is not required to be continuous.

5.4.2 Ditches

In rural areas, roadside ditches usually pick up drainage from streets and adjacent properties. Standards for ditches are provided in Section 5.5.

5.4.3 Storm Drain Inlets

Inlet spacing shall be designed for the following criteria:

- A. No more than 20 to 25 percent of the gutter flow reaching each inlet will pass on to the next inlet downstream and in accordance with 5.4.5.
- B. Inlet spacing design requires engineering calculations showing a tabulation of inlet capacity compared to design flow. If computations do not clearly demonstrate adequate inlet capacity, additional inlets may be required. FHWA's HEC-22 manual outlines computation methods for various types of inlets and roadway configurations.
- C. In all cases, the maximum spacing between inlets shall not exceed 1,100 feet.
- D. At intersections where storm drains are available, catch basins shall be used instead of valley gutters. In unpaved areas, the placement of an asphalt or concrete pad that slopes toward the inlet is required. The asphalt pad shall extend at least 2.5 feet from the outside edge of the inlet to the outside of the pad.

Inlet spacing evaluation shall also include:

- A. The flow velocity on street grades over five percent.
- B. Evaluation of the effects of 50 percent of the inlet opening being obstructed (such as by trash, debris, and leaves).
- C. Consideration of amount of water and corresponding length of roadway being directed across curb ramps. Significant quantities of water should not be directed across a curb ramp, as this restricts the use of the ramp and causes unnecessary ponding.
- D. Consideration of the roadway grades and cross slopes at intersections. At intersections where one or both roads are at a significant grade, care should be taken to ensure that water flowing in curbs does not exit the curb and flow into the intersection, particularly at curb returns. Inlets upstream of curb returns may be required.
- E. For roadways with slopes less than 1%, the designer should consider decreased inlet spacing to minimize localized ponding due to irregular slopes after construction.

5.4.4 Valley Gutters

Valley gutters shall be provided to carry drainage through street intersections and across commercial driveways where it is impractical to intercept the drainage with a storm drain inlet. Valley gutters shall be asphalt concrete construction. The use of portland cement concrete valley gutters is prohibited. The minimum grade for a valley gutter is one percent.

5.4.5 Pavement Encroachment

- A. No curb overtopping on residential streets shall occur during the 10-year design storm event.
- B. The maximum acceptable drainage encroachment for the 10-year design storm event on primary streets is to not allow curb overtopping and to maintain at least one driving lane in each direction free of water.
- C. Surface drainage encroachment is not allowed on any traffic lane of a freeway or expressway.
- D. The maximum acceptable drainage encroachment on paved alleyways is containment of water within the alley ROW.

5.4.6 Subsurface Drainage Control

Fin drains or other subsurface drainage controls, including controls to prevent icing, shall be used where conditions warrant. Controls for icing are discussed in Section 5.8.

5.5 Open Channels

5.5.1 General

Open channels, including streams, drainageways, and water quality facilities are generally encouraged when they are:

- A. A conveyor of water from a stream or natural drainage,
- B. A temporary channel as part of a phased drainage project that will be replaced with pipe as full drainage improvements are developed,
- C. A road ditch for a rural street section, and
- D. A component of a water quality improvement.

5.5.2 Design Methods

- A. For situations that involve re-routing or re-aligning existing streams, see Section 5.7.
- B. Any temporary open ditch shall be designed to contain the design flow of the proposed permanent pipe system specified in Table 4.2-1.
- C. The capacity of a roadside ditch used for stormwater conveyance shall be based on the appropriate design storm event specified in Table 4.2-1 with a minimum channel freeboard of one-foot.
- D. The design storm shall be used to evaluate the need for erosion control measures.

- E. For conveyance channels that are not intended to provide stormwater treatment, the minimum allowable slope is 0.5%. Note that this does not apply to treatment facilities such as vegetated swales, bioswales, landscaped depressions, etc.
- F. Open channels are designed using Manning's "n" values in Table 5.3-1 based on expected mature growth conditions of the channel 10 years after construction.
- G. When the channel is part of a water quality improvement, the minimum channel capacity shall be the same as the capacity of the water quality facility.
- H. The final profile of constructed channel segments shall reflect the natural character of the profile of undisturbed channel segments immediately upstream and downstream of the re-routed or re-aligned segment of the stream. Transitions between constructed and undisturbed channel segments shall be gradual, and constructed in a manner that does not induce erosion or sedimentation.

5.5.3 Side Slopes

Channel side slopes shall be no steeper than 2:1 except in streams as discussed in Section 5.7. Erosion control is required in accordance with Sections 5.6 and 6.8.

5.5.4 Flow Velocity

The maximum flow velocity in a channel shall be such that no erosion or scouring will occur to the channel sides or bottom for flows up to, and including, the design storm flow. Guidance for channel erosion control design is provided in Section 5.6. Check dam criteria are included in Section 6.8.

5.6 Channel Erosion Control Design

Watercourse open channel erosion stability analysis and design shall be generally performed as described in the Federal Highway Administration's (FHWA) hydraulic engineering circulars and design manuals. Guidance for general analysis and design of open channel flow resistance shall be as described in FHWA Hydraulic Engineering Circular 22, 3rd edition (Brown, et al 2009). Flow resistance design for open channels where slopes exceed 10 percent and for composite linings shall conform to guidance in FHWA Hydraulic Engineering Circular 15 (Kilgore and Cotton, 3rd edition, 2005).

Erosion stability and channel design shall at minimum calculate, tabulate and report for representative sections and lining characteristics at peak flow of the design storm for the following items:

- A. Maximum shear stress;
- B. Shear stress in critical bends;
- C. Side slope stability for channels with side slopes steeper than 3:1;
- D. Permissible or critical shear stress for proposed channel lining or armor;
- E. General shape of rock substrate (e.g. rounded rock tends to be more easily mobilized than angular rock.)
- F. Gradation of the rock substrate; and
- G. Effective Manning's "n" and transitional lining characteristics for composite channel linings,

particularly where low flow channels are required (e.g., for low base-flow streams and other perennial flows subject to icing).

For all channel erosion stability calculations, reports shall tabulate design parameters used including at minimum (1) peak flow rate and velocity for the design storm peak, (2) channel profile and cross section geometry, (3) channel slope, (4) channel roughness, and (5) proposed or existing channel side and bottom lining material type and size, and as necessary for each composite and transitional lining material type.

5.7 Stream Restoration

Streams function as fish and wildlife habitat, flood attenuating drainageways, and natural greenbelts in developed areas. Construction in streams must consider these factors. This section provides additional design criteria for this work. In addition to this section, designers should be familiar with the requirements of the Corps of Engineers and the Alaska Department of Fish and Game.

Hydrology/Hydraulics:

- A. Floodplain design discharges shall be selected in accordance with Federal Emergency Management Administration (FEMA) regulations, or the maximum recorded flood flow, whichever is greater.
- B. The restored main channel design discharge shall be the 2-year recurrence interval flood, unless otherwise approved by the Municipal Engineer.
- C. The shape of the restored main channel shall be consistent with the shape of undisturbed channel reaches immediately upstream and downstream of the constructed channel.
- D. Average summer flows shall be identified for use in the evaluation of fish habitat.
- E. The channel improvements shall not extend the 100-year floodplain limits.

Stream Channel Alignment:

Selection of the stream alignment shall incorporate the following considerations:

- A. Match the original alignment of the stream when possible.
- B. Match the original length when the original alignment is known but the restored channel is unable to follow it. The alignment of the stream channel shall be such that the length of the restored channel is approximately equal to the original length of the natural stream channel.
- C. Match a natural gradient when the original alignment is unknown. Compute the length of channel using the slope of undisturbed reaches immediately upstream and downstream of the project site, and the elevation drop through the site.
- D. Select an alignment and a gradient that alleviates defined problems such as glaciation and flooding, and enhances wildlife habitat.
- E. The longitudinal profile of the restored stream bed shall be similar to the existing profiles upstream and downstream of the reach being designed.
- F. Sharp bends shall be removed from the alignment whenever possible.
- G. The alignment of a restored and/or reconstructed floodplain may be relatively straight but the restored main channel shall meander within the floodplain.

- A. Locate the restored stream channel adjacent to undisturbed vegetated areas whenever possible. Construction equipment may be confined to the excavated channel or previously disturbed areas to avoid disturbing naturally vegetated areas.

Erosion Control and Bank Protection:

- A. Erosion control and bank protection shall be provided whenever work is performed in or adjacent to a stream.
- B. The design of stream alignment or grade change improvements shall include a hydraulic and hydrologic analysis to determine the need for erosion control and/or bank protection.
- C. Where stream bank stability is critical, riprap in conjunction with bioengineered vegetative erosion control above the ordinary high water line is the recommended method for stream channel protection.
- D. In areas where bank stability is not critical, bioengineering methods such as fascines, coir logs, brush layering, and other methods incorporating vegetative materials shall be considered. The use of riprap without the incorporation of vegetative materials is discouraged.
- E. The recommended floodplain protection method is the planting of grass and natural woody vegetation.
- F. MOA maintenance personnel shall be allowed access to the stream during construction activities.

Stream Channels:

The design of restored stream channels shall consider the undisturbed, predevelopment conditions of the stream. In-stream structures that are constructed solely for the creation of habitat shall be designed so that changes in local stream hydraulics do not cause bed scour, bank erosion, or deposition in the vicinity of the habitat feature as the stream adjusts its configuration. Habitat features designed for use in areas with bed or bank protection shall be designed with caution since the desired natural readjustment in the cross-section may be inhibited by the presence of the protection structures. Stream channels shall be designed using the following guidelines:

- A. Identify a reference reach or most likely pre-development condition of the stream channel. Identification is subject to approval by the Municipal Engineer.
- B. Design channel to mimic the stream geomorphology of the approved reference reach or undisturbed, pre-development condition.

Riparian Habitat Enhancement and Floodplain Construction:

The purpose of providing riparian habitat enhancement and a floodplain along a restored reach of stream is to create habitat diversity for fish and wildlife, and provide natural flooding characteristics in the stream valley. Riparian vegetation provides shade, cover, and insect food sources for fish, and food, resting, and nesting sources for wildlife.

A floodplain bench shall be constructed at an elevation corresponding to the level of the two-year recurrence interval flood. The bench shall be revegetated as described in the subsection below to provide the desired riparian habitat.

Restored and/or reconstructed floodplain side slopes above the two-year recurrence interval flood level shall be no steeper than 2:1 and shall be roughened prior to revegetation.

Restored and/or reconstructed floodplains shall be designed to accommodate, at a minimum, the 100-year recurrence interval flood. Intermediate floodplain benches that are designed to accommodate the 25-year flood may be incorporated as appropriate.

Revegetation:

The purpose of revegetation in stream restoration projects is to provide a filter for surface flow to the stream, provide stream bank stability, and to provide fish and wildlife habitat. Revegetation in the riparian zone (frequently flooded zone adjacent to the stream channel) and inactive floodplain (infrequently flooded zone adjacent to the riparian zone) shall be accomplished in a way that:

- A. Reduces erosion and stabilizes stream banks and side slopes;
- B. Provides protective cover for fish;
- C. Traps sediment and other pollutants;
- D. Provides nutrients to streams;
- E. Supports growth of aquatic insects that are eaten by fish;
- F. Aids in water recharge of streams during low flow periods;
- G. Provides wildlife habitat; and
- H. Supports recreation such as fishing, bird watching, nature study, and photography.

In addition, the following recommendations should be followed:

- C. Revegetation plans shall be developed concurrently with design.
- D. Side slopes shall be contoured to slopes no steeper than 2:1. Benches included on the side slopes shall:
 - 4. Intercept surface flow on side slopes;
 - 5. Provide a stable surface for revegetation; and
 - 6. Distribute flow over a wider area to reduce scour potential.
- E. Side slopes and benches shall be roughened prior to revegetation to create small pockets, which provide a more favorable growing environment for plants.
- F. Ground cover and/or seedlings shall be planted on side slopes to reduce erosion. No seedlings shall be planted below the elevation of the 2-year recurrence interval flood in the channel.
- G. Large, woody plants shall be planted on benches to establish a root mass that will stabilize the stream bank (see the DCM Chapter 3, and Appendix E of this manual for plant selection details).
- H. Maintenance includes frequently checking the revegetated side slopes and benches until the vegetation becomes established and to identify and stop any localized erosion that may develop. Fertilizer may be used provided water quality impacts are addressed.

5.8 Icing Control Design

Design for control of winter icing of perennial surface flows is a critical element in design of any surface water conveyance in the Anchorage region. Adequate design for winter icing control for small streams and open channel stormwater conveyances will often require separate analyses for flood conveyance and

icing control.

Considerable professional literature exists for design of stream icing controls but, unfortunately, much of this literature is focused on larger rivers where design failures carry larger, community-wide risks. Quantitative design guidance for small streams and open channels is less readily available. However, some elements are basic to design for almost all small structures and are summarized below.

Channel Profile:

Small stream and drainageway channelization often negatively impact the thermal regime of these features by increasing the grade. This promotes super cooling by increasing the surface area of water directly exposed to the atmosphere and increasing the rate of cooling. This removes and limits vegetation and snow and ice insulation, thus further increasing the rate of heat loss. Winter icings in small flows are often promoted where turbulent shallow flow enters sharp grade breaks, particularly where horizontal bends or projections create eddies or structures immediately downstream that can accumulate frazil ice.

Good icing control requires design for short-period, alternating pool/riffle (low slope) or plunge pool/step structures (steep slope), large-radius horizontal and vertical bends, and profile grades that do not significantly exceed that of local natural streams. Generally the period in the profile (the length of one pool/riffle or pool/step feature) can be made to match natural conditions observed up- and downstream but, in general, the overall length of a single series should not exceed about seven to 10 times the bankfull-width of the channel, with riffles or steps being about 1/5 to 1/6 the length of their adjoining pools. Steps and riffles should also be constricted in width relative to pool structures to help minimize turbulence and maximize depth during low-flow periods.

Channel Section:

For icing control of small flows, low-flow channel structures having small width to depth ratios (about 2:1 (H:V) or smaller) at bankfull conditions are required. For design purposes, width at bankfull flow should be estimated for peak flow rates occurring during the 1.5- to 2-year return period runoff event at a riffle section. Constructing and maintaining a small width-to-depth ratio for a low-flow channel while providing for adequate bank vegetation (for thermal and erosion protection) and meeting other profile and section design requirements can be difficult.

Use of silt socks to stabilize banks can provide economical, simple and very effective solutions to these low-flow channel design requirements. Silt socks should be used in combination with (1) gravel and rock sized for stability at larger flows and for channel bedding, and (2) occasional use of large, stable rocks for steps on steeper slopes and to occasionally direct flows. The silt socks can be readily shaped to the desired channel form and planted with appropriate vegetation to provide thermal protection at low flow conditions as well as resist channel erosion from large flood flows. Where channels will carry flood flows much larger than the anticipated low-flows, a composite channel section may be required to support both flow regimes. Thermally-protective low flow channels will still be required but will be set within a larger flood flow channel constructed to safely carry the design flood flow.

Protective Vegetation:

Provision of bank vegetation and near-channel structures that will provide thermal protection and support an insulating snow and ice cover during low flows is critical to small channel icing designs. Brush planted at the immediate bankfull margin that is large enough at maturity to arch over a substantial fraction of

the low-flow channel serves to inhibit air movement across the stream surface and capture snow as an insulating layer. Once established, brush will also provide excellent erosion protection and alternate flow paths for small channel structures. Brush, as a thermal design element, should be placed immediately adjacent to both sides of the low-flow channel and as continuously as possible along the entire channel.

Short reaches may be left open as stream access points and for aesthetic viewing purposes but these openings should be short, generally not exceed more than about 10 to 20 percent of the total bank length, and expose only one side of the stream. Small rocks sized to be immobile at larger flood events and embedded periodically in the bed at the margins of pool structures can also help support development of an insulating ice cover early in the winter. However, these rocks should not be so abundant or placed so as to increase mid-channel turbulence or promote large eddies or lateral flow.

Subsurface Flow and Crossings:

Most heat loss impacts to small stream flows can be significantly mitigated by simply re-routing surface flows through subsurface conduits (most effectively done as laminar flow in pipes or as tortuous flow in thick, coarse rock aggregate). Obviously if surface flow is desirable (as is frequently the case for small stream features) this is not an acceptable alternative. On the other hand, channelization and open bridging of very small flows, say for pathways or driveway crossings, can hugely exacerbate icing development through channel (flow surface) widening, local grade and turbulence increases, adjacent insulating vegetation and snow cover removal or prevention, cold air funneling, and shadowing. In these circumstances, smooth-bore culverts shall be graded to the bed of the up- and downstream channel, appropriately insulated across their arch by thicker fill or board insulation, and constructed to as short a length as possible. Smooth-bore culverts are preferable to open bridges, particularly wider bridges on wider, more-exposed rights-of-way. In some cases, washed rock bedding extending up- and downstream of the culvert inlet and outlet may still be necessary to prevent icings where the other icing design elements are limited or less effective.

Maintenance:

Even the most-protected or carefully-designed low-flow channel can be exposed to an increased icing potential by poor maintenance practices. Channel maintenance done to improve flood flow performance along winter low-flow features can dramatically increase icing development where it includes periodic channel widening and vegetation removal (particularly where vegetation is removed along the immediate stream bank). Similarly side-casting snow into channels can reduce or destroy insulating cover and increase potential for development of icings. This practice can be quite common at driveway crossings and is not unusual along rural roadways where many small streams have been routed into the roadside ditches. It is not much less common for earthen fill or other obstructions to be placed across intermittent streams and drainageways as well, particularly where local residents are not well aware of the seasonal functionality of these types of features.

Some emergency mitigation practices of stream icings can actually increase icing severity. Excavating icings from a channel often simply re-exposes small flows to optimum channel conditions for re-development of the icings. The best short-term seasonal fixes include creating (usually with low-pressure steam hoses) very narrow, deep channels in the existing icings (occasionally protected by application of an arching cover of protective dry straw or other woody material) and along which flows may become reintegrated to better conserve heat across the exposed reach.

Intentionally Left Blank

6.0 STRUCTURAL STORMWATER CONTROLS

6.1 Introduction to Structural Stormwater Controls

Structural stormwater controls are engineered facilities intended to provide water quality treatment for stormwater runoff and/or mitigate the effects of increased stormwater runoff peak rate, volume, and velocity due to urbanization. This section presents general guidance on selection and design of structural stormwater controls, considerations for cold weather conditions, and references to sources of related information.

6.2 Site Evaluation Considerations

The considerations listed below should be included in the designer's site evaluation and selection of appropriate structural stormwater controls. Additional considerations specific to each type of control, are discussed in subsequent sections.

Class V Injection Wells:

In order to provide clarification on which stormwater infiltration facilities have the potential to be regulated as Class V injection wells by the Underground Injection Control Program, the EPA released a memorandum addressing the subject in June 2008. (This memorandum is provided in Appendix F.) The memorandum generally states that LID is supported by the EPA and that most LID facilities are not considered Class V injection wells. Whole commercially manufactured subsurface infiltration devices are considered Class V injection wells. Dry Wells, Infiltration Trenches, and other LID elements vary depending on their dimensions. If a facility is considered a Class V injection well, the EPA must be notified and the facility will be added to their database of injection wells. To submit a Class V injection well application to the EPA, the applicant should complete the required EPA form (see link below) and provide relevant project information. Typically, project information includes a description of the facility, clarification of the types of fluids the injection well will accept (for stormwater facilities, this should be stormwater only), and a copy of the project design information. Upon receipt of the application, EPA will verify that the project is not located on a known contaminated site and that the infiltration facility maintains required separations distances from drinking water wells.

EPA Inventory of Injection Wells Form:

<http://www.epa.gov/region9/water/groundwater/uic-pdfs/7520-16.pdf>

Soil Infiltration Capacity:

Soil infiltration capacity is a critical parameter for the function of some of the stormwater controls described in this manual. In order to provide maximum design flexibility, a minimum infiltration rate for infiltration facilities is not specified in this manual. Practical infiltration rates will depend highly on the facility's contributing area and the design event the facility is sized for. Even with very low soil infiltration rates, many facilities can be sized to include additional storage volumes and longer residence times. However, this is often costly and may not be practical. As a general guideline for planning purposes, facilities that rely solely on infiltration tend to become less economical feasibly if infiltration rates are less

than 1 inch per hour. In these cases, it is often beneficial to consider facilities that include modifications for poorly infiltrating soils (such as bioretention) or facilities that provide a low ratio of contributing area to infiltration area (such as pervious pavement).

In cases where soil infiltration rates are very high (typically greater than 8 inches per hour), the potential for groundwater contamination should be considered in the facility design. If runoff is anticipated to contain high concentrations of pollutants or if the local groundwater is sensitive, the designer can consider measures to lower the infiltration rates, such as installation of an engineered fabrics or construction of a slower draining filter media, or pre-treatment could be provided.

In all cases of infiltration design, the elevation of the proposed facility should also be considered. Changing the facility elevation may result in changes in infiltration rates due to various subsurface soil layers.

Infiltration testing is required prior to the construction of stormwater controls that rely on infiltration. (Commercial projects are required to complete infiltration testing prior to permit approval.) Appendix G presents criteria for required infiltration testing. It is the responsibility of the designer to select stormwater facilities that are appropriate for the site conditions and to demonstrate that proposed facilities are suitably designed for the surrounding soil conditions.

It is important that stormwater facilities be designed based on a design infiltration rate. A design infiltration rate is usually selected by decreasing a field-measured infiltration rate by an appropriate factor of safety. This factor of safety is dependent upon the facility being considered, the site conditions, and the properties of the receiving soil. For example, if the facility is receiving high concentrations of sediments such that decreased infiltration over time is anticipated, the design infiltration rate should reflect the anticipated future conditions. Generally, a minimum infiltration rate of two is recommended and many cases warrant a higher factor of safety. When selecting a factor of safety, designers should consider the following site and design conditions:

- A. Facility Loading Rate. This is typically described as the ratio of the contributing area to the infiltration area. The higher the loading rate, especially when the contributing area is impervious, the more prone to failure a facility tends to be. In cases of high loading rates, conservative factors of safety are recommended.
- B. Sediment Load. If the runoff contributing to the infiltration facility is anticipated to contain high amounts of sediment, a more conservative factor of safety may be appropriate.
- C. Facility Maintenance. The designer should consider how frequently the infiltration facility will be maintained and the degree of maintenance required. If regular maintenance cannot be expected, a more conservative factor of safety may be appropriate.
- D. Repair/Replacement Options. Some facilities can be repaired more easily than others if they become clogged or slow-draining. For example, in a bioretention facility, replacing sediment-laden topsoil and re-vegetating the facility may restore a poorly performing facility to acceptable performance. However, in the case of an infiltration basin or trench, the native soil below the facility is collecting the sediment and repair of a poorly performing facility may involve excavating the facility floor and removing and replacing native soil. If maintenance or repair is generally more complex, a conservative factor of safety is recommended.
- E. Other factors of safety in the design process. Factors of safety may be included in other portions of the design process. For example, if the facility also has a storage capacity, the design storage

capacity can be sized with a factor of safety. Additionally, some designers may choose to apply factors of safety to rainfall analyses or selection of design storms. The designer should consider the whole analysis and determine an appropriate factory of safety for infiltration based on the entire design process. Over use of factors of safety may result in facilities that are unnecessarily costly and large.

- F. Facility design event. Infiltration facilities can be sized for a wide range of rainfall events. Some facilities are intended to provide only water quality treatment, while others are intended to capture and infiltration large storm events such as the 10-year and 100-year rainfalls. Facilities that are sized only for small, frequent events will have overflow or bypass mechanisms for larger events. The overflow/bypass also safe passage for water that is not able to infiltrate.
- G. Repercussions of facility failure. The designer is encouraged to consider the impacts of facility failure. In cases where downstream systems are designed to accept overflow water, the impacts of failure may be less severe than in cases where failure could result in property damage or other negative impacts.

Depth to Limiting Strata:

The properties of soils are frequently non-uniform with depth. A change in soil properties below the bottom of a structural stormwater control can affect the facility performance. For example, bedrock or Hydrologic Soil Group Class D soils below a stormwater facility can slow infiltration and require increased facility storage volume or, in some cases, inclusion of a subdrain in the facility design. Highly fractured bedrock may allow untreated discharge to reach groundwater. ***For structural stormwater controls that rely on infiltration, designers are required to obtain geotechnical information to a minimum of four feet below the proposed facility bottom and account for effects of any limiting strata in the design.***

Sediment Removal:

Stormwater sediments removed from publicly owned systems generally do not meet the criteria of “hazardous waste.” However, these sediments are contaminated with a wide array of organic and inorganic pollutants well beyond the levels of pollutants in the raw stormwater itself. Regardless of the source of these residual wastes from stormwater treatment, handling and disposal must be done with care. Potential locations for the disposal of sediment removed from the sedimentation basins should be evaluated during design, and sediment removal requirements must be included in the project’s O&M Manual. See Section 3.3 for additional information.

- A. Sediments from constructed wetlands or ponds must be carefully removed to minimize turbidity, further sedimentation, or other adverse water-quality impacts.
- B. Sediments from stormwater hotspots may require special disposal.
- C. Sediment disposal considerations shall be in accordance with ADEC requirements.
- D. Hydraulically transported sediments should go only to a secure disposal facility designed to hold the entire volume of sediment and the transport of water.
- E. Should a spill occur during transportation, prompt and thorough cleanup is important.

Proximity to Wells, Surface Waters, and Utility Lines:

Due to water quality concerns, it is necessary to consider the proximity of stormwater facilities to drinking water wells, surface waters, and potable water lines. (These considerations do not apply to lined facilities such as rain gardens.) According to 18 AAC 80.020 Table A, infiltration facilities must be separated by a

horizontal distance of 200 feet from the source of Community Water Systems, Non-Transit Non-Community Water Systems, and Non-Community Water Systems (formerly Class A or B wells) and 150 feet from the source of Class C public water systems.

The separation distances in Table 6.4-1 are recommended from the edge of various structural stormwater controls to the outside wall of drinking water lines. Separation distances may need to be increased for facilities being designed to accept hot spot runoff.

Depth to Groundwater:

To protect groundwater resources, it is important to provide ample separation between infiltration facilities and the surface of the local groundwater table. The required minimum separation distances from the seasonal high groundwater table elevation to the bottom of stormwater controls are shown in Table 6.4-1. Further discussions regarding depth to groundwater is provided in applicable stormwater control sections throughout this section.

Groundwater levels fluctuate from season to season and from year to year. The magnitude of the fluctuation depends on many factors including precipitation and snow-melt rates in current and preceding seasons. Groundwater in the Anchorage area typically has two annual “peaks”, generally occurring around mid-May and mid-October. In some locations, groundwater may peak at other times. When possible, groundwater levels for design of stormwater controls should be obtained during a seasonally high peak. In instances where this is not feasible, the designer should demonstrate that the design considers the potential for a higher groundwater table, or provide evidence that the levels used for design are considered seasonally high for the area. The acceptability of groundwater readings not obtained during a peak time will depend on the design and function of the facility; the facility sensitivity to groundwater; the potential for drinking water contamination; how close the facility design is to the minimum groundwater separation distance; and the facility’s overflow and/or bypass design.

Proximity to Contaminated Soil or Contaminated Groundwater

Unlined structural stormwater controls that rely on infiltration should not be used in locations with known contaminated soils or contaminated groundwater. Infiltration may cause transport of contaminants from the soil to the underlying groundwater table or may cause movement of contaminated groundwater. In particular, projects in groundwater recharge areas should avoid stormwater practices that promote infiltration and use techniques that treat and discharge stormwater instead. Porous pavement is especially problematic due to heavy pollutant loading in sensitive recharge areas; bioretention facilities are less problematic unless karst topography is present. In some cases, buildings and other impervious surfaces can be strategically located to act as caps over contaminated areas.

Additionally, new and redevelopment near contaminated sites should use green infrastructure practices to prevent additional runoff from flowing onto potentially contaminated areas. Local, state, and federal regulations apply to development on or near contaminated sites, and the contents of this manual do not supersede any applicable regulations.

Separation Distance from Road Subgrades and Foundations:

Designers should be aware of the potential impacts to road subgrades and building foundations when infiltrating into frost-susceptible soils. The designer is responsible for incorporating appropriate separation distances into facility designs. Appropriate separation distance is influenced by many factors including the following:

A. Proximity of the infiltration facility to foundations and subgrades

- B. The size of the infiltration facility and the quantity of water being directed to it
- C. The type of soil below and surrounding the infiltration facility
- D. The surface gradient from the infiltration facility to a foundation or subgrade
- E. The vertical elevation difference between the infiltration facility and the foundation or subgrade
- F. The size of the subgrade or foundation zone of influence
- G. Other site-specific considerations

The relationship between infiltration facilities and adjacent soils and foundations can be complex. The designer is responsible for appropriate placement of facilities based on the considerations listed above, and input from the project geotechnical engineer is recommended. At a minimum, the following design restrictions apply.

- A. Infiltration facilities located within 25 feet of a road subgrade or building foundation require installation of a facility underdrain, unless 1) the project engineer demonstrates that the infiltration area is outside of the zone of influence of the foundation or 2) the native soils are considered non-frost susceptible.
- B. Infiltration facilities not located within 25 feet of a road subgrade or a building foundation require a sub-drain if the soils are classified as F-4. A subdrain should also be considered if the soils are F-3, and incorporated when the designer thinks it is warranted based on the considerations listed above.

Note that separation from the subgrade of pervious pavements is not required when the subgrade is designed for appropriate interaction with infiltrated water.

Hotspot Runoff:

Hotspot runoff shall not be directed to structural stormwater controls that rely on infiltration or provide opportunity for infiltration into the native soil unless chemical or other approved pretreatment is provided. Appropriate pretreatment requires MOA approval and must be based on the specific pollutants expected to be found in the contaminated runoff. The ability of each facility to accept hotspot runoff is presented in each structural stormwater control section. More information on the definition of hotspot runoff is provided in Section 3. References to hotspot runoff pretreatment throughout this section must comply with this section.

6.3 Cold Weather Considerations

Water quality treatment devices in Anchorage are intended to provide treatment during summertime rainfall events when most pollutant washoff to receiving waters occurs. The design criteria presented in this section does not consider water quality treatment during winter or spring snow melt conditions. That said, many structural stormwater controls will continue to provide treatment benefit during these conditions. Several organizations have completed research and published findings on this topic. If the designer is interested in maximizing possible treatment during these times, possible resources are provided below:

- A. *Seasonal Performance Variations for Stormwater Management Systems in Cold Climate Conditions*. Published in the Journal of Environmental Engineering, March 2009. Website:

http://www.unh.edu/unhsc/sites/unh.edu.unhsc/files/pubs_specs_info/jee_3_09_unhsc_cold_climate.pdf

- B. Stormwater BMP Design Supplement for Cold Climates. Center for Watershed Protection, December 2007. Website: http://vermont4evolution.files.wordpress.com/2011/12/ulm-elc_coldclimates.pdf

Even if facilities are not designed for treatment during winter months, some water quality treatment tools are also used for runoff management for larger events, and consideration of performance during winter time rain and snow melt events may be needed. These types of considerations are presented below.

Pipe Freezing:

Many stormwater controls rely on some type of piping system at the inlet and outlet. Frozen pipes can crack due to ice expansion, creating a maintenance or replacement burden. In addition, frozen pipes reduce the treatment capability of the stormwater control by restricting or completely blocking the inflow or outflow to the facility and can increase the potential for flooding.

Consideration should be given to the sizing and location of inlets and outlets to avoid ice clogging and freezing. Further, a well-drained system should be designed and maintained so that water drains out rather than storing and freezing.

Increased Volumes During Spring Snow Melt:

Stormwater facilities in Anchorage are not designed to provide water quality treatment for spring snow melt conditions. However, runoff volume from spring snowmelt events and rainfall plus snowmelt can be very large, often the largest-volume event of the year. The designer should consider the capacity of cold-weather stormwater facilities, and provide appropriate volume or bypass/overflow in the design.

Ice Formation on the Permanent Pool:

In facilities that have a permanent pool of water, ice formation can reduce the volume capacity of the pond. Some authorities recommend that the permanent pool volume be increased by an amount equal to the expected volume of the ice cover or that extended storage be incorporated into the pond's design. Another option is to increase the depth of the pond at the inlet and outlet, creating more room for ice to collapse. These features will usually result in designs that are robust enough to handle winter and spring runoff conditions.

Pond structures should be carefully selected to withstand ice conditions: Once ice begins to melt and break apart, ice movement can cause damage to structures in the pond. For example, standpipe outlets are particularly susceptible to ice damage.

Frost Heave:

Frost heaving is a rising of the soil surface during cold periods. One of the sources of frost heaving is the expansion of pore water as it freezes under the ground's surface. An additional, and perhaps more important source is the formation of ice lenses, or layers of ice, below the soil surface. The primary risk associated with frost heave is the damage of structures such as pipes, concrete materials used to construct stormwater facilities, and pavement.

The designer should consider recommended minimum depths of cover and backfilling practices to reduce the potential for pipe freezing and frost heave. Additionally, facilities should be designed, constructed, and maintained to be well-drained to minimize potential for frost heave.

Reduced Infiltration:

The rate of infiltration in frozen soils can be limited, especially when ice lenses form. As a result, facilities that rely on infiltration to function may be ineffective when soil is frozen, which in cold climates can be a significant portion of the year. It is important to note, however, that some frozen soils can continue to infiltrate water year-round, depending on soil porosity and water content. Additionally, depending on the application of the infiltration facility, performance under frozen conditions may not be needed.

If infiltration facilities are designed for events other than water quality treatment (such as collection and disposal of 10-year or 100-year events), the infiltration zone should be placed below the frost line or protected from freezing by insulation.

Snow Management and Disposal:

It is preferable not to use structural stormwater controls for snow storage during winter months. However, some sites may not have sufficient space available for alternate storage areas. If structural stormwater controls are used for snow storage, the facilities should be oversized to accommodate both the increase in water volume during snowmelt and the increased sediment loads (see previous section). Adverse impacts to surrounding or downstream properties is prohibited.

Sediment Loading During Snowmelt

Increased volumes of sediment may be directed to the facility during spring snowmelt. Facility design and pretreatment design should consider this sediment loading to ensure that clogging does not occur, particularly for facilities that rely on infiltration.

Special Maintenance:

Stormwater facilities designed to function effectively in summer are often disrupted by winter and spring events. Inspection and maintenance during spring runoff should be a consistent feature of stormwater treatment systems in cold climates. Additionally, vacuum sweeping of permeable pavement should be performed immediately following snowmelt in the spring.

6.4 Selecting Appropriate Stormwater Controls

Selection of stormwater controls that are appropriate for the intended use is critical to the success of the facility. In considering which stormwater controls may be appropriate for a particular site, the designer should ask the following questions:

- A. What is my goal for the stormwater control? What benefit does it need to provide? Water quality treatment through Green Infrastructure? Peak flow reduction? Treatment of hotspot runoff? Once you have identified the intended use of the stormwater control, you can select a system to meet this need.
- B. What are my site constraints? This should include considerations such as depth to groundwater, depth to bedrock, surrounding facilities or infrastructure, infiltration rates, site size and layout etc. Specific site constraints may limit the stormwater controls that are feasible for your site.
- C. What type of runoff will my site discharge? If the proposed site will discharge contaminated or “hotspot” runoff, some stormwater controls may not be appropriate, or pre-treatment may be required.
- D. How will I ensure that I am not adversely impacting surrounding or downstream properties?

Adverse impacts to surrounding or downstream properties are prohibited. The designer must design each site and select stormwater controls such that adverse impacts are avoided for both extreme rainfall events and snowmelt events.

- E.** What is the availability for long-term maintenance? Some facilities require more maintenance than others. Neglecting maintenance needs can result in facility failure over a period time.

On the following page, Table 6.4-1 provides general guidance and considerations to assist the designer with selecting appropriate stormwater controls.

Table 6.4-1: Stormwater Controls Selection Guide

Structural Stormwater Controls	RUNOFF		SUITABLE TO MEET SW MANAGEMENT REQUIREMENT		IMPLEMENTATION CONSIDERATIONS		
	Rate Control	Volume Reduction	Green Infrastructure Treatment	Detention and Peak Flow Control	Accepts Hotspot Runoff	Separation from Groundwater ⁵ (feet)	Separation from Drinking Water Mains (feet)
Bioretention Facilities	Moderate	Moderate	✓	✓	Yes ³	2 ⁶	0
Soakaway Pits	Moderate	High	✓	✓	No ⁷	2	10
Infiltration Basins	Moderate	High	✓	✓	No ⁷	2	10
Infiltration Trenches	Moderate	High	✓	✓	No ⁷	2	10
Vegetative Swales	Moderate	Moderate	✓	✓	No ⁷	2	0
Pervious Pavement	Moderate	High	✓	✓	No	2	10
Chamber Systems	High	High	✓	✓	No ⁷	2	10
Wet Ponds	High	Low	✓	✓	No ⁷	N/A	10
Dry Ponds	High	Low ¹	*3	✓	No ⁷	N/A	10
Oversized Pipes	High	Low		✓	Yes ⁴	N/A	10
Filter Strips	Low - Moderate ²	Low – Moderate ²	✓	✓	No ⁷	2	0
Constructed Wetlands	Moderate - High	Moderate	✓	✓	Varies ³	N/A	10
Natural Vegetation Retention/ Tree Canopy	Low-Moderate	Low-Moderate	✓		No ⁷	N/A	N/A
Landscaped Depressions	Moderate	Moderate	✓	✓	No ⁷	2	N/A
Sedimentation Basins	High	Low	✓	✓	No ⁷	2	10
Oil and Grit Separators	Low	Low			Yes	N/A	10

(1) May provide some volume reduction depending on permeability of native soil.
 (2) Increased performance when level spreaders are incorporated into the design.
 (3) Yes, under specific conditions. See design criteria section for further detail.
 (4) Hotspot runoff still requires treatment.

(5) Minimum separation distance between the seasonal high groundwater table elevation and the bottom of structural stormwater controls.
 (6) Modifications are available for locations with high groundwater. See specific design criteria section for further detail.
 (7) May be allowable with appropriate pre-treatment.

6.5 Stormwater Pond Safety Consideration

Safety is a critical consideration when designing a stormwater pond. Unsafe condition can occur under both dry and wet conditions. This section outlines general considerations and requirements related to safety with stormwater ponds. Specific design criteria for various types of stormwater ponds and basins is provided in subsequent sections. However, this safety criteria applies to infiltration basins, wet ponds, dry ponds, sedimentation basins, and other types of stormwater ponds not addressed in this manual.

This safety discussion is not all-inclusive. Safe design is site specific and a comprehensive look at the location, function, surroundings, and potential hazards should be an integral part of any stormwater pond design. Much of the information in this section was taken from the paper *Essential Safety Considerations for Urban Stormwater Retention and Detention Ponds*. Designers are encouraged to review the full paper, which can be found at the link below.

<http://www.udfcd.org/resources/pdf/conferences/conf2006/5-1%20Jones%20Safety%20Considerations.pdf>

Inlet and Outlets

- A. Outlets pose particular risks and merit special attention. Open, unprotected pipes are not permitted as outlets. Instead, integrate the outlet pipe into an outlet structure that has smaller openings, and/or utilize a sloping trash/safety rack at the pipe entrance. The rack should have a surface area that is many times larger than the surface area of the outlet pipe to reduce entrance velocities (which is necessary to minimize the risk of a person being pinned against the rack) and to assure that if debris is a factor, at least some of the surface area of the rack will be open during flooding to enable the pond to drain.
- B. When feasible, place the outlet away from areas of heavy public use such as playgrounds, parks, schoolyards, etc. Screen the outlet so that the public will not be “drawn” to it. Thick shrubs, grading techniques and aesthetic fencing/railing can be useful in this regard. Assure that embankment side slopes adjacent to the outlet structure are not too steep to enable people to scramble away from the structure as pond waters are rising. (See discussion of side slopes below.)
- C. Separate inflow and outflow pipes by long distances and assure that the pipes are not directly across from each other. This will avoid the creation of a continuous flow stream (current), which poses special dangers for the public. If this is not feasible, utilize an energy dissipater at the outlet where it discharges into the detention facility.

Observation and Education

- A. Owners are advised to periodically observe the facility to ascertain how the public interacts with it. Owners should also consider the comments received from adjoining property owners. For example, if children are skateboarding on concrete pans in the bottom of a dry basin, they should be told to not do this and warned of the hazard. Signs that say “No Skateboarding” may be helpful, although it may also be necessary to create a rough surface to make skating difficult. For facilities that are on private property, it is often feasible to have them included on security watches. Security staff should be instructed to pay particular attention to them during runoff

events.

- B. Community education can be a valuable tool. Use signs that warn of rapidly rising floodwater and educational, interpretative signs that explain how the stormwater storage facilities work. Urge local radio and television stations to include short public service announcements that emphasize the hazards posed by storm drainage facilities. Educate school children to these risks. Distribute flyers. Inform homeowner associations and property owner associations (for commercial areas) of these risks.
- C. Ponds are often located near public facilities such as recreation centers, libraries, fire stations, etc. Staff can be asked to observe the storage facility during dry and wet weather conditions and to identify potential hazards. Similarly, facilities in office parks and industrial complexes are often visible to workers, and they can be asked to identify potential hazards.

Adjacent Land Use

Designer shall attempt to separate certain land uses, such as preschools, from ponds or incorporate obstacles that will assuredly prevent access.

Side slopes and Benching

- A. Side slopes and benching are key factors in maintaining a safe stormwater pond. If a person, especially a child, approaches the pond, mild slopes help prevent the child from falling in. Additionally, if someone does enter or fall into the pond, mild slopes allow them to climb or be helped out of the pond safely.
- B. In all cases, side slopes for stormwater ponds within the MOA shall be no steeper than 3H:1V. When the depth of the pond is greater than four feet and the slope is steeper than 4H:1V, a safety bench is required. The safety bench shall have a slope of 10H:1V, and shall be located such that the design water surface elevation or permanent pool elevation is between the top and bottom edge of the bench.

Fencing

- A. The question of whether or not to construct fences around detention facilities is complicated, with arguments both for and against the practice. Ultimately, the decision should be site specific and there should be a good rationale for whatever decision is made.
- B. Fences certainly discourage some people from accessing ponds. Fences lend themselves to the installation of warning signs. Provided that fencing materials are carefully selected and well maintained, fences can be aesthetic.
- C. On the other hand, many children or youths will view crossing a fence as a worthy and exciting challenge. Fences can also be unattractive, poorly maintained eyesores. Often, ponds surrounded by fences are not as well maintained as those that are in the open, and more visible. Ironically, if a situation does occur involving public safety, reaching the person who requires assistance will be impeded by a fence. If the safety issues are addressed using many of the other techniques described in this paper, it should not be necessary to fence the facility.
- D. Isolated lengths of fence can be desirable, provided that they are attractive and properly integrated into the overall site plan (again, this emphasizes the value in engineers working

closely with landscape architects during design). For example, it can be valuable to include a fence at the top of a steep slope to discourage access.

- E. Alternatives to fencing to discourage access and promote safety include education, site grading, signing, planting of thorny shrubs, and grading for “safety ledges” along the pond perimeter.

Site Considerations

Reduce the number of small, “onsite” ponds that are used in new residential and commercial developments by appropriate drainage master planning, minimizing directly connected impervious area, utilizing Low Impact Development (LID) measures, and emphasizing larger, regional storage facilities. It should not be necessary for every new convenience store, gas station, and fast food outlet to have its own dry detention pond, as this needlessly compounds public risks and creates other problems.

Maintenance and Monitoring

Regularly inspect/maintain the detention facility. Anticipate potential problems. Look at the impoundment from the perspective of someone who knows nothing about the risks that such facilities pose. Look for potential hazards and address them.

Dam Considerations

Recognize that detention facility dams can be hazardous and use care in their design. Assure that all aspects of dam safety, ranging from upstream and downstream sideslopes to spillway adequacy to behavior of pond during overtopping, are addressed. In particular, acknowledge that floods larger than the 100-year event can and will occur, and determine how the dam will behave under such conditions. If the dam is anticipated to fail during extreme floods, analyze the downstream impact of such failure.

Mosquito Control

- A. Take steps to eliminate shallow, shallow-stagnant water in the bottom of “dry” basins that can be conducive to mosquito breeding. For example, determine maximum groundwater table elevations prior to design. Do not utilize outlet structure designs that are subject to plugging. Consider the use of gravity underdrains.
- B. Because mosquitoes generally require a stable, shallow, and stagnant water surface for at least three days to reproduce, design ponds to drain the water quality design storm in less than 72 hours and utilize fountains/aerators in wet ponds to induce waves. Over the past few years, there have been many articles in the stormwater literature about mosquito control, and readers are urged to become familiar with this subject and to address it during design and operations/maintenance.

Hydraulic Structures

Hydraulic structures shall be designed and constructed in a manner that minimizes hazards. For example, steel bars on grates shall be beveled, rounded, or covered with no sharp ends. Bolts shall not have jagged, exposed ends. Wide gaps between steel bars and concrete walls shall be avoided to prevent access, especially by children.

6.6 Design Criteria for Structural Stormwater Controls

This section provides design criteria and guidance for a variety of structural stormwater controls (or LID elements). The controls presented in this section have been selected by the MOA for their versatility and applicability to the Anchorage climate. There are a variety of stormwater controls and Green Infrastructure/LID elements that are not discussed here that may be applicable to specific situations. The designer is encouraged to explore additional stormwater controls and LID elements. In some cases, the controls presented in this section can also be combined and used concurrently or in series.

It should be noted that many of the sizing equations provided in this manual are based on sizing facilities for a total runoff volume that arrives at the facility all at one time. If structural stormwater controls are intended to provide additional detention or retention such that facilities will be designed to store the runoff volume accumulating over a period of time, then inflow and outflow hydrographs as well as appropriate routing techniques are required for adequate sizing.

Recommended references for additional information are provided below.

Recommended References:

Barr Engineering Company, Minnesota Urban Small Sites BMP Manual, 2001
(<http://www.pca.state.mn.us/index.php/water/water-types-and-programs/stormwater/stormwater-management/stormwater-best-management-practices-manual.html?menuid=&redirect=1>)

Georgia Stormwater Management Manual, Volumes 1 and 2, 2001
(<http://www.georgiastormwater.com/>)

6.6.1 Bioretention Facilities

<p>Description</p> <p>A shallow stormwater basin or landscaped area that utilizes engineered soils and vegetation to capture and treat runoff. Examples include rain gardens and bioretention swales.</p>																									
<p>Stormwater Management Suitability</p> <table border="0"> <tr> <td colspan="2">Runoff:</td> <td rowspan="2">Suitable to meet or help meet requirements for:</td> </tr> <tr> <td>Rate Control:</td> <td>Moderate</td> </tr> <tr> <td>Volume Reduction:</td> <td>Moderate</td> <td>Water Quality Treatment through Green Infrastructure ✓</td> </tr> <tr> <td colspan="2">Implementation Considerations:</td> <td>Detention ✓</td> </tr> <tr> <td>Land Requirement:</td> <td>High</td> <td>Pre-treatment ✓</td> </tr> <tr> <td>Capital Cost:</td> <td>Moderate</td> <td></td> </tr> <tr> <td>Accepts Hotspot Runoff:</td> <td>Yes¹</td> <td></td> </tr> <tr> <td>Maintenance:</td> <td>Moderate</td> <td></td> </tr> </table>			Runoff:		Suitable to meet or help meet requirements for:	Rate Control:	Moderate	Volume Reduction:	Moderate	Water Quality Treatment through Green Infrastructure ✓	Implementation Considerations:		Detention ✓	Land Requirement:	High	Pre-treatment ✓	Capital Cost:	Moderate		Accepts Hotspot Runoff:	Yes ¹		Maintenance:	Moderate	
Runoff:		Suitable to meet or help meet requirements for:																							
Rate Control:	Moderate																								
Volume Reduction:	Moderate	Water Quality Treatment through Green Infrastructure ✓																							
Implementation Considerations:		Detention ✓																							
Land Requirement:	High	Pre-treatment ✓																							
Capital Cost:	Moderate																								
Accepts Hotspot Runoff:	Yes ¹																								
Maintenance:	Moderate																								
<p>Key Considerations</p> <p>Advantages:</p> <ul style="list-style-type: none"> • Ideally suited to highly impervious areas • Reduces downstream flooding and protects streambank integrity • Provides groundwater recharge and base flow in nearby streams • Adaptable to poorly infiltrating soils and high groundwater • Can be used as a stormwater retrofit <p>Limitations:</p> <ul style="list-style-type: none"> • Not recommended for areas with steep slopes • Pretreatment for sediment removal may be required, especially for Bioretention serving roads and parking lots. • Tend to consume space <p>Design:</p> <ul style="list-style-type: none"> • Best suited for small contributing drainage areas • Best applied to areas with relatively shallow slopes • Treatment area consists of a grass filter (if space permits), ponding area, organic/mulch layer, engineered soil, and vegetation. Subdrains and/or an impermeable liner may be included if site conditions permit. 																									

(1) Impermeable liner required. Appropriate plants and other vegetation must be selected for expected pollutant load.

Description:

In general, Bioretention Systems can be described as shallow, landscaped depressions that receive stormwater runoff. Bioretention systems are commonly located in parking lot islands, along roadways, or

within small pockets in residential areas. Stormwater flows into the bioretention area, ponds on the surface, and gradually infiltrates into the amended growing media. Pollutants are removed by a number of processes including adsorption, filtration, phytoremediation, evapotranspiration, ion exchange, and decomposition. Filtered runoff can be allowed to infiltrate into the surrounding soil, or collected by an under-drain system and discharged to a conveyance system or directly to receiving waters. Runoff from larger storms is generally diverted past the area to the storm drain system or other conveyance infrastructure.

Bioretention areas are extremely versatile systems and can be adapted to site constraints such as poorly infiltrating soils, high groundwater, and contaminated soils. They can also have varying geometric forms, making them adaptable to many types of site layouts.

Several variations of bioretention exist. In this section, the standard case is presented first, followed by a discussion of allowable adaptations for site constraints such as high groundwater, poorly infiltrating soils, and contaminated soils. A summary of design modifications based on site constraints is presented in Table 6.6-1. Conceptual profile drawings of the various types of bioretention facilities are presented in Figure 6-6-1 a, b, and c.

Advantages:

- A. Reduces the size and cost of downstream stormwater control facilities and/or storm drain systems by infiltrating stormwater in upland areas.
- B. When properly designed and maintained, more likely to be aesthetically pleasing than other types of filtration or infiltration systems due to incorporation of plants.
- C. Reduces the volume of runoff from a drainage area.
- D. Can be very effective for removing fine sediment, trace metals, nutrients, bacteria, and organics.
- E. Layout of bioretention facilities can be very flexible, and the selection of plant species can provide for a wide variety of landscape designs.
- F. Can be applied in many different climates and geologic environments, with some minor design modifications.
- G. Adaptable to a variety of site constraints including high groundwater, poorly infiltrating soils, and contaminated sites.
- H. Ideally suited to highly impervious areas, such as parking lots.
- I. Reduces downstream flooding and protects streambank integrity.
- J. Provides groundwater recharge and baseflow in nearby streams.
- K. Reduces local flooding.
- L. Can be used as a stormwater retrofit, by modifying existing landscaped areas, or if a parking lot is being resurfaced.

Figure 6.6-1 a, b, and c: Conceptual Bioretention Profiles

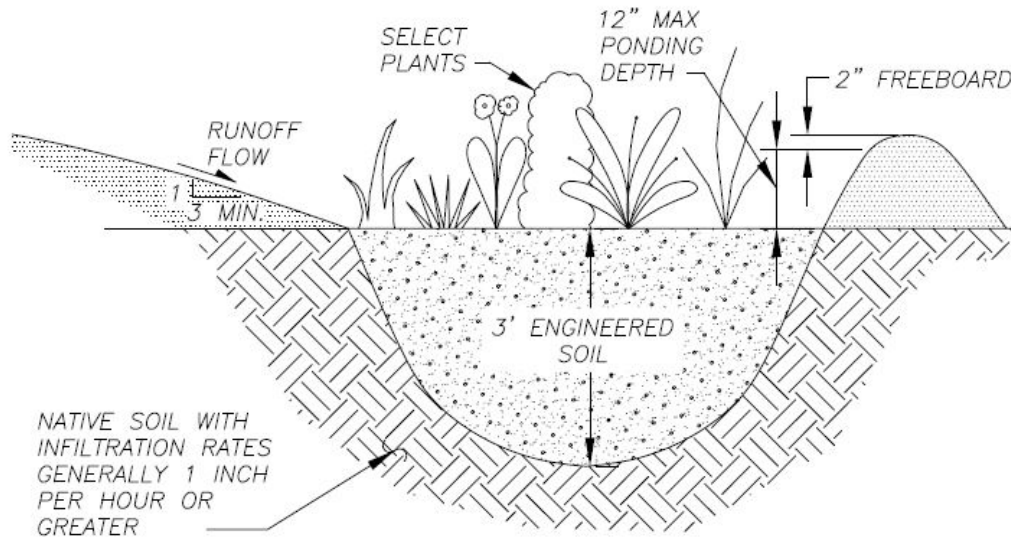

a - Standard Bioretention Profile

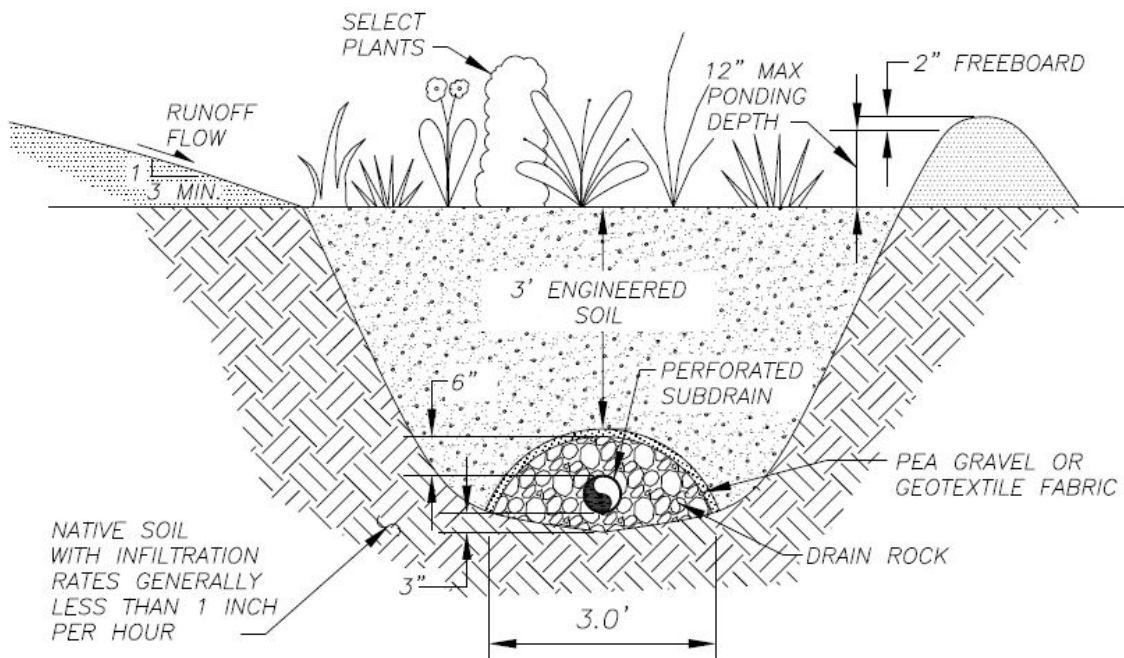

b - Bioretention Profile Modification 1

For poorly infiltrating soils or limiting strata within 4 feet of the facility floor.

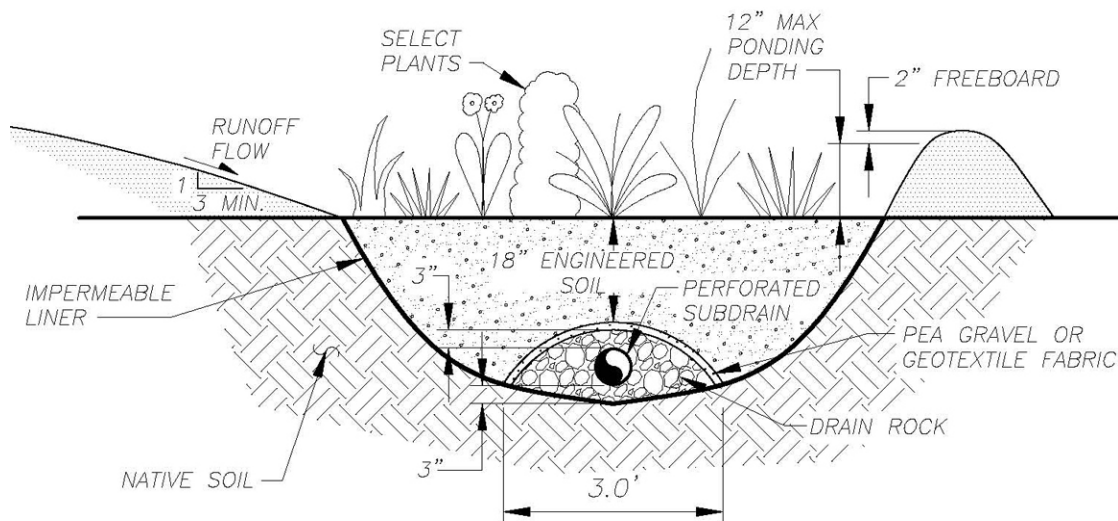

c - Bioretention Profile Modification 2

For groundwater less than 2 feet from the facility floor, contaminated sites, or when separation distances from wells, surface waters, utilities, road subgrades, or foundations cannot be met.

Limitations:

- A. Cannot be used to treat large drainage areas with a single facility. Multiple smaller facilities would be required.
- B. Can be susceptible to clogging by sediment, and pretreatment may be required depending on anticipated sediment loads especially when serving parking lots and roadways.
- C. Tend to consume space (usually around 10 percent of the area that drains to them).
- D. Incorporating bioretention into a parking lot design may reduce the number of parking spaces available.
- E. Construction cost can be relatively high compared with other stormwater treatment practices.

Design:

Site Sensitivity Analysis:

- A. Before construction, designers must consider the site conditions to ensure that a bioretention system is appropriate for the site.
- B. Drainage area: Bioretention areas should usually be used on small sites (i.e., five acres or less) or multiple bioretention areas should be incorporated into the design. When a single bioretention facility is used to treat larger areas, it tends to clog. In addition, it is difficult to convey sheet flow from a large area to a single bioretention area.
- C. Available area for the bioretention system: The surface area of the bioretention system should be approximately five percent of the contributing impervious area if it is serving paved areas such as roadways and parking lots. (See footprint sizing discussion for additional information.)
- D. Soils: Bioretention areas can be applied in almost any type of soil. For soils with appropriate

infiltration rates (generally 1 to 2 inches per hour or greater), runoff flows through the system's growing media and then naturally infiltrates into the native soil below. (See design modifications section for changes to this parameter for site constraints such as poorly infiltrating soil.)

- E. Slope: Bioretention areas are best applied to areas with relatively shallow slopes (usually about five percent). It's important to consider the slope of adjacent properties that are down gradient of the site to limit the possibility of seepage from the subgrade to the ground surface at lower elevations. For this reason, unlined bioretention areas should not be used when the average slope of an adjacent down gradient property is 12 percent or greater. This consideration does not apply to lined bioretention areas.
- F. See Section 6.2 for applicable setbacks. Separation distances from groundwater, bedrock, or other limiting strata vary with specific design modifications. See Table 6.4-1.

General Design Considerations:

Pretreatment-

Bioretention systems are susceptible to clogging from sediments. Therefore, pretreatment should be a fundamental component of any bioretention system in order to remove as much of the suspended solids from the runoff as possible before it reaches the bioretention system. Pretreatment will help to ensure the proper functioning of the bioretention area and allow for longer periods between maintenance. Common pretreatment methods for bioretention areas are vegetated filter strips or swales upstream of the bioretention area.

Engineered Soil (also known as Growing Media)-

The engineered soil or growing media consists of an engineered topsoil and provides water and nutrients to support plant life in the bioretention system. Stormwater filters through the soil where pollutants are removed by the mechanisms of filtration, phytoremediation by plants, adsorption and biological degradation. In order for the soil to provide adequate treatment, the minimum depth of engineered soils is 3.0 feet. (See design modifications section for changes to this parameter for site constraints such as high groundwater.) Additional information regarding Engineered Soil is presented in Appendix H. It should be noted that engineered soil for use in applications like bioretention facilities is not considered structural fill and should not be compacted in accordance with structural fill compaction requirements.

Organic Mulch Layer-

It is recommended that a two to three inch mulch layer placed on the top of the bioretention system. The organic mulch layer has several functions. It protects the soil bed from erosion, retains moisture in the plant root zone, provides a medium for biological growth and decomposition of organic matter, and provides some filtration of pollutants. It serves as a primary treatment mechanism for removal of sediment and metals and extends the life-cycle of the Bioretention system due to reduced clogging potential.

Footprint-

The bioretention area footprint is the total area of the bioretention area in plan view. The bioretention area footprint is a function of the target treatment volume, ponding depth, and side slopes. The equation below provides the minimum foot print for the bioretention area based on physical parameters. However, it should be noted that the size of the footprint is directly related

to the facility's long-term performance and the anticipated sediment loading. For improved long term performance, it is recommended that the bioretention area footprint be at least 5 percent of the size of the contributing impervious area. This is especially important if the facility will be collecting runoff from roadways or parking lots or if the contributing area will be sanded in the winter.

The bioretention area should be designed to pond a maximum of 12 inches above the filter bed. In addition to this ponding depth, a freeboard of two inches is also required. The recommended side slope for a bioretention area is a maximum of 3:1.

The equation for determining the minimum bioretention area footprint is provided below.

$$A_r = \left(\frac{TIV * d_{es}}{I * (P_d + d_{es}) * t} \right)$$

When:

A_r = Bioretention area Footprint (square feet)

TIV = Target Infiltration Volume (cubic feet)

P_d = Depth of Poned Water (ft)

d_{es} = Depth of Engineered Soil (ft)

I = Infiltration rate of the native soil at the bottom of the bioretention area (ft/hr)*

t = Facility drain-down time (48 hours maximum)

**Note: For lined bioretention areas with subdrains, substitute variable I with I_e , the infiltration rate of the engineered soils.*

Bioretention areas are an extremely versatile in terms of plan view geometry. They can take nearly any shape to fit within the site plan. While there is a great deal of freedom associated with specifying the shape of a bioretention area, it is important to consider that runoff discharging to the bioretention area should be spread evenly across the surface of the area to promote infiltration across the entire facility.

Depth-

The total depth of a bioretention area is the depth from the freeboard elevation to the bottom of the excavation. For bioretention areas that do not include a subdrain or underground overflow structure within the boundary of the facility, the total depth can be calculated with the following relationship.

$$D_r = \frac{P_d + M_d + F_d}{12} + E_d$$

When:

D_r = Total Depth of Bioretention area without Subdrain (feet)

M_d = Depth of Mulch (inches)

P_d = Depth of Poned Water (inches)

F_d = Freeboard (inches)

E_d = Depth of the Engineered Soils (feet)

For bioretention areas that do include a subdrain or underground overflow structure within the

boundary of the bioretention area, the total depth can be calculated with the following relationship.

$$D_{rs} = \frac{P_d + M_d + F_d}{12} + E_d + S_d + 0.005 * L_r$$

When:

D_{rs} = Total Depth of Bioretention area with Subdrain (feet)

P_d = Depth of Pondered Water (inches)

M_d = Depth of Mulch (inches)

F_d = Freeboard (inches)

E_d = Depth of the Engineered Soils (feet)

S_d = Depth Required for Subdrain Diameter and Drain Rock (feet)

L_r = Approximate Length of Bioretention area, Along the Axis of the Subdrain (feet)

Note: The equations above are intended to assist designers in the conservative estimation of the depth required for the bioretention area at its deepest point. The exact depth is determined during final design.

Overflow structure-

In most cases, an overflow structure or separate conveyance system should be provided to convey flow from large storms (storms that are not treated by the bioretention area) to a downstream facility or stormdrain system. Overflow structures can be weirs, pipes, inlets, etc. See Figure 6.6-2 for an example of an inlet overflow structure. In figure 6.6-2, the overflow manhole structure could also be perforated to allow for additional infiltration or inflow of groundwater if conditions become over-saturated.

If earthen berms or weirs are used as overflow structures, the design shall include provisions to protect the earthen from erosion. Many types of erosion control products are available for this type of application.

Vegetation-

Bioretention area plants will assist in the stormwater treatment process and contribute to the aesthetic value of the facility. It is preferable to use native plants, since they will require less maintenance. If non-native plants are used, they should not be invasive species. There are a wide variety of plants available for use in a bioretention area. For large plant orders, coordinate with nurseries early to assure an adequate supply will be available. Generally speaking, the selected plants should be tolerant to a wide variety of moisture and salinity conditions, and should not interfere with utilities in the area. In the selection of bioretention area plants, it is also important to consider the potential for attracting wildlife. Additional guidance with selecting non-invasive plant species appropriate for bioretention systems is presented in Appendix E. Plants should be selected to tolerate both wet and dry conditions; plants that require ongoing inundation should not be used.

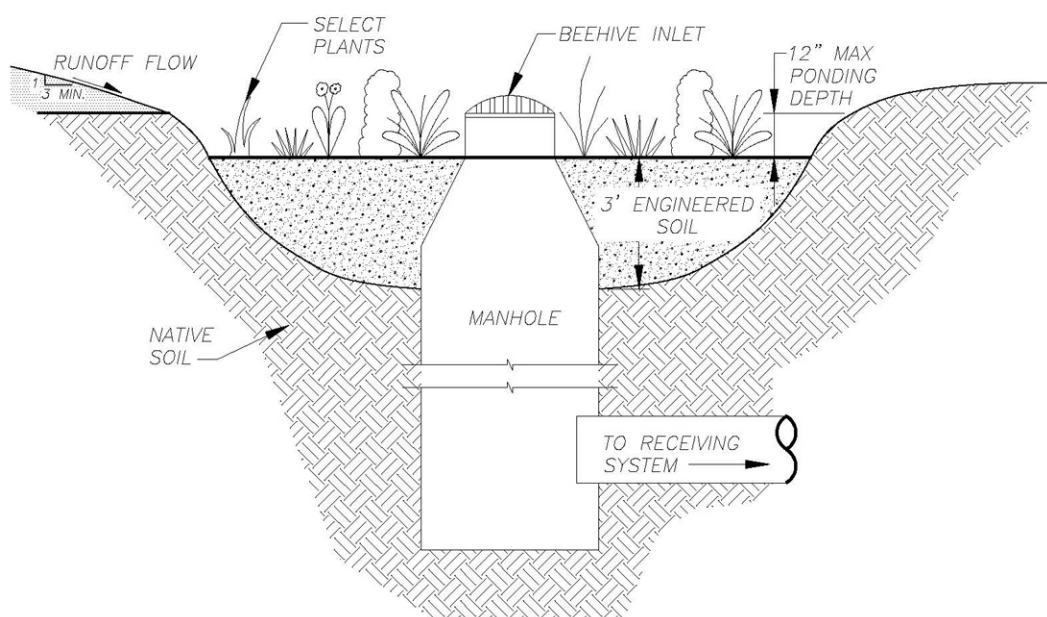
Figure 6.6-2 - Example Overflow Structure for Bioretention Area

Design Modifications for Various Site Constraints

Design Modification 1 - Subdrain. This design modification is recommended for cases of (1) poorly infiltrating soils (approximately 1 inch per hour or less) or (2) strata that would limit infiltration, such as bedrock or the groundwater table, within 4 feet of the facility floor. See Section 6.2 for more information regarding infiltration rates.

The bioretention facility Modification 1 includes a subdrain. A subdrain is a perforated pipe surrounded by gravel that collects and removes filtered runoff, directing it to a receiving system or outfall. In this case, runoff percolates through the engineered growing media, and what is not stored in the growing media is returned to the receiving system by the subdrain. See Figure 6.6-1(a).

Minimum subdrain diameter for bioretention systems is 4-inches. The subdrain pipe is placed on a layer of drain rock that is a minimum of three feet wide and three inches thick. A six-inch thick layer of drain rock should be placed above the drainpipe. Drain rock should be washed, non-fractured, $\frac{3}{4}$ " minus material.

An aggregate filter blanket diaphragm (pea gravel) or engineered geotextile fabric should be placed in a four-inch layer above the drain rock to reduce the potential for clogging.

Note that in some cases, subdrains may be elevated below the facility bottom to provide additional storage and opportunity for infiltration if the facility is not lined. Designers should carefully consider the storage volume needed; it will vary depending on the facility's intended function.

Design Modification 2 - Impermeable Liner and Subdrain. This design modification is required for the following cases:

1. The bioretention facility floor is less than 2 feet from the seasonally high groundwater table.
2. Minimum separation distances from building foundations, road subgrades, or surface or groundwater sources cannot be achieved. (See Section 6.2 and Table 6.4-1 for required separation distances.)
3. Infiltration from the facility has the potential to cause movement of contaminated groundwater or if surrounding soils are known to be contaminated and infiltration may cause movement of contaminants.

Design Modification 2 includes a subdrain, as described in Modification 1, but the facility also includes an impermeable liner. The impermeable liner prevents any runoff that enters the facility from percolating into the native soil while still providing some detention, retention, and treatment benefit. Lined bioretention areas should be lined with 30-mil polyethylene plastic with welded joints. Lined bioretention areas always require a subdrain.

If the facility is constructed with under this modification, the growing media depth can be reduced to 18 inches and the drain rock later on top of the subdrain may be reduced to 3 inches. A summary of design modifications based on site constraints is presented in Table 6.6-1.

Table 6.6-1: Design Modifications for Bioretention Systems

Site Constraint	Subdrain Recommended	Liner and Subdrain Required	Reduced Growing Media Depth Allowed	Reduced Drain Rock Thickness Allowed
Modification 1 - Poorly infiltrating soils (generally about 0.5 to 1 inch/hour) or other limiting strata such as bedrock or groundwater within 4 feet of the facility floor	✓			
Modification 2 - Local groundwater table less than 2 feet from facility floor.		✓	✓	✓
Modification 2 - Infiltration of stormwater will cause movement of contaminated groundwater or cause soil contaminants to move into the groundwater.		✓	✓	✓

Maintenance:

Bioretention requires seasonal landscaping maintenance. In many cases, bioretention areas require intense maintenance initially until plants are established, but less maintenance in the long term. Designers should ensure that the bioretention area is easily accessible for maintenance. Table 6.6-2 on lists the typical maintenance activities for bioretention areas.

Table 6.6-2: Summary of Maintenance Activities for Bioretention Areas

Activity	Frequency
Water plants regularly	As needed during first growing season
Water during dry periods	As needed after first growing season
Re-mulch void areas	As needed
Treat diseased trees and shrubs	As needed
Inspect soil and repair eroded areas	Monthly or following significant rainfall events
Remove litter and debris	Monthly
Remove and replace mulch	As needed
Maintain vegetation (pruning, tilling, weeding, re-amendment of soil)	As needed

6.6.2 Soakaway Pits

<p>Description</p> <p>A small, excavated pit, backfilled with aggregate, used to infiltrate "good quality" stormwater runoff, such as uncontaminated roof runoff or runoff from landscape or pervious areas.</p>																									
<p>Stormwater Management Suitability</p> <table border="0"> <tr> <td colspan="2">Runoff:</td> <td rowspan="2">Suitable to meet or help meet requirements for:</td> </tr> <tr> <td>Rate Control:</td> <td>Moderate</td> </tr> <tr> <td>Volume Reduction:</td> <td>High</td> <td>Water Quality Treatment through Green Infrastructure ✓</td> </tr> <tr> <td colspan="2">Implementation Considerations:</td> <td>Detention ✓</td> </tr> <tr> <td>Land Requirement:</td> <td>Moderate</td> <td></td> </tr> <tr> <td>Capital Cost:</td> <td>Low</td> <td></td> </tr> <tr> <td>Accepts Hotspot Runoff:</td> <td>No¹</td> <td></td> </tr> <tr> <td>Maintenance:</td> <td>Moderate</td> <td></td> </tr> </table>			Runoff:		Suitable to meet or help meet requirements for:	Rate Control:	Moderate	Volume Reduction:	High	Water Quality Treatment through Green Infrastructure ✓	Implementation Considerations:		Detention ✓	Land Requirement:	Moderate		Capital Cost:	Low		Accepts Hotspot Runoff:	No ¹		Maintenance:	Moderate	
Runoff:		Suitable to meet or help meet requirements for:																							
Rate Control:	Moderate																								
Volume Reduction:	High	Water Quality Treatment through Green Infrastructure ✓																							
Implementation Considerations:		Detention ✓																							
Land Requirement:	Moderate																								
Capital Cost:	Low																								
Accepts Hotspot Runoff:	No ¹																								
Maintenance:	Moderate																								
<p>Key Considerations</p> <p>Advantages:</p> <ul style="list-style-type: none"> • Can reduce the volume of runoff from a site • Can be used at sites where storm drains are not available • Provides groundwater recharge • Can be utilized in retrofit areas where space is limited <p>Limitations:</p> <ul style="list-style-type: none"> • Only applicable in small drainage areas • Not recommend for sites with high sediment loadings or contaminated runoff • Maintenance is required, typically removing sediment <p>Design:</p> <ul style="list-style-type: none"> • Typically the pit should be located close to the ground surface • A maximum storage time of 48 hours is recommended • Pits generally consist of inlet/outlet structures, geotextile fabric, clean-washed stone, and an observation well 																									

(1) Yes, if pretreatment is provided.

General Description:

Soakaway pits, also known as downspout infiltration systems, roof leader infiltration systems and dry wells, can be distinguished from infiltration trenches in terms of scale and sophistication of design. Soakaway pits are designed to receive runoff from individual roof leaders, whereas infiltration trenches are used for large-site applications (see the Infiltration Trenches section for more detail).

Soakaway pits are small, excavated pits, backfilled with aggregate, used to infiltrate “good quality” stormwater runoff, such as from uncontaminated roof runoff or landscaped (pervious) areas. Rooftop runoff is discharged to the soakaway pit through the roof leader, which extends directly into a stone-filled reservoir. Figure 6.6-3 shows an example of soakaway pit design.

The use of soakaway pits is limited by a number of site constraints, including soil type, contributing drainage area, depth to bedrock, and depth to groundwater. Consider installing rooftop gutter screens to trap particles, leaves, and other debris. If installed, they must be cleaned regularly.

Figure 6.6-3: Soakaway Pit Conceptual Drawing

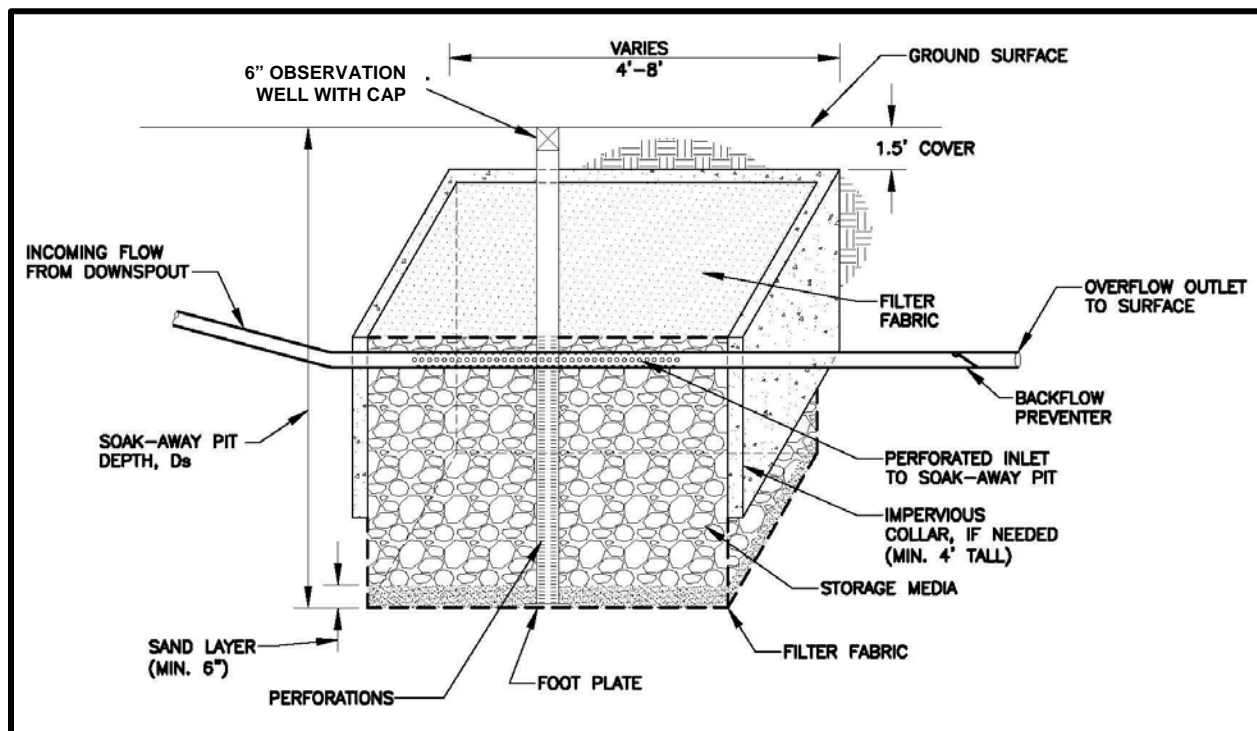

Source: MOA Low Impact Development Design Guidance Manual, 2008

Advantages:

- A. Can reduce the volume of runoff from a site, thereby reducing the size and cost of downstream stormwater control facilities.
- B. Work well for accepting runoff from individual roof leaders.
- C. The potential for clogging is reduced compared to end-of-pipe infiltration techniques (infiltration basins and trenches) because these systems generally accept runoff only from roofs, driveways, lawns, or sidewalks, which typically contain fewer suspended solids than road runoff.
- D. Can be used at sites where storm drains are not available.
- E. Can provide groundwater recharge.

Limitations:

- A. Only applicable in small drainage areas of a half acre or less (per soakaway pit).
- B. Sediment removal of pits is required to ensure the proper functioning of these systems.

However, sediment accumulation is an indication that the infiltration techniques are working. This sediment would otherwise have washed downstream to a larger water body.

- C. Not recommended for lots with high sediment loadings or contaminated runoff.
- D. If the infiltration rate of the native soils is low, these systems may not function as desired.
- E. Rain gutters downspouts and footing drains should not be tied to the same soakaway pit.
- F. Requires inspection and cleaning of rain gutters, as needed.

Design:

Site Sensitivity Analysis:

- A. Multiple soakaway pits must be horizontally separated by a distance of 20 feet unless an impervious collar is included in the design.
- B. Unlike bioretention and infiltration facilities, soakaway pits can be constructed on relatively steep slopes. Soakaway pits may be constructed on sites with slopes up to 25 percent.
- C. It is important to consider the slope of adjacent properties that are down gradient of the soakaway pit in order to limit the possibility of seepage from the subgrade to the ground surface at lower elevations. For this reason, soakaway pits should not be used when the average slope of an adjacent down gradient property is greater than 12 percent.
- D. See Section 6.2 for applicable setbacks, infiltration rates, and depth to groundwater and bedrock.

General Design Considerations:

Storage Duration-

The appropriate storage duration time depends on the function of the facility. If the facility is being used solely to meet water quality requirements (0.52 inches of rain in 24 hours), then the maximum allowable storage duration is 48 hours. A storage duration of 72 hours is allowed for runoff from rainfall depths greater than 0.52 inches, as long as it is demonstrated that sufficient volume is recovered within 48 hours for runoff from the water quality event.

Though not required, smaller, more conservative drain down times (such as 24 hours) are recommended for design in recognition of the fact that the percolation rates into the surrounding soil will decrease over time and that there will likely be a lack of maintenance in some cases.

Storage Media-

Soakaway pits are to be filled with granular material with approximately 40 percent void space such as Filter Material Type C (or equivalent) as described in MASS.

Depth-

Pit depth is the depth of the pit from the surface to the bottom of the excavation. Pit depth is a function of the design infiltration rate, the storage media porosity, and the retention time.

Storage depths greater than five feet are generally not recommended for soakaway pits from both a cost and a compaction perspective. The weight of the water in a deep soakaway pit will compact the surrounding native soil and decrease the infiltration capacity. There are exceptions, however, to this maximum depth recommendation. In areas with deep sand lenses or significant horizontal

soil stratification, deep soakaway pits may be preferred. Soils investigations should be undertaken to determine whether these situations exist.

The equation for determining pit depth is provided below:

$$D_s = \frac{I * t}{n_s * 12} + 2$$

Where:

D_s = Soakaway Pit Depth (feet)

I = Infiltration Rate (inches/hour)

t = Retention Time (hours)

n_s = Storage Media porosity (unitless)

The additional two feet added to the equation above is to allow for the use of a six–inch layer of sand in the bottom of the pit and a 1.5–foot layer over the top of the pit for cover. The sand in the bottom of the pit acts to distribute flow and to reduce localized compaction during the placement of the storage media during construction.

Typically the pit should be located close to the ground surface; however, this will depend on the depth of storage in the pit, the potential for frost heave, and the stratification of the surrounding soil media. The potential for frost heave is dependent on the surrounding native soils and the potential volume of water in the trench that can freeze.

Footprint-

The pit footprint is the plan view area of the pit, and is a function of the design pit depth, storage media porosity, and the target infiltration volume. While the exact area required for a soakaway pit can only be established through the design process, an estimate of 4% of the total contributing area is a good starting point to use during the site evaluation process. Final footprint area should be determined during design. The equation for determining the pit footprint is provided below.

$$A_s = \frac{TIV * 0.66}{n_s * (D_s - 2)}$$

Where:

A_s = Soakaway Pit Footprint (square feet)

TIV = Target Infiltration Volume (cubic feet)

n_s = Storage Media Porosity, 0.4 typical for 1.5 to three–inch stones (unitless)

D_s = Soakaway Pit Depth (feet)

The length of trench (in the direction of inflow) should be maximized compared to the width to ensure the proper distribution of water into the entire trench and to minimize the potential for groundwater mounding.

Inlet/Outlet-

Runoff enters a soakaway pit through a perforated pipe running through the top of the storage media. The perforated pipe must be at least four inches in diameter or have a cross–sectional

area no smaller than the cross-sectional area of the connected rooftop downspout. The size and spacing of perforations should be adequate to accommodate the peak runoff from the target infiltration design storm. If suitable prefabricated materials cannot be obtained, perforations can be created by drilling holes with a diameter no more than 1/4 the diameter of the inlet pipe.

Overflow structures are important for the proper design of soakaway pits. Systems should incorporate an overflow structure into the roof downspout system such that the roof downspout will drain to the surface when the soakaway pit is completely full of stormwater. Soakaway pits may incorporate an overland flow path to a stormwater collection system such that when the pit is full, flows will be directed to the collection system. All overflow structures should be designed to safely convey runoff from the 100-year, 24-hour storm event.

Impervious Collar-

Soakaway pits placed within the zone of influence road subgrades and building foundations will require the use of an impervious collar. One choice for an impervious collar is a prefabricated open-ended casing such as those commonly used in manhole construction. These prefabricated structures are commonly available in circular and square geometries and are typically constructed of reinforced concrete. Impervious collars are to be installed to a depth of four feet below the top of the storage media.

Geotextile Fabric-

Geotextile fabric selection and placement are important to both the effectiveness and the service life of a soakaway pit. Geotextile fabric that is similar to the infiltrative capacity of the soil surrounding the pit should be selected to prevent clogging. The fabric should be placed on all sides of the soakaway pit, with a minimum of one foot of overlap between separate pieces of fabric.

Observation Wells-

An observation well is to be installed in each soak-away pit. The well allows drawdown times to be monitored within the pit. The observation well will allow maintenance crews to identify when the pit has become clogged and is in need of repair. Wells should be placed to the full depth of the soak-away pit, and be secured to a footing plate. The observation well should be a minimum of 6 inches in diameter, and have a waterproof cap at the surface.

The perforated portion of the observation well should be restricted to the area within the storage media. Where the observation well passes through the filter fabric lining the top of the soak-away pit, the fabric should be sealed around the un-perforated section of the observation well.

Maintenance:

Since these structures are often installed at single-family dwellings, it is important that developers outline the maintenance requirements to property purchasers clearly.

A removable filter should be incorporated into the roof leader below the overflow pipe. The filter should have a screened bottom to prevent leaves and debris from entering the soakaway pit. It should be easy to remove so that an owner can clean the filter. Frequent use of the overflow pipe will indicate the need for filter screen maintenance.

Table 6.6-3: Summary of Maintenance Activities for Soakaway Pits

Activity	Frequency
Routine inspections (for the first few months on-line)	After each significant rainfall event
Routine inspections (after the first few months)	Twice a year
Inspect and clean rain gutters, filters, and screens	As needed or twice a year

6.6.3 Infiltration Basins

<p>Description</p> <p>A stormwater runoff impoundment designed to capture a stormwater runoff volume and infiltrate it into the ground over a period of days.</p>																									
<p>Stormwater Management Suitability</p> <table border="0"> <tr> <td colspan="2">Runoff:</td> <td rowspan="2">Suitable to meet or help meet requirements for:</td> </tr> <tr> <td>Rate Control:</td> <td>Moderate</td> </tr> <tr> <td>Volume Reduction:</td> <td>High</td> <td>Water Quality Treatment through Green Infrastructure ✓</td> </tr> <tr> <td colspan="2">Implementation Considerations:</td> <td>Detention ✓</td> </tr> <tr> <td>Land Requirement:</td> <td>High</td> <td></td> </tr> <tr> <td>Capital Cost:</td> <td>Moderate</td> <td></td> </tr> <tr> <td>Accepts Hotspot Runoff:</td> <td>No¹</td> <td></td> </tr> <tr> <td>Maintenance:</td> <td>Moderate</td> <td></td> </tr> </table>			Runoff:		Suitable to meet or help meet requirements for:	Rate Control:	Moderate	Volume Reduction:	High	Water Quality Treatment through Green Infrastructure ✓	Implementation Considerations:		Detention ✓	Land Requirement:	High		Capital Cost:	Moderate		Accepts Hotspot Runoff:	No ¹		Maintenance:	Moderate	
Runoff:		Suitable to meet or help meet requirements for:																							
Rate Control:	Moderate																								
Volume Reduction:	High	Water Quality Treatment through Green Infrastructure ✓																							
Implementation Considerations:		Detention ✓																							
Land Requirement:	High																								
Capital Cost:	Moderate																								
Accepts Hotspot Runoff:	No ¹																								
Maintenance:	Moderate																								
<p>Key Considerations</p> <p>Advantages:</p> <ul style="list-style-type: none"> • Reduces the volume of runoff from drainage area • Reduces downstream flooding and protects streambank integrity • Provides groundwater recharge and baseflow in nearby streams • Can be very effective for removing fine sediment and pollutants <p>Limitations:</p> <ul style="list-style-type: none"> • A risk of groundwater contamination may exist • Pretreatment may be required depending on anticipated sediment loading <p>Design:</p> <ul style="list-style-type: none"> • Appropriate for small sites • Requires regular maintenance • Basins typically include a settling pond, main pond, inlet/outlet structures, emergency overflow, and vegetation 																									

(1) Yes, if pretreatment is provided.

General Description:

An infiltration basin is a stormwater runoff impoundment designed to capture a stormwater runoff volume, hold this volume and infiltrate it into the ground over a period of days. It does not have a permanent pool of water. Infiltration basins are typically off-line, end-of-pipe facilities. A flow splitter or weir is often used to divert runoff from a storm drain system into the infiltration basin.

Infiltration basins require pretreatment of stormwater in order to remove as many of the suspended solids from the runoff as possible before the water enters the basin. Pretreatment, such as grit chambers, swales with check dams, filter strips, or a sedimentation basin should be a fundamental component of any system relying on infiltration. Good housekeeping measures should also be investigated (e.g., street sweeping, reduction of sanding or salting practices, etc.). Public education with respect to street and driveway sediments should be provided in areas where an infiltration basin is proposed.

Infiltration basins are not appropriate for areas that contribute high concentrations of sediment, or suspended solids, without adequate pretreatment. Excessive sediment can clog the basin and take up storage volume.

Infiltration basins are commonly used to capture small, frequent rainfall events and are often ideal for meeting stormwater treatment and extended detention requirements. Infiltration basins provide control of total peak discharge, runoff volume, and water quality for storm events equal to or less than the design event. This infiltration reduces the volume of runoff, removes many pollutants and provides stream baseflow and groundwater recharge.

When sized for small storm events, infiltration basins have limited capabilities for controlling peak discharge for larger events. Thus, these facilities are often used in conjunction with other low impact development techniques, and detention is often still needed to meet peak-runoff-rate requirements.

Dissolved pollutants are effectively controlled for storm events less than the design storm, but these substances may not be removed from the runoff water as it infiltrates, and some of them could move to the groundwater. For this reason, the impact of infiltrated runoff on the groundwater should be considered.

Figure 6.6-4 provides a schematic of a typical infiltration basin.

Advantages:

- A. Reduces the volume of runoff from a drainage area;
- B. Can be very effective for removing fine sediment, trace metals, nutrients, bacteria, and oxygen-demanding substances (organics);
- C. Reduces downstream flooding and protects streambank integrity;
- D. Reduces the size and cost of downstream stormwater control facilities and/or storm drain systems by infiltrating stormwater in upland areas;
- E. Provides groundwater recharge and baseflow in nearby streams;
- F. Reduces local flooding;
- G. Appropriate for small sites (two acres or less).

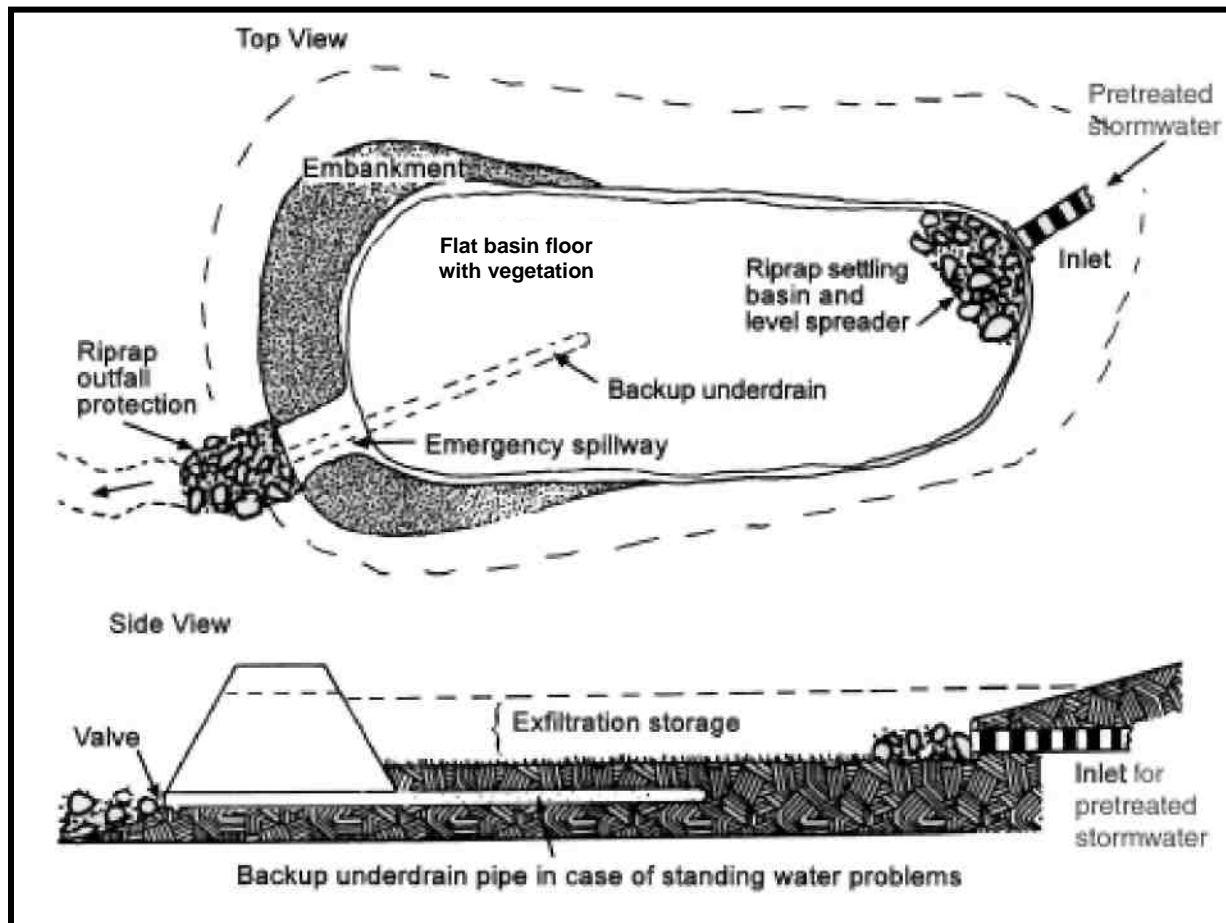
Figure 6.6-4: Typical Infiltration Basin

Modified from: *Minnesota Urban Small Sites Manual, 2001*

Limitations:

- A. Potentially high failure rates due to improper siting, design, and lack of maintenance, especially if pretreatment is not incorporated into the design;
- B. Depending on soil conditions and groundwater depth, a risk of groundwater contamination may exist;
- C. Not appropriate for treating significant loads of sediment and other pollutants due to the potential for clogging;
- D. Not appropriate for industrial or commercial sites where the release of large amounts or high concentrations of pollutants are possible;
- E. Requires a flat, continuous area; and
- F. Requires frequent inspection and maintenance.

Design:

Proper infiltration basin design requires the following considerations:

- A. Careful site selection (discussed later, in the Site Sensitivity Analysis section);

- B. Incorporation of pretreatment and a bypass for high-flow events;
- C. Treatment of a small drainage area (lower sediment loadings);
- D. Careful consideration of depth of ponding and inundation times that reflect plant tolerances;
- E. Consideration of drain-down time.
- F. Good construction techniques that prevent smearing, over-compaction, and operation of the basin during the construction period; and
- G. Performance of regular maintenance.

These considerations are discussed in further detail below.

Site Sensitivity Analysis:

Before an infiltration system can be designed, site constraints should be considered. Because of varying geologic settings, a site evaluation needs to be tailored to the specific site conditions. A team approach to this evaluation is recommended where various disciplines such as engineering, hydrogeology, and soil science are represented.

The applicability of infiltration basins depends on numerous site factors, including soils, slope, depth to groundwater table, depth to bedrock or other limiting strata, contributing watershed area, land use, proximity to wells, surface waters, foundations, and others. Generally, infiltration basins are suitable to sites with gentle slopes, permeable soils, relatively deep bedrock and groundwater levels, and a small contributing watershed area (less than two acres, ideally).

When performing a site evaluation, the following items should be considered:

- A. Size of the tributary drainage area: Although infiltration basins were originally designed to accommodate larger drainage areas, research which has been undertaken to date indicates that large-scale infiltration is not feasible. One of the main problems with centralized infiltration basins is that water from a large area is expected to infiltrate into a relatively small area. This does not reflect the natural hydrologic cycle and generally leads to problems (groundwater mounding, clogging, and compaction). For these reasons, the contributing drainage area to any individual infiltration basin should be restricted to two acres or less.
- B. Runoff water quality: If runoff water will contain a significant concentration of soluble pollutants that could contaminate groundwater, an infiltration basin should not be used. Specifically, infiltration basins are not recommended for industrial and commercial land uses since there is a high potential for groundwater contamination from chemical spills and maintenance activities, such as sanding, etc. In site-specific cases where infiltration basins are deemed acceptable for these land uses, the design must be located off-line and incorporate some form of upstream treatment.
- C. Degree of detail: The level of detail required for the study should be considered. For instance, a small structure receiving runoff from a rooftop will not require as much detail as a structure serving a larger area and having a higher potential pollutant load.
- D. Geologic (groundwater) sensitivity: A site with a highly sensitive geology, such as one with a carbonate or surficial sand aquifer, may eliminate this practice from consideration.
- E. The ground slope at the infiltration basin must be less than or equal to 15 percent.

- F. Average slope of adjacent down gradient property must be less than 20 percent.
- G. See Section 6.2 and Table 6.4-1 for applicable setbacks, infiltration rates, and depth to groundwater and bedrock.

General Design Considerations:

Off-Line Placement-

The purpose of the basin is to temporarily store surface runoff for a specific design frequency storm and allow it to infiltrate through the bottom and sides of the basin. A flow splitter or weir is usually used to divert runoff into an off-line infiltration basin. Infiltration basins provide total peak discharge, runoff volume and water quality control for all storm events equal to or less than the design storm. Storm events greater than the design storm simply continue down the larger conveyance system, bypassing the infiltration basin.

Pretreatment-

Infiltration basins are susceptible to high failure rates due to clogging from sediments, and therefore require pretreatment of stormwater in order to remove as much of the suspended solids from the runoff as possible before it enters the basin. Pretreatment, such as grit chambers, swales with check dams, filter strips, or sediment forebays/traps should be a fundamental component of any system relying on infiltration. Even when infiltrating rooftop runoff, it is a practical decision to implement some form of pretreatment to remove sediments, leaf litter, and debris. This pretreatment will help to ensure the proper functioning of the infiltrating facility and allow for longer periods between maintenance.

Duration of Ponding-

The design of the infiltration facility, including the facility depth, should be adjusted so that the facility meets drain down requirements. If the facility is being used solely to meet water quality requirements (0.52 inches of rain in 24 hours), then the maximum allowable ponding duration is 48 hours. A ponding duration of 72 hours is allowed for runoff from rainfall depths greater than 0.52 inches, as long as it is demonstrated that sufficient volume is recovered within 48 hours for runoff from the water quality event.

Certain types of vegetation (turf, for example) will require shorter ponding duration to survive storm events. See vegetation section below for further detail.

Average Depth-

After the infiltration rate of the soil has been determined, the maximum depth of the infiltration basin can be calculated with the following equation:

$$D_s = \frac{I * t}{12}$$

Where:

D_s = Depth (feet)

I = Soil Infiltration Rate (inches/hour)

t = Retention Time (hours)

The maximum depth and ponding time of the infiltration area should promote the survival of vegetation. Also, the weight of the water is thought to compact the basin, decreasing its infiltration potential. The depth of storage should be limited to a maximum two feet in order to minimize the compaction of the basin.

Footprint-

The footprint is the plan view area of the pond, and is a function of the basin depth and the target infiltration volume. The equation for determining the footprint is provided below.

$$A_s = \frac{TIV * 0.66}{D_s}$$

Where:

A_s = Footprint (square feet)

TIV = Target Infiltration Volume (cubic feet)

D_s = Depth (feet)

Basin Slopes-

The bottom of the basin should be graded as flat as possible to provide uniform ponding and infiltration of the runoff across the floor. The side slopes of the basin shall meet the requirements of Section 6.5 Stormwater Pond Safety Considerations. Generally, shallower slopes are preferred. Slopes must allow for public safety, proper vegetative stabilization, and mowing or other vegetation maintenance. Designs for infiltration basins should emphasize accessibility and ease of maintenance.

Basin Shape-

The length and width of the basin will be determined by the characteristics of the site in question (topography, size and shape).

Vegetation-

A key feature of an infiltration basin is its vegetation. It is important to vegetate the bottom of the basin with deep-rooted plants to increase the infiltration capacity of the basin. Roots create small conduits for water to infiltrate. The root penetration and thatch formation of the vegetation maintains and may enhance the original infiltration capacity. Soluble nutrients are taken up during plant growth, improving the pollutant-removal capacity of the basin. Dense vegetation will also impede soil erosion and scouring of the basin floor.

Immediately following basin construction, the bottom and side slopes of the basin should be stabilized with a dense stand of water-tolerant grass. Likewise, vegetative buffers around the perimeter of the basin are recommended for erosion control and additional sediment and nutrient removal. A diversity of plant species should be planted to allow for best survivability. Plants that are tolerant of both wet weather and drought should be used. Plantings in an infiltration basin should be able to withstand periods of ponding and maintain or enhance the pore space in the underlying soils. Additional guidance with selecting non-invasive plant species appropriate for infiltration basins is presented in Appendix E.

Inflow

If runoff is delivered by a storm drain pipe or along the main conveyance system, the infiltration practice must be designed as an off-line practice.

To prevent incoming flow velocities from reaching erosive levels, which can scour the basin floor, inlet channels to the basin should be stabilized. Riprap may be used for this purpose. The riprap should be designed to terminate in a broad apron, which spreads the runoff more evenly over the basin surface to promote better infiltration.

Pond inlets should discharge at an elevation such that the inlet will not be fully submerged during a storm event and should be buried below the frost penetration depth, or insulated to prevent freezing.

Overflow/Bypass--

All infiltration basins must have an overflow or bypass capable of passing runoff from events larger than the facility's design event. A bypass design may necessitate the construction of a flow splitter upstream of the basin. The bypass serves several functions. Specifically, the bypass can be used as the normal outlet during (1) stabilization of the site (while the inlet to the basin is blocked off), (2) basin maintenance and (3) winter conditions.

If an overflow is incorporated, the overland flow path of surface runoff exceeding the capacity of the infiltration system should be evaluated to eliminate erosion due to concentrated flow. If computed flow velocities do not exceed the non-erosive threshold, overflow may be accommodated by natural topography. Downstream impacts must be considered with overflow structures.

Safety-

Protective fences are required for any basins with side slopes steeper than 4:1 and a water depth greater than one foot at any time. Other considerations for safety include the placement of warning signs, a safety ledge graded around the pond perimeter, and low, dense planting of thorny, noninvasive shrubs.

Groundwater Mounding-

Calculations to determine groundwater mounding may be necessary in cases where slope stability is a concern and/or a high water table is encountered. A hydrogeologist should be consulted about the potential for groundwater mounding in these areas. The results from groundwater mounding calculations should be regarded as an indication of the mounding potential rather than as an accurate representation of the actual mounding depth.

Construction and Sequencing:

Care should be taken during construction to minimize the risk of premature failure of the infiltration basin. This failure is caused by the deposition of sediments from disturbed, unstabilized areas. This can be minimized or avoided by proper sequencing and construction.

- A. Ideally, construction of the infiltration basin should take place after the site has been stabilized.
- B. In order to avoid soil compaction, absolutely no equipment should be driven in the area of the basin before and after its construction.

- C. Before the development site is graded, the area of infiltration basin should be roped off to prevent heavy equipment from compacting the underlying soils.
- D. No runoff should enter the infiltration basin prior to completion of construction and the complete stabilization of the tributary areas.
- E. Diversion berms or silt fence should be placed around the perimeter of the infiltration basin during all phases of construction. Sediment and erosion controls should be used to keep runoff and sediment away from the infiltration basin.
- F. Initial excavation of the basin should be carried out to within one foot of the final grade of the basin floor. Final excavation of the basin floor should be delayed until all disturbed areas in the drainage area are stabilized.
- G. All excavation should be performed by equipment with tracks exerting relatively light pressures. This will prevent compacting of the basin floor, which would reduce the infiltration capacity.
- H. After final grading, the basin floor should be tilled to a depth of at least six inches to provide a well-aerated, porous surface texture. Six inches of compost should be tilled in at this time if soils are even the slightest bit compacted. This will help to facilitate infiltration and root growth.
- I. During and after excavation, all excavated materials should be placed downstream, away from the infiltration basin, to prevent redepositing during runoff events.
- J. Immediately following basin construction, the bottom and side slopes of the basin should be stabilized with a dense stand of appropriate plants.
- K. Infiltration basins should not be used as temporary sediment traps during construction.
- L. Smearing of the soil at the interface with the basin floor must be avoided and/or corrected by raking or scarifying.

Maintenance:

Maintenance is required for the proper operation of infiltration basins. Plans for infiltration basins should identify owners, parties responsible for maintenance, and an inspection and maintenance schedule. The use and regular maintenance of pretreatment systems will significantly minimize maintenance requirements for the basin. Recommended maintenance activities are also presented in Table 6.6-4.

- A. Pretreatment devices associated with basins should be inspected and cleaned at least twice a year, and ideally every other month. For those cleaned only twice a year, spring cleaning after snowmelt is recommended due to sediment accumulation from sanding operations.
- B. Once the basin has gone on-line, inspections should occur after each significant rainfall for the first few months to ensure proper stabilization and function. Attention should be paid to how long water remains standing in the basin after a storm; standing water within the basin more than 48 to 72 hours (depending on the design ponding duration) after a storm indicates that the infiltration capacity may have been overestimated. Factors responsible for clogging (such as upland sediment erosion and excessive compaction of soils) should be repaired immediately. Also, the newly established vegetation should be inspected several times to determine if any remedial actions (reseeding, irrigation, etc.) are necessary.
- C. Thereafter, the infiltration basin should be inspected at least twice per year. Important items to check include: differential accumulation of sediment, erosion of the basin floor, condition of riprap and the health of the vegetation. Eroded or barren spots should be replanted

immediately after inspection to prevent additional erosion and accumulation of sediment.

- D. Sediment removal within the basin should be performed when the sediment is dry enough so that it is cracked and readily separates from the basin floor. This also prevents smearing of the basin floor.
- E. Light equipment, which will not compact the underlying soil, should be used to remove the top layer of sediment. The remaining soil should be tilled and revegetated as soon as possible.
- F. Vegetation should be maintained to control weed growth and maintain the health of the vegetation in the basin. Weed once monthly during the first two growing seasons. After that, weeding two or three times per growing season may suffice.

Table 6.6-4: Summary of Maintenance Activities for Infiltration Basins

Activity	Frequency
Inspect and clean pretreatment devices	Twice a year
Routine inspections (for the first few months on-line)	After each significant rainfall event
Routine inspections (after the first few months)	Twice a year
Sediment removal	As needed - when dry, cracked, and separating from basin floor
Weeding (within first few growing seasons)	Monthly
Weeding (after first few growing seasons)	Two or three times per growing season

6.6.4 Infiltration Trenches

<p><u>Description</u></p> <p>An excavated trench filled with stone aggregate used to capture and allow infiltration of stormwater runoff into the surrounding soils from the bottom and sides of the trench.</p>																									
<p><u>Stormwater Management Suitability</u></p> <table> <tr> <td colspan="2">Runoff:</td> <td rowspan="2">Suitable to meet or help meet requirements for:</td> </tr> <tr> <td>Rate Control:</td> <td>Moderate</td> </tr> <tr> <td>Volume Reduction:</td> <td>High</td> <td>Water Quality Treatment through Green Infrastructure ✓</td> </tr> <tr> <td colspan="2">Implementation Considerations:</td> <td>Detention ✓</td> </tr> <tr> <td>Land Requirement:</td> <td>Moderate</td> <td></td> </tr> <tr> <td>Capital Cost:</td> <td>Moderate</td> <td></td> </tr> <tr> <td>Accepts Hotspot Runoff:</td> <td>No¹</td> <td></td> </tr> <tr> <td>Maintenance:</td> <td>Moderate</td> <td></td> </tr> </table>			Runoff:		Suitable to meet or help meet requirements for:	Rate Control:	Moderate	Volume Reduction:	High	Water Quality Treatment through Green Infrastructure ✓	Implementation Considerations:		Detention ✓	Land Requirement:	Moderate		Capital Cost:	Moderate		Accepts Hotspot Runoff:	No ¹		Maintenance:	Moderate	
Runoff:		Suitable to meet or help meet requirements for:																							
Rate Control:	Moderate																								
Volume Reduction:	High	Water Quality Treatment through Green Infrastructure ✓																							
Implementation Considerations:		Detention ✓																							
Land Requirement:	Moderate																								
Capital Cost:	Moderate																								
Accepts Hotspot Runoff:	No ¹																								
Maintenance:	Moderate																								
<p><u>Key Considerations</u></p> <p>Advantages:</p> <ul style="list-style-type: none"> • Can be utilized where space is limited, due to their narrow dimensions • Reduces downstream flooding and protects streambank integrity • Provides groundwater recharge and baseflow in nearby streams • Reduces the size and cost of downstream stormwater control facilities <p>Limitations:</p> <ul style="list-style-type: none"> • Avoiding groundwater contamination must be considered • Pre-treatment for sediment removal is required • Requires frequent inspection and maintenance <p>Design:</p> <ul style="list-style-type: none"> • Best suited for draining small areas • Best applied to areas with well-draining soils • Trenches commonly consist of a pre-treatment element, geotextile fabric liner, storage media layer, and observation well 																									

(1) Yes, if runoff pretreatment is provided.

General Description:

Infiltration trenches are shallow (4 to 10-foot) excavations that are lined with geotextile fabric and filled with stone to create underground reservoirs for stormwater runoff from a specific design storm. The runoff gradually percolates through bottom and sides of the trench into the surrounding subsoil over a period of days. Infiltration trenches are typically implemented at the ground surface to intercept overland flows.

Runoff can be captured by depressing the trench surface or by placing a berm at the down gradient side of the trench.

In this section, infiltration trenches refer to surface trenches that collect sheet flow from a few lots or properties as opposed to soakaway pits which are primarily used for a single lot application.

Infiltration trenches require pretreatment of stormwater in order to remove as much of the suspended solids from the runoff as possible before it enters the trench. Pretreatment practices, such as grit chambers, swales with check dams, filter strips, or sediment forebays/traps should be a fundamental component of any system relying on infiltration. Source controls should also be investigated (e.g., eliminate excessive sanding/salting practices). Public education with respect to street/driveway sediments should be provided in areas where an infiltration trench is proposed.

Infiltration trenches can provide total peak discharge, runoff volume and water quality control for all storm events equal to or less than the storm the facility is designed for. This infiltration reduces the volume of runoff, removes many pollutants and provides stream baseflow and groundwater recharge.

Infiltration trenches have limited capabilities for controlling peak discharge for storms greater than their design storm. They can be best used in conjunction with other low impact development techniques to control higher peak flows. Downstream detention is often still needed to meet peak runoff rate requirements.

Dissolved pollutants are effectively controlled for storm events less than the design storm, but these substances may not be removed from the runoff water as it infiltrates, and a portion could move to the groundwater. For this reason, separation from groundwater is required as specified in Section 6.2 and Table 6.4-1.

Figure 6.6-5 on the following page provides a schematic of a typical infiltration trench.

Advantages:

- A. Reduces the volume of runoff from a drainage area;
- B. Can be very effective for removing fine sediment, trace metals, nutrients, bacteria, and oxygen-demanding substances (organics);
- C. Reduces downstream flooding and protects streambank integrity;
- D. Reduces the size and cost of downstream stormwater control facilities and/or storm drain systems by infiltrating stormwater in upland areas;
- E. Provides groundwater recharge and baseflow in nearby streams;
- F. Reduces local flooding;
- G. Can be utilized where space is limited, due to their narrow dimensions.

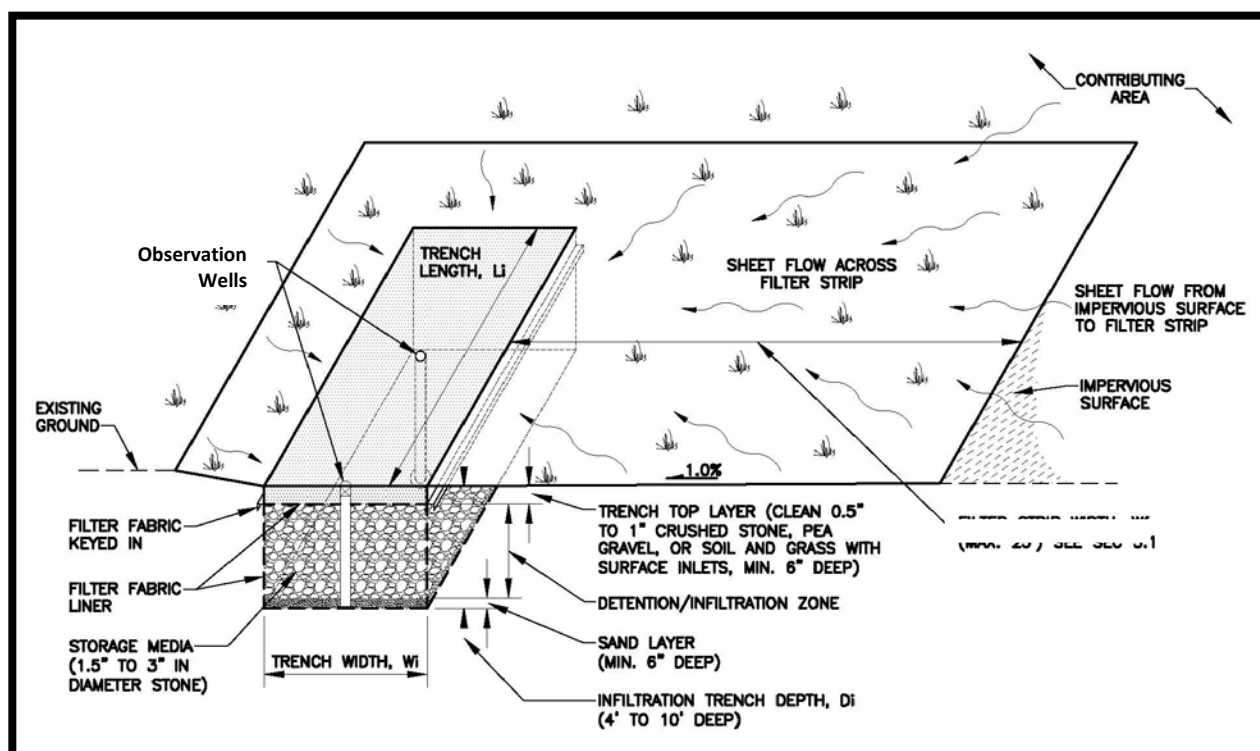
Figure 6.6-5: Infiltration Trench Conceptual Drawing**Limitations:**

- A. Potential failure due to improper siting, design and lack of maintenance, especially if pretreatment is not incorporated into the design.
- B. Depending on soil conditions, land use in the watershed, and groundwater depth, a risk of groundwater contamination may exist.
- C. Not appropriate for industrial or commercial sites where the release of large amounts or high concentrations of pollutants is possible.
- D. Susceptible to clogging by sediment, resulting in frequent maintenance.
- E. Requires frequent inspection and maintenance.

Design:

To avoid infiltration trench failure, the following topics into should be considered during design:

- A. Careful site selection (discussed further in the Site Sensitivity Analysis section);
- B. Treatment of sheet flow from a small drainage area;
- C. Incorporation of pretreatment and a bypass for high flow events;
- D. Good construction techniques that prevent smearing, over-compaction, and operation of the trench during the construction period; and
- E. Performance of regular maintenance.

All of these topics are discussed in further detail below.

Site Sensitivity Analysis

Before an infiltration system can be designed, site constraints should be considered. Because of varying geologic settings, a site evaluation needs to be tailored to the specific site conditions. A team approach to this evaluation is recommended where various disciplines such as engineering, hydrogeology, and soil science are represented.

The applicability of infiltration trenches depends on numerous site factors including, soils, slope, depth to water table, depth to bedrock or impermeable layer, contributing watershed area, land use, proximity to wells, surface waters, foundations, and others. Generally, infiltration trenches are suitable to sites with gentle slopes, permeable soils, relatively deep bedrock and groundwater levels, and a small contributing watershed area (less than three acres, ideally).

When performing a site evaluation, the following items should be considered:

- A. Runoff water quality: If runoff water will contain a significant concentration of soluble pollutants that could contaminate groundwater, an infiltration trench should not be used. Specifically, infiltration trenches are not recommended for industrial and commercial land uses where there is a high potential for groundwater contamination from chemical spills. In site specific cases where infiltration trenches are deemed acceptable for these land uses, the design must incorporate some form of upstream pretreatment.
- B. Degree of detail: The level of detail required for the study should be considered. For instance, a small structure receiving runoff from a rooftop will not require as much detail as a structure serving a larger area and having a higher potential pollutant load.
- C. Geologic (groundwater) sensitivity: A site with a highly sensitive geology, such as one with a carbonate or surficial sand aquifer, may eliminate this practice from consideration.
- D. Soil infiltration rate: The infiltration rate of the soil must be great enough to drain the structure in a reasonable amount of time, generally 48 hours or less. Note that if the facility is being sized to contain only the runoff volume from the first 0.52 inches of rainfall (per the Green Infrastructure stormwater treatment requirement), this 48 hours assumes the entire volume arrives at the facility at one time. If the facility is being designed to accommodate an inflow hydrograph in addition to the required volume per Stormwater Management Requirement 2, then this 48 hours is from the beginning of runoff. See Section 6.2 for additional information regarding acceptable infiltration rates.
- E. Size of the contributing drainage area: Although infiltration trenches were originally designed to accommodate larger drainage areas, the monitoring which has been undertaken to date indicates that large scale infiltration is not feasible. One of the main problems with centralized infiltration trenches is that water from a large area is expected to infiltrate into a relatively small area. This does not reflect the natural hydrologic cycle and generally leads to problems (groundwater mounding, clogging, and compaction). For these reasons, the contributing drainage area to any individual infiltration trench should be restricted to three acres or less.
- F. The ground slope at the infiltration trench must be less than or equal to 15 percent.
- G. Average slope of adjacent down gradient property must be less than 20 percent.
- H. See Section 6.2 and Table 6.4-1 for applicable setbacks, and depth to groundwater and bedrock.

General Design Considerations:

Pretreatment-

Infiltration trenches are susceptible to high failure rates due to clogging from sediments, and therefore require pretreatment of stormwater in order to remove as much of the suspended solids from the runoff as possible before it enters the trench. In locations where runoff is from roadways, parking lots, or other locations where high sediment loads are expected, pretreatment shall be incorporated as applicable. Pretreatment may include grit chambers, swales with check dams, filter strips, or sediment forebays/traps, etc. Even when infiltrating rooftop runoff, it is practical to implement some form of pretreatment to remove sediments, leaf litter, and debris. This pretreatment will help to ensure the proper functioning of the infiltrating facility and allow for longer periods between maintenance.

Designs for infiltration trenches should emphasize accessibility and ease of maintenance.

Duration of Ponding-

The appropriate trench drain-town time depends on the function of the facility. If the facility is being used solely to meet water quality requirements (0.52 inches of rain in 24 hours), then the maximum allowable storage duration is 48 hours. A storage duration of up to 72 hours is allowed for runoff from rainfall depths greater than 0.52 inches, as long as it is demonstrated that sufficient volume is recovered within 48 hours for runoff from the water quality event.

Storage Media-

The basic infiltration trench design utilizes stone aggregate in the top of the trench to provide storage. The trench should be filled with a granular material with approximately 40 percent void space, such as Filter Material Type C as specified in MASS or equivalent. This aggregate size provides a void space of approximately 40 percent.

It should be noted that while stone is the most common form of storage media in infiltration trenches, there are suppliers that manufacture precast infiltration storage media. These alternative storage media solutions are generally acceptable and should be reviewed and implemented on a case by case basis until there is adequate research/experience with their performance.

Trench Depth-

Trench depths are usually between 4 and 10 feet. Infiltration trenches can be constructed to be deeper than this for certain site characteristics. The maximum effective depth is defined as the depth to which the design volume of runoff actually fills the trench. A site specific, maximum effective trench depth can be calculated based on the soil infiltration rate, aggregate void space, and the trench storage time.

$$D_i = \frac{I * t}{n_s * 12}$$

Where:

D_i = Storage Media Depth (feet)

I = Design Soil Infiltration Rate (inches/hour)

t = Retention Time (hours)

n_s = Void Ratio of Storage Media

The facility depth in the equation above is the depth of the storage media or the main treatment depth, which is different from the total facility depth because it does not include the top and bottom layers. If six inches of sand or pea gravel are added to the top and bottom of the trench (see discussions of top and bottom layers in this section) then an additional one foot should be added to obtain the total facility depth.

Trench Volume and Configuration-

The volume and surface area of an infiltration trench relate to the design volume of runoff entering the trench from the contributing watershed and the permeability of the soil below the trench. In addition, since the infiltration trench is filled with stone, only the space between the stone (hereafter called the void space in the storage media) is available for runoff storage.

The length and width of the trench will largely be determined by the characteristics of the site in question (topography, size and shape). The designer should consider the potential for this facility to be classified as a Class V injection well when selecting these dimensions. The dimensions of the trench will also depend on the path of influent water. If stormwater is conveyed to the trench as uniform sheet flow, the length of the trench perpendicular to the flow direction should be maximized. If stormwater is conveyed as channel flow, the length of trench parallel to the direction of flow should be maximized. The width of a trench can be adjusted to meet site constraints as long as the necessary footprint area is maintained. The minimum suggested length to width ratio to be applied to an infiltration trench design is 3:1. The maximum allowable trench width, parallel to flow, is 25 feet.

The appropriate bottom area of the trench can be calculated using the equation shown below. This equation assumes that all of the infiltration occurs through the bottom of the trench. The depth in this equation is the storage media depth from the equation above and does not include the top and bottom layers.

$$A_i = \frac{TIV}{n_s * (D_i)}$$

Where:

A_i = Trench Footprint (square feet)

TIV = Target Infiltration Volume (cubic feet)

n_s = Void Ratio of Storage Media

D_i = Storage Media Depth (feet)

Geotextile Fabric-

The sides and bottom of the infiltration trench shall be lined with geotextile fabric. Also, there can be a layer geotextile fabric 6 to 12 inches below the ground surface to prevent suspended solids from clogging the majority of the storage media. It should be recognized, however, that there may be a need to frequently replace this geotextile fabric layer depending on the volume of suspended solids transported to the trench.

The geotextile fabric material must be compatible with the surrounding soil textures and application purposes. The cut width of the geotextile fabric must have sufficient material for a minimum 12-inch overlap. When overlaps are required between rolls, the upstream roll must lap a minimum of two feet over the downstream roll to provide a shingled effect. The bottom of the infiltration trench can be covered with a 6 to 12-inch layer of clean sand in place of geotextile fabric.

Observation Well-

An observation well is to be installed in each infiltration trench. An additional observation well should be installed for every 50 linear feet of infiltration trench. Observation wells allow drawdown times to be monitored within the trench, and will allow maintenance crews to identify when the trench has become clogged and is in need of repair. The wells should be placed to the full depth of the trench and be secured to a footing plate. The observation well should be a minimum of six inches in diameter and have a waterproof cap at the surface.

The perforated portion of the observation well should be between the top and bottom layers of geotextile fabric. Where the observation well passes through the top layer of geotextile fabric, the geotextile fabric should be sealed around the un-perforated section of the well. This will limit the intrusion of sediments collected by the upper geotextile fabric into the lower portion of the well, where they are more difficult to remove.

Top Layer-

Infiltration trenches can be covered with a variety of different materials. The top layer is intended to provide cover for the first layer of geotextile fabric and to provide a level surface that can be easily traversed. An additional benefit of the top layer is improvement of aesthetics. The top layer of an infiltration trench should consist of a minimum of six inches of one of the following: clean crushed stone, pea gravel, or soil and grass. Note, that if a grass cover is used, sufficient surface inlets into the infiltration trench must also be installed. Due to the need for periodic maintenance, infiltration trenches should not be covered with concrete or asphalt.

Bottom Layer-

A bottom layer consisting of six inches of clean sand or pea gravel should be considered to evenly distribute flows along the bottom of the trench and to protect the underlying soil from localized compaction during placement of the storage media.

Bypass-

An bypass or overflow structure should be provided to convey flow from storms larger than the event the facility is designed to accommodate. A bypass flow path should be incorporated in the design of an infiltration trench to convey flows higher than the design flow around the trench.

The overland flow path of surface runoff exceeding the capacity of the infiltration trench should be evaluated to preclude erosive concentrated flow. If computed flow velocities do not exceed the non-erosive threshold, overflow may be accommodated by natural topography. All overflow designs must be in accordance with the downstream capacity requirements discussed in Section 3.

Groundwater Mounding-

Calculations to determine groundwater mounding (local elevation of the water table as a result of infiltrated surface water) may be necessary in cases where slope stability is a concern, and/or a high water table is encountered. A hydrogeologist should be consulted with respect to the potential for groundwater mounding in these areas. The results from groundwater mounding calculations should be regarded as an indication of the mounding potential rather than as an accurate representation of the actual mounding depth.

Construction and Sequencing:

Experience has shown that the longevity of infiltration practices is strongly influenced by the care taken during construction. The construction sequence and specifications for each infiltration practice must be precisely followed.

Care should be taken during construction to minimize the risk of premature failure of the infiltration trench. This failure is caused by the deposition of sediments from disturbed, unstabilized areas. This can be minimized or avoided by proper construction and sequencing.

- A. Ideally, construction of the infiltration trench should take place at the end of site development, after the site has been stabilized.
- B. Before the development site is graded, the area of infiltration trench should be protected with temporary construction fencing to prevent heavy equipment from compacting the underlying soils.
- C. Diversion berms or silt fence should be placed around the perimeter of the infiltration trench during all phases of construction. Sediment and erosion controls should be used to keep runoff and sediment away from the infiltration trench.
- D. Heavy equipment should not operate on the surface location where the infiltration trenches are planned. Soil compaction will adversely affect the performance of the trench, and infiltration trench sites should be roped off and flagged. During excavation and trench construction, only light equipment such as backhoes or wheel and ladder type trenchers should be used to minimize compaction of the surrounding soils.
- E. During and after excavation, all excavated materials should be placed downstream, away from the infiltration trench, to prevent redepositing during runoff events.
- F. Infiltration trenches should not be used as temporary sediment traps during construction. Infiltration trenches will only operate as designed if they are constructed properly.
- G. Smearing of the soil at the interface with the trench bottom and sides must be avoided. Smearing of the trench bottom can be corrected by raking or scarifying.

Maintenance:

Maintenance is required for the proper operation of infiltration trenches. Plans for infiltration trenches should identify owners, parties responsible for maintenance, and an inspection and maintenance schedule.

- A. The use of pretreatment systems will significantly minimize maintenance requirements of the trench itself. Removing accumulated sediment from a sump pit or a vegetated swale is considerably less difficult and less costly than rehabilitating a trench. Eventually, the infiltration trench should be rehabilitated, but this time span is relative to the effective performance of the trench. With appropriate design and aggressive preventive maintenance, this rehabilitation may not be necessary for a decade or more.
- B. Once the trench has gone online, inspections should occur after each significant rainfall for the first few months to ensure proper stabilization and function. Water levels in the observation well should be recorded over several days to check trench drainage.
- C. After the first few months of operation, the infiltration trench should be inspected at least twice per year. Important items to check for include: accumulated sediment, leaves and debris in the pretreatment device, clogging of inlet and outlet pipes and ponded water both inside and on the surface of the infiltration trench.
- D. When ponding occurs at the surface or in the trench, corrective maintenance is required immediately.
- E. Clogging in trenches occurs most frequently on the surface. Grass clippings, leaves, and accumulated sediment should be removed routinely from the surface of the trench. If the clogging appears only to be at the surface, it may be necessary to remove and replace the first layer of stone aggregate and the geotextile fabric.
- F. Ponded water inside the trench (as visible from the observation well) after the design ponding duration often indicates that the bottom of the trench is clogged, indicating a percolation failure from the bottom. In this case, all of the stone aggregate and geotextile fabric or media must be removed. Accumulated sediment should be stripped from the trench bottom. At this point, the bottom may be tilled to help induce infiltration. New fabric and clean stone aggregate should be refilled.
- G. Pretreatment devices associated with trenches should be inspected and cleaned at least twice a year. At a minimum, pre-treatment facilities should be cleaned shortly after spring snowmelt due to heavy sediment load from sanding.

Table 6.6-5: Summary of Maintenance Activities for Infiltration Trenches

Activity	Frequency
Routine inspections (for the first few months on-line)	After each significant rainfall
Routine inspections (after the first few months)	Twice a year
Remove grass clippings, leaves, and accumulated sediments on surface of trench	Minimum of annually or as needed
Inspect and clean pretreatment devices	Twice a year

6.6.5 Vegetated Swales

<p><u>Description</u></p> <p>Vegetated open channels that are explicitly designed and constructed to treat stormwater runoff within dry or wet cells formed by check dams or other means.</p>																									
<p><u>Stormwater Management Suitability</u></p> <table border="0"> <tr> <td colspan="2">Runoff:</td> <td rowspan="2">Suitable to meet or help meet requirements for:</td> </tr> <tr> <td>Rate Control:</td> <td>Moderate</td> </tr> <tr> <td>Volume Reduction:</td> <td>Moderate</td> <td>Water Quality Treatment through Green Infrastructure ✓</td> </tr> <tr> <td colspan="2">Implementation Considerations:</td> <td>Detention ✓</td> </tr> <tr> <td>Land Requirement:</td> <td>Moderate</td> <td>Pretreatment ✓</td> </tr> <tr> <td>Capital Cost:</td> <td>Low</td> <td></td> </tr> <tr> <td>Accepts Hotspot Runoff:</td> <td>No¹</td> <td></td> </tr> <tr> <td>Maintenance:</td> <td>Low</td> <td></td> </tr> </table>			Runoff:		Suitable to meet or help meet requirements for:	Rate Control:	Moderate	Volume Reduction:	Moderate	Water Quality Treatment through Green Infrastructure ✓	Implementation Considerations:		Detention ✓	Land Requirement:	Moderate	Pretreatment ✓	Capital Cost:	Low		Accepts Hotspot Runoff:	No ¹		Maintenance:	Low	
Runoff:		Suitable to meet or help meet requirements for:																							
Rate Control:	Moderate																								
Volume Reduction:	Moderate	Water Quality Treatment through Green Infrastructure ✓																							
Implementation Considerations:		Detention ✓																							
Land Requirement:	Moderate	Pretreatment ✓																							
Capital Cost:	Low																								
Accepts Hotspot Runoff:	No ¹																								
Maintenance:	Low																								
<p><u>Key Considerations</u></p> <p>Advantages:</p> <ul style="list-style-type: none"> • Combines stormwater treatment with runoff conveyance • Less expensive than curb and gutter • Reduces runoff velocity <p>Limitations:</p> <ul style="list-style-type: none"> • Cannot be used on steep slopes • Possible re-suspension of sediment • Potential for odor or mosquitoes <p>Design:</p> <ul style="list-style-type: none"> • Check dams may be included into the design to increase infiltration • Vegetative swales generally consist of vegetation, substrate, a flow bypass, inlet and outlet, check dams and maintenance access. 																									

(1) Yes, if impermeable liner is included or if pretreatment is provided.

General Description:

Vegetated swales are conveyance channels engineered to treat a runoff volume for a drainage area. They differ from a normal drainage channel or swale through the incorporation of specific features that enhance stormwater pollutant removal effectiveness.

Vegetated swales are designed with limited longitudinal slopes to force the flow to be slow and shallow, thus allowing for particulates to settle and limiting the effects of erosion. Berms and/or check dams installed perpendicular to the flow path promote settling and infiltration. A conceptual layout is shown in

Figure 6.6-6.

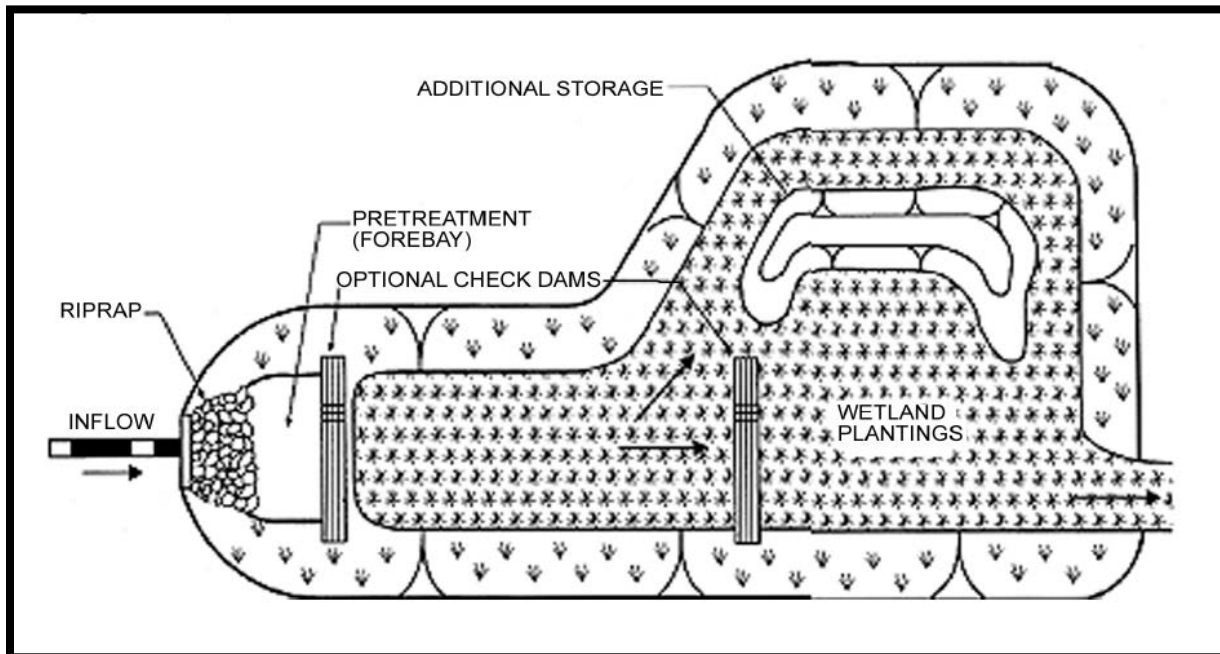
Figure 6.6-6: Vegetated Swale Conceptual Layout

Source: *Minnesota Urban Small Sites Manual, 2001*

Advantages:

- A. Control of peak discharges by reducing runoff velocity and promoting infiltration.
- B. Provide effective pretreatment by trapping, filtering, and infiltrating pollutants.
- C. Accent natural landscape.
- D. Reduce peak flows.
- E. Increase pollutant removal efficiency.
- F. Promote runoff infiltration.
- G. Offer lower capital costs than traditional storm drain system.
- H. Convey water in properly protected channels.
- I. Divert water around potential pollutant sources.
- J. Provide water quality treatment by sedimentation and biological uptake.
- K. Enhance biological diversity and create beneficial habitat between upland and surface waters.

Limitations:

- A. Impractical in areas with very flat grades, steep topography, or wet or poorly drained soils.
- B. May erode when flow volumes and/or velocities are high during storm events.
- C. Area requirements can be excessive for highly developed sites.
- D. Roadside swales become less feasible as the number of driveway entrances requiring culverts increases.

Design:*Shape and Slope:*

Vegetated swales should generally be trapezoidal in shape, with a bottom width ranging from 2 to 8 feet. The side slopes of the channel should be no steeper than 3:1 for maintenance and safety considerations. Flatter slopes are encouraged where adequate space is available to aid in providing pretreatment for lateral flows.

The slope of a vegetated swale should not exceed 6 percent and slopes in excess of 4 percent will likely require check dams. The actual swale dimensions are determined based on the design rainfall event, the site topography, and other site specific conditions. To provide flexibility for designers, there are two allowable design procedures for vegetated swales.

Design Procedure Option 1:

This method uses a runoff flow rate for the swale design. The runoff flow rate should be determined using the Rational Method (see Section 3) for the water quality design event. The estimated peak intensity for the water quality event for vegetated swale design is 0.12 inches/hour. Manning's equation should then be used to determine flow velocity.

The length of the swale should be sufficient to provide hydraulic residence time at the design velocity. The maximum allowable velocity for vegetated swales is 1.0 fps. In order to provide adequate treatment, 100 feet is recommended as a minimum length. The swale length should be calculated for a travel time of five to nine minutes. A wide-radius curved path may be used to gain length where land is not adequate for a linear swale, but sharp bends must be avoided.

If the design velocity cannot be achieved within the allowable slope limits, check dams can be installed to slow the velocity. If check dams are used for this purpose, space the check dams according to the table below. Place the first check dam 20 feet downstream of the inflow point. If the swale is also intended for conveyance, the designer is responsible for ensuring that check dams do not hinder adequate conveyance. Details regarding gravel check dam design is presented in Section 6.7. In addition to gravel, the check dam may also be constructed of:

- A. Riprap with 2:1 side slopes,
- B. Plants suitable for Reed and Softwood zone plantings (plantings two to three feet in width can adequately slow velocity of water while naturalizing the appearance of the vegetated swale),
- C. Rock gabions, or
- D. Concrete check dams with weir openings.

Table 6.6-6: Check Dam Spacing for Design Option 1

Channel Slope (%)				
2	3	4	5	6
Check Dam Spacing (Feet)				
100	67	50	40	33

Design Procedure Option 2:

This method uses a runoff volume for the swale design. The runoff volume (when the design is intended to meet water quality requirement), is determined using the Direct Determination Method (or similar) as discussed in Section 3. The vegetated swale is then designed to hold and infiltrate or filter the design volume. Check dams can be used to provide additional storage volume. In this case, check dam spacing is not based on Table 6.6-6, but should be based on the necessary design volume. Check dams used for this purpose should be constructed of a material that will adequately impound the necessary volume of water, such as timber or concrete.

The vegetated swale should be designed to empty the water quality volume within 48 hours. If native soils have slow percolation rates and/or if the swale slope is flat, a subdrain can be placed under the swale flow line to collect excess water and direct it to a receiving systems. If a subdrain is used, 24 to 36 inches of permeable top soil should be placed above the subdrain, and the subdrain should be surrounded by pea gravel lined with geotextile fabric. The subdrain should be a minimum of 6 inches in diameter. This is very similar to the cross section presented in Section 6.6.1, Figure 6.6-1b.

When a volume based design is used, the longitudinal slope of the swale should permit the temporary ponding of the stormwater runoff within the channel without having excessively deep water at the downstream end. Ponding at the downstream end or at the check dam should not exceed 18 to 24 inches.

Vegetation:

If a vegetated swale is designed based on a flow rate (option 1), vegetation height in the swale shall not be less than the depth of flow at the water quality event.

In all cases, select plants based on their functional abilities to withstand the design flow and velocity; tolerance of exposure to potential contaminants; contaminant removal potential; hardiness in the Anchorage area; aesthetic appeal; and nutrient and maintenance requirements. Consideration of potential contaminants shall include, but not be limited to: suspended solids, excess nutrients, non-soluble heavy metals, oil, grease, de-icing salts, and winter sanding particles. Maximize available light and warmth to encourage vigorous plant growth for the longest time possible. A southern exposure with little shade is preferred. Native plants and compost-amended soil also encourages mycorrhizal fungi; this fungi enhances infiltration, nutrient breakdown, and carbon sequestration. Additional guidance with selecting non-invasive plant species appropriate for vegetated swales is presented in Appendix E. Engineers are encouraged to consult botanists, landscape architects, and/or horticulturists for guidance on plant selection and implementation.

Impermeable Liner Option:

If there is a possibility of groundwater contamination, such as the facility does not meet minimum separation from groundwater, or if the facility is intended to accept hotspot runoff, a 12-inch bentonite clay or other impermeable liner can be placed under the swale.

Inlet:

Install a flow-spreading device to uniformly distribute concentrated flow in the swale inlet or across the width of the filter strip. Shallow weirs, check dams, stilling basins, riprap, and perforated pipes provide for energy dissipation at the inlet. For riprap, six- to nine-inch rocks shall be fitted tightly together across the bed and for a distance of 5 to 10 feet down gradient. Provide access for sediment clean out of inlet structures.

Curb cuts in a parking lot and/or a shallow stone trench installed across the top of a filter strip can serve as a level spreader. If flow is to be introduced via curb cuts, place pavement slightly above the swale elevation. Curb cuts shall be at least 12 inches wide with non-vertical side slopes to prevent clogging and crumbling.

Access:

Access for maintenance is required along all constructed channels. Access to swales is necessary so that the property owner can inspect, monitor, and maintain the facility.

Construction and Sequencing

- A. Avoid soil compaction.
- B. Do not use Vegetated Swales as sediment traps or sediment control facilities during construction.

Maintenance:

Description of required maintenance includes but is not limited to the following:

- A. Annual cleaning of the inlet structures following breakup (or more frequently if necessary).
- B. Routine and post-storm event inspections.
- C. Appropriate watering, pruning, mowing, and vegetation harvesting.
- D. Insect and pest control (if organic methods are not used, Integrated Pest Management Practices are recommended for water quality and stormwater devices).
- E. Fertilizer application (this may not be needed depending on nutrient load of contributing flows).
- F. Reseeding and plant replacement.
- G. Sediment removal.
- H. Trash removal and other necessary tasks.

Table 6.6-7: Summary of Maintenance Activities for Vegetated Swales

Activity	Frequency
Inlet structure cleaning	Once a year (following breakup)
Routine inspections	On a routine basis and following significant rainfall events
Watering, pruning, moving, and vegetation harvesting	As needed
Reseeding and plant replacement	As needed based on visual inspection
Sediment and trash removal	As needed based on visual inspection

6.6.6 Pervious Pavement

<p><u>Description</u></p> <p>A system that reduces impervious surfaces, thus increasing infiltration and reducing runoff. A system may include modular paving blocks or grids, porous asphalt, cast-in-place concrete grids, or soil amendment technologies.</p>																										
<p><u>Stormwater Management Suitability</u></p> <table> <tr> <td><i>Runoff:</i></td> <td></td> <td><i>Suitable to meet or help meet requirements for:</i></td> </tr> <tr> <td>Rate Control:</td> <td>Moderate</td> <td>Water Quality Treatment through Green Infrastructure ✓</td> </tr> <tr> <td>Volume Reduction:</td> <td>High</td> <td>Detention ✓</td> </tr> <tr> <td><i>Implementation Considerations:</i></td> <td></td> <td></td> </tr> <tr> <td>Land Requirement:</td> <td>Low</td> <td></td> </tr> <tr> <td>Capital Cost:</td> <td>Moderate</td> <td></td> </tr> <tr> <td>Accepts Hotspot Runoff:</td> <td>No</td> <td></td> </tr> <tr> <td>Maintenance:</td> <td>Moderate</td> <td></td> </tr> </table>			<i>Runoff:</i>		<i>Suitable to meet or help meet requirements for:</i>	Rate Control:	Moderate	Water Quality Treatment through Green Infrastructure ✓	Volume Reduction:	High	Detention ✓	<i>Implementation Considerations:</i>			Land Requirement:	Low		Capital Cost:	Moderate		Accepts Hotspot Runoff:	No		Maintenance:	Moderate	
<i>Runoff:</i>		<i>Suitable to meet or help meet requirements for:</i>																								
Rate Control:	Moderate	Water Quality Treatment through Green Infrastructure ✓																								
Volume Reduction:	High	Detention ✓																								
<i>Implementation Considerations:</i>																										
Land Requirement:	Low																									
Capital Cost:	Moderate																									
Accepts Hotspot Runoff:	No																									
Maintenance:	Moderate																									
<p><u>Key Considerations</u></p> <p><i>Advantages:</i></p> <ul style="list-style-type: none"> • Reduce or eliminate other stormwater management techniques • Helps soften the look of an area and make it more pleasant for pedestrians • Stabilizes soil without reducing its permeability • Works well even in slowly infiltrating soils <p><i>Limitations:</i></p> <ul style="list-style-type: none"> • Pervious pavements are not recommended for high-traffic areas • Snow removal can be difficult for some types of paving blocks • Can limit wheelchair access (depending on pavement type) <p><i>Design:</i></p> <ul style="list-style-type: none"> • Soil type will affect infiltration rates and must be considered • Structural section must be designed to work with native soils • Appropriate for driveways, walkways, and overflow parking areas 																										

Description:

Pervious pavement includes several techniques that reduce impervious surfaces, thus increasing infiltration and reducing runoff. The options include modular paving blocks or grids, cast-in-place concrete grids, pervious asphalt and concrete, and soil enhancement technologies. All of these methods increase a

site's load-bearing capacity, allowing for foot and vehicle traffic along with healthy grass growth. But they are not always appropriate for year-round use or in heavily trafficked areas.

Common applications include parking areas, roadside right-of-ways, emergency access lanes, and delivery access routes.

Traffic volume, typical vehicle loads and need for snow plowing can limit application. In residential areas, alternative surfaces can be used for driveways and walkways, but, due to their texture, are not ideal for areas that require accessibility for handicapped people.

Modular Paving Blocks and Grids

Modular paving blocks or grass pavers consist of concrete or plastic interlocking units that provide structural stability while a series of gaps planted with turf grass allow for infiltration. Some blocks may also be filled with gravel and left implanted. Depending on the use and soil type, a sand setting bed and gravel subbase is often added underneath to help further infiltration and prevent settling.

Products include rigid rectangular modules that are installed like paving stones and flexible rolled material that is cut to size and snapped together.

Cast-in-Place Concrete Systems

Cast-in-place, monolithic concrete pavement incorporates gaps that are filled with topsoil and grass for a free-draining "pavement" with the structural capacity to handle most heavy vehicle loads. The surface is similar to that of modular concrete paving blocks.

Porous Asphalt

Pervious asphalt is asphalt designed with a specific type of asphalt mix that allows water to percolate through it. The asphalt is typically installed on top of a structural section with sufficient void space to store water and allow it to slowly percolate into the native soil. The structural section is designed for applicable site loading.

Soil Enhancements

The soil-amendment technology discussed here employs synthetic mesh elements blended with a sandy growing medium, resulting in a natural turf surface and an engineered load-bearing root zone. This proprietary technology is appropriate for summer overflow parking, golf courses, recreational fields and areas where the aesthetic appeal of uninterrupted grass is important.

Benefits:

- A. Pervious pavement reduces or eliminates other stormwater management techniques by reducing runoff.
- B. If applied in combination with other low impact development systems, pollutant removal and stormwater management can be further improved.
- C. Construction costs for pervious pavement may be lower or higher than conventional pavements. There may be cost savings due to reduced curb-and-gutter requirements and reduced size of conveyance and treatment systems.
- D. Pervious pavement is appropriate for driveways, walkways, and overflow parking areas.

- E. Soil-enhanced pervious pavement systems are advantageous for sports and recreation fields as they resist compaction, thus increasing infiltration, and provide a soft playing surface.
- F. The mesh elements in engineered soil reportedly stabilize soil without reducing its permeability. The elements are thought to combat compaction, as they flex under pressure and "cultivate" the surrounding soil.
- G. Snow may melt faster on a porous surface because of rapid drainage below the snow surface and black ice conditions can be reduced.

Limitations:

- A. For reasons of durability and maintenance, pervious pavement is not recommended for high-traffic areas.
- B. Turf paving systems limit wheelchair access.
- C. Snow removal can be difficult for modular paving blocks and grids, as plow blades can remove vegetation and catch the edge of the blocks, damaging the surface (see Maintenance section).
- D. Excessive sanding can clog the pervious pavement if the pavement is not adequately maintained.
- E. Construction costs may be higher or lower than conventional pavements. Maintenance costs are generally higher.

Design Considerations:

This section present a general overview and design considerations for various types of pervious pavements. In all cases, the system design should be site-specific and should include the recommendations and design involvement of a geotechnical engineer.

The designer should consider the whole layout and use of the site when selecting location and type of pervious pavements. Consider how traffic and pedestrians will enter, exit, and move around within the site. Consult the site's maintenance entity to gain a clear understanding how the site be maintained.

Modular and Cast-in-Place Concrete Systems-

- A. Soil type will affect infiltration rates and must be considered when designing a turf paver area.
- B. Subbase depth and characteristics should be based on the site and the recommendations of a geotechnical engineer. Typical subbase designs vary from 3 to 10 inches of compacted aggregate/gravel. Some systems recommend a 1.5-inch sand setting bed. Depending on soils, residential applications may not require any added subbase.
- C. Fill voids with sand or sandy loam planting base (follow manufacturer's recommendations).
- D. Plant with "park grade" turf grasses which are more drought tolerant than "elite grade" grasses.
- E. To avoid sediment-clogged cells, avoid routing large runoff volume directly from adjacent impervious areas to turf pavers.
- F. Turf pavers can be attractively combined with dry-set pavers or any number of other pavement types.
- G. Follow manufacturers' recommendations for each system.

Porous Asphalt

- A. The asphalt mix design should be completed by a geotechnical engineer with experience in asphalt design. For parking area, the mix design should consider loading from wheel-turning.
- B. The systems structural section should be designed by a geotechnical engineer with the following considerations:
- C. The structural section should be site-specific and designed to work with the native soil. Poorly designed structural sections can cause asphalt failure.
- D. The storage capacity of the structural section (and the associated void space of the selected material) will vary based on the design rainfall event that porous asphalt is intended to capture as well as the infiltration rates of the native soil. For slower infiltrating soils, more storage may be needed. Native infiltration rates must be based on field testing.
- E. Porous asphalt can be designed with perforated pipes in the top of the section to direct excess water, beyond the storage capacity of the section, to an appropriate receiving system.
- F. Avoid placing mulch or open soil immediately adjacent to porous asphalt. Soil and broken or decomposed mulch can migrate onto the porous asphalt surfaces and can clog the asphalt pores.

Soil Enhancement

- A. Depending on site needs and budget, engineered growing medium may be mixed with mesh elements on site or obtained as solid slabs of mature turf with mesh elements already in the growing medium.
- B. When existing subsoil drainage is poor, slit drains may be necessary. They will consist of perforated or porous pipes in gravel-filled trenches leading to outfall. Spacing of drains, typically three to five feet, will depend on location and intended use.
- C. Root zone medium will be six to eight inches deep.
- D. Aggregate base depth will depend on vehicle loading and subgrade strength, as determined by a geotechnical engineer. Range of aggregate is from approximately 4 to 20 inches (the latter for weak subgrade and use by heavy trucks).

Construction and Sequencing:

- A. In all cases of pervious pavements, it is critical that the native subgrade is not driven on during construction. This will compact the soil, limit the infiltration capacity, and may result in facility failure.
- B. Pervious pavement subgrades shall not be used for material or equipment storage during construction.
- C. Full time, on-site inspection by inspectors who are thorough familiar with all elements of the design is recommended.
- D. If runoff from adjacent surfaces is directed to pervious pavements, adjacent surfaces should be completely stabilized prior to contributing water to the pervious pavement. Failure to stabilize adjacent surfaces can result in pavement failure.

Modular and Cast-in-Place Concrete Systems

- A. *Cells may be planted in one of three ways:*
 - 1. Fill with a porous backfill mix (some products require sharp sand), scrape or backrake the entire surface to expose pattern. Broadcast seed, stolons or hydroseed and then top dress and fertilize as required.
 - 2. Fill and scrape or backrake as above, then lay 5/8-inch sod on the assembled pavers. Water the sod, then use a hand water roller or power-driven roller to compress the sod and root system completely into the cells.
 - 3. Do not fill the cells with any type of soil mixture. Lay one-inch sod on the assembled pavers. Water the sod and compress as above.
- B. Some manufacturers may supply or recommend a polymer growing medium to be used with their paving product.

Porous Asphalt

- A. Construction of porous asphalt should follow the designer's specifications.
- B. The asphalt should be installed using an adequate numbers of skilled workers who are thoroughly trained and completely familiar with the specified requirements for installation.
- C. If porous asphalt is used in conjunction with traditional asphalt, seams should be saw-cut to provide a smooth transitional edge to avoid raveling.
- D. Tack-coat should not be installed on porous asphalt.
- E. A permeability test should be completed after the asphalt is constructed. Application rates shall be as specified by the engineer.

Soil Enhancements-

- A. Sand or a proprietary growing medium is blended with a specific proportion of mesh elements using a mechanical shovel. A 20 kilogram sample of mixed material will contain 54.4 to 66.7 grams of mesh elements (or approximately 44 pound mesh for five cubic yards of sand mix). Manufacturer will supply precise proportions.
- B. For some proprietary systems materials are sourced locally and the patent holder acts as project manager for the installation, using specially designed machines.
- C. Grass cover is established using pre-germinated seed, washed turf or conventional seed.
- D. Nonessential traffic should be kept off the area until grass is well established.

Maintenance:

- A. The entire parking lot should be swept using a street sweeper a minimum of two times per year during non-snow covered months to minimize the anticipated sediment load.
- B. Vacuum sweeping is recommended at least twice annually if the equipment is available, with one sweeping performed in spring after snowmelt due to the heavy sediment load retained in the snow pack. This is especially important for areas that will be directly sanded.
- C. Minimize or avoid the use of sand on porous asphalt during the winter months to minimize potential for clogging, particularly if vacuuming sweeping is not possible. Use of sand on any adjacent regular asphalt should also be minimized.

- D. Care should be taken when plowing pervious pavements. For modular and case-in-place systems and for areas where amended soil techniques have been used , the blade should be kept high to avoid nicking the paving blocks or damaging vegetation. For porous asphalt, it may be beneficial to install skids on the corners or a flexible plastic/rubber piece on the bottom of the blade to eliminate the potential for contact and pavement damage.
- E. Generally turf pavers and soil-amended turf can be mowed, irrigated, and fertilized like any other turf area. Do not aerate.
- F. High-frequency traffic (a vehicle traveling over the same area three times or more daily) on turf areas tends to establish a wear pattern. When allowed a "rest", however, the turf will quickly grow back to its kept height.
- G. Organic debris (i.e., leaves, pine needles, etc.) should be regularly removed to avoid clogging associated with breakdown of organic materials into fine particles.
- H. Minimize or avoid the use of salts to minimize the resulting increased infiltration of meltwater.
- I. Periodic gravel replacement is recommended for systems incorporating a gravel layer between paver products. Gravel replacement frequency should be based on visual inspection.

Table 6.6-8: Summary of Maintenance Activities for Pervious Pavement

Activity	Frequency
Vacuum sweeping of pervious asphalt, pervious concrete, and pavers	Twice a year during non-snow-covered months (Once after breakup)
Removal of organic debris (i.e., leaves, pine needles, etc.)	As needed
Gravel replacement of systems incorporating a gravel layer between paver products	As needed
Mowing, irrigation, and fertilization of turf pavers and soil-amended turf	As needed

Recommended References:

- General Porous Asphalt Bituminous Paving and Groundwater Infiltration Beds, specification by UNH Stormwater Center, February, 2005.
- *Design, Construction, and Maintenance Guide for Porous Asphalt Pavements, Information Series 131*, National Asphalt Pavement Association (NAPA), 2003.
- *Design, Construction, and Maintenance of Open-Graded Friction Courses, Information Series 115*, NAPA, 2002.
- *Annual Book of ASTM Standards*, American Society for Testing and Materials, Philadelphia, PA, latest edition.
- *Standards of the American Association of State Highway and Transportation Officials (AASHTO)*, latest edition.
- *Section 40.06-Asphalt Concrete Pavement, Municipality of Anchorage Standard Specifications*, latest edition.

6.6.7 Chamber Systems

<p>Description</p> <p>Chamber systems are arch-shaped, open bottom structures typically used as a component for providing increased subsurface storage volume for stormwater runoff.</p>																									
<p>Stormwater Management Suitability</p> <table border="0"> <tr> <td colspan="2">Runoff:</td> <td rowspan="2">Suitable to meet or help meet requirements for:</td> </tr> <tr> <td>Rate Control:</td> <td>High</td> </tr> <tr> <td>Volume Reduction:</td> <td>High</td> <td>Water Quality Treatment through Green Infrastructure ✓</td> </tr> <tr> <td colspan="2">Implementation Considerations:</td> <td>Detention ✓</td> </tr> <tr> <td>Land Requirement:</td> <td>Low</td> <td></td> </tr> <tr> <td>Capital Cost:</td> <td>High</td> <td></td> </tr> <tr> <td>Accepts Hotspot Runoff:</td> <td>No¹</td> <td></td> </tr> <tr> <td>Maintenance:</td> <td>Low</td> <td></td> </tr> </table>			Runoff:		Suitable to meet or help meet requirements for:	Rate Control:	High	Volume Reduction:	High	Water Quality Treatment through Green Infrastructure ✓	Implementation Considerations:		Detention ✓	Land Requirement:	Low		Capital Cost:	High		Accepts Hotspot Runoff:	No ¹		Maintenance:	Low	
Runoff:		Suitable to meet or help meet requirements for:																							
Rate Control:	High																								
Volume Reduction:	High	Water Quality Treatment through Green Infrastructure ✓																							
Implementation Considerations:		Detention ✓																							
Land Requirement:	Low																								
Capital Cost:	High																								
Accepts Hotspot Runoff:	No ¹																								
Maintenance:	Low																								
<p>Key Considerations</p> <p>Advantages:</p> <ul style="list-style-type: none"> • Can be very effective in reducing peak runoff flows • Can be used in sites with insufficient space to construct larger facilities • Can be useful in retrofit projects <p>Limitations:</p> <ul style="list-style-type: none"> • Avoiding groundwater contamination must be considered • Must be located in areas where the system can be easily accessed for maintenance <p>Design:</p> <ul style="list-style-type: none"> • Pretreatment is recommended • Select product in accordance with manufacturers specifications • Chamber systems generally consist of foundation layer, embedment stone, plastic chambers, geotextile fabric, and inlet/outlet structures 																									

(1) Yes, if runoff pretreatment is provided

General Description:

Chamber systems are arch-shaped, open bottom structures available in various sizes and related storage capacities. Chambers are typically used as a component for providing increased subsurface storage volume for stormwater runoff. Chamber systems are similar in many ways to infiltration trenches. However infiltration trenches rely on the void ratio of the stone reservoir to hold the runoff while it slowly infiltrates into the subsoil. Chamber system are typically not filled with rock, so they provide a large void

capacity and can be used to increase the storage and allow more infiltration over time. Additionally, they are highly versatile and can be used under open spaces such as parking lots and athletic fields.

Chamber systems are most effective where the subsoil is sufficiently permeable to provide a reasonable infiltration rate and where the water table is low enough to prevent pollution of groundwater. However, where the subsoil is not sufficiently permeable to provide a reasonable infiltration rate, chamber systems can be used as subsurface detention facilities or subdrains can be incorporated. In general, a pretreatment design which prevents trash debris, or excessive sediment from entering the chambers and potentially clogging the outlet device must be provided. A conceptual layout is shown in Figure 6.6-7.

Figure 6.6-7: Chamber System Schematic

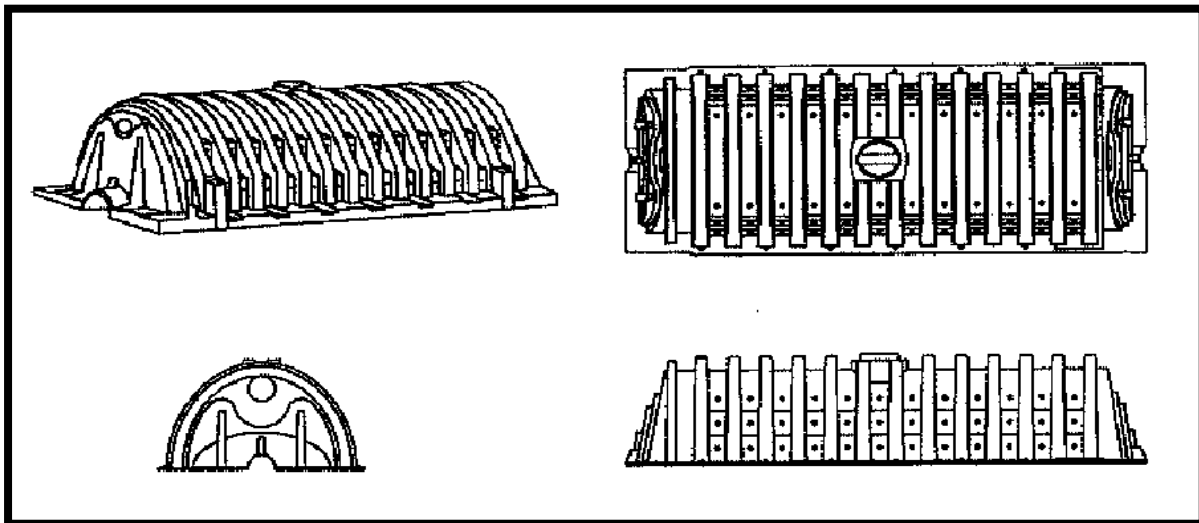

Source: Virginia Stormwater Management Handbook, 1999

Advantages:

- A. Reduced volume of discharge from a site.
- B. Can be very effective for removing fine sediment, trace metals, nutrients, bacteria, and oxygen-demanding substances (organics).
- C. Reduces downstream flooding and protects streambank integrity.
- D. Reduces the size and cost of downstream stormwater control facilities and/or storm drain systems by infiltrating stormwater in upland areas.
- E. Provides groundwater recharge and baseflow in nearby streams.
- F. May eliminate need for above ground systems, thus reducing thermal impacts of the stormwater runoff.
- G. Can be utilized where space is limited and in retrofit applications.

Limitations:

- A. Potential failure due to improper design and lack of maintenance, especially if pretreatment is not incorporated into the design.
- B. Depending on soil conditions, land use in the watershed and groundwater depth, a risk of groundwater contamination may exist.
- C. Not appropriate for industrial or commercial sites where the release of large amounts or high

concentrations of pollutants is possible.

- D. Susceptible to clogging by sediment if adequate pretreatment is not incorporated, resulting in frequent maintenance.
- E. Careful consideration should be given to address the possibility and effect of introducing water into the road structural section. An overflow system may be required (see discussion in this section).

Design:

Site Sensitivity Analysis:

- A. Runoff water quality: If runoff water will contain a significant concentration of soluble pollutants that could contaminate groundwater, a chamber system should not be used. Specifically, chamber systems do not accept hotspot runoff unless the design incorporates appropriate pretreatment.
- B. Degree of detail: The level of detail required for design should be considered. For instance, a small structure receiving runoff from a rooftop will not require as much detail as a structure serving a larger area and having a higher potential pollutant load.
- C. Calculations to determine groundwater mounding (local elevation of the water table as a result of infiltrated surface water) may be necessary in cases where slope stability is a concern, and/or a high water table is encountered. A hydrogeologist should be consulted with respect to the potential for groundwater mounding in these areas. The results from groundwater mounding calculations should be regarded as an indication of the mounding potential rather than as an accurate representation of the actual mounding depth.
- D. See Section 6.2 and Table 6.4-1 for applicable set back requirements, infiltration rates, depth to groundwater, and depth to bedrock.

General Design Considerations:

Manufactured Systems-

Chamber systems installed in Anchorage must be manufactured systems offered by a reputable manufacturer. Individually designed chamber systems are not permitted. Many manufactures offer chamber systems including Stormtech, Contech, Triton, etc. Designers are encouraged to check with local suppliers for availability.

Successful use and long facility life of chambers systems is dependent on various design details that are often system specific. ***Design and installation shall comply with manufacturers recommendations and specifications.***

Pretreatment and Sediment Removal-

Chamber systems are susceptible to high failure rates due to clogging from sediments, and therefore require pretreatment of stormwater in order to remove as much of the suspended solids from the runoff as possible before it enters the trench. In locations where runoff is from roadways, parking lots, or other locations where high sediment loads are expected, pretreatment shall be incorporated as applicable.

Pretreatment may include grit chambers, swales with check dams, filter strips, or sediment forebays/traps, etc. Even when infiltrating rooftop runoff, it is practical to implement some form of pretreatment to remove sediments, leaf litter, and debris. This pretreatment will help to ensure the proper functioning of the infiltrating facility and allow for longer periods between maintenance.

Manufacturers may also provide recommended pretreatment systems for their facilities, or the facilities may have pre-treatment components that are part of the system.

In many configurations of chamber designs, the primary form of pretreatment is an OGS located upstream of the chambers. The effectiveness of an OGS at removing sediment depends on many factors including sediment loading, properties of incoming sediment, flow rate, and OGS type and configuration. Depending on the runoff characteristic, an OGS alone may not be sufficient for sediment removal, and chambers are frequently constructed with little to no maintenance access for sediment removal.

Another option for capturing sediment is to utilize one row of “treatment” chambers to capture the “first flush” of sediment from small, frequent storm events. This is typically achieved by installing a manhole with a diversion weir or by setting pipe elevations to facilitate appropriate water diversion. Water that enters the manhole is directed to the treatment row of chambers until that chamber becomes full and/or the weir is overtopped. Water then enters the remaining chambers normally. This configuration allows the runoff carrying the most sediment to be treated in the treatment row instead of distributing sediment through the system. Sediment build-up can then be removed with a vacuum truck through the manhole. The figure below is taken from the Stormtech® design manual, and illustrates this concept. The Stormtech treatment row is called an Isolator Row, and Stormtech chamber systems are commonly configured this way. Additional information is available in the manufacturer’s product literature.

If the “Isolator Row” concept is used for chamber systems for public projects, the isolator row(s) must be limited to 150 feet long to accommodate MOA maintenance equipment.

Chamber Configuration-

Chambers should be configured and spaced in accordance with the manufacturer’s recommendations. The designer should note the specified distance between chambers, as well as the thickness and width of backfill material around the chambers. In all cases, vertical stacking of chambers is prohibited.

Depth of Cover

The depth of cover over chamber systems should ensure adequate protection from freezing and comply with manufacturer’s recommendations based on the chamber system location and anticipated surface loading. The minimum allowable depth of cover shall be either the appropriate manufacturer’s recommended depth based on loading, or the depth described in Section 5.3.3, whichever is less.

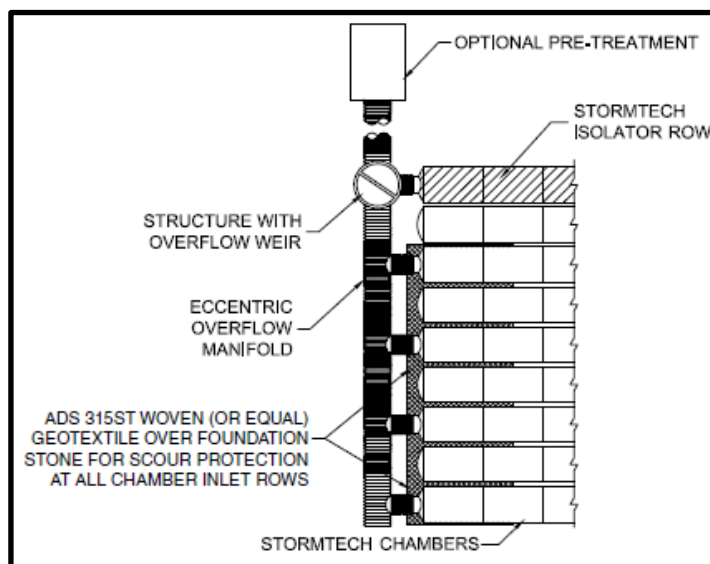
Figure 6.6-8: Stormtech Isolator Row Concept

Source: Stormtech® Chamber Systems Design Manual, 2012

Subsurface Soil-

If the system is placed in an area receiving live loading, such as traffic loading, the sub-grade soil conditions should be assessed with consideration of soil moisture contents expected under a stormwater system.

Overflow structure-

An overflow or bypass structure should be provided to convey flow from storms larger than the event the facility is designed to accommodate.

The overland flow path of surface runoff exceeding the capacity of the chamber system should be evaluated to preclude erosive concentrated flow. If computed flow velocities do not exceed the non-erosive threshold, overflow may be accommodated by natural topography. All overflow designs must be in accordance with the downstream capacity requirements discussed in Section 3.

Access Ports-

Access ports are required to allow for monitoring of water and sediment levels in the chamber system. Locate access ports in each row of chamber system.

System Design-

Chamber systems can be designed in many configurations to meet the specific limitations of the site and the main purpose for which they are being used. The designer must verify that the use of the selected product is in accordance with the manufacturers specifications. General design considerations may include the following:

- 1) Pretreatment,
- 2) Native soil conditions

- 3) Backfill requirements,
- 4) Geotextile fabric,
- 5) Observation well,
- 6) Foundation requirements,
- 7) Chamber spacing,
- 8) Row separation,
- 9) Inlet and outlet design, and
- 10) Maintenance considerations.

Retention Time-

The appropriate retention time for a chamber system depends on the function of the facility. If the facility is being used solely to meet water quality requirements (0.52 inches of rain in 24 hours), then the maximum allowable storage duration is 48 hours. A storage duration of up to 72 hours is allowed for runoff from rainfall depths greater than 0.52 inches, as long as it is demonstrated that sufficient volume is recovered within 48 hours for runoff from the water quality event.

Construction and Sequencing:

- A. A chamber system should not be placed into service until all of the contributing drainage area has been stabilized. Runoff from untreated, recently constructed areas within the drainage area may load the newly formed chamber system and/or pretreatment facility with large volume of fine sediment. Other devices, such as temporary inlet structures, can be used until site stabilizations is achieved.
- B. Proper installation is critical for the longevity of chamber systems. Designers and contractors are encouraged to require a pre-construction conference with a manufacturer's representative to discuss proper installation.
- C. If the facility incorporates an Isolator Row for treatment, the geotextile fabric lining the Isolator Row shall be one continuous piece. Seams are not permitted. Maintenance equipment may catch a seam during facility cleaning, causing the fabric to tear, bind, or unravel and eliminating the usefulness of the Isolator Row.

Maintenance:

Maintenance is required for the proper operation of chamber systems. Maintenance should comply with manufacturers recommendations and the criteria below.

- A. The use of pretreatment systems will significantly minimize maintenance requirements.
- B. Once the system has gone online, inspections should occur after each significant rainfall event for the first few months to ensure proper stabilization and function. Water levels in the access ports should be recorded over several days to check chamber drainage.
- C. After the first few months of operation, the system should be inspected at least twice per year. Important items to check for include: accumulated sediment, leaves and debris in the pretreatment device, clogging of inlet and outlet pipes and ponded water both inside and

outside of the system.

- D. Pretreatment devices associated with chamber systems should be inspected and cleaned at least twice a year.
- E. If the design incorporates an Isolation or “treatment” row, sediment levels in the treatment row should be checked at least twice per year. Sediment should be removed when it reaches depths specified by the manufacturer (commonly three inches) or when facility performance (due to slow percolation through the accumulated sediment) is reduced beyond acceptability.

Table 6.6-9: Summary of Maintenance Activities for Chamber Systems

Activity	Frequency*
Inspect and clean pretreatment devices	Twice a year
Routine inspections (for the first few months on-line)	After every significant rainfall
Record water levels in observation well (for the first few months online)	After every significant rainfall
Routine inspections (after the first few months online)	Twice a year
Check sediment levels in isolation rows and remove sediment if needed	As needed or at least twice a year

**Alternate maintenance schedules may be submitted for approval for projects within municipal ROW. Coordinate with Street Maintenance and PM&E.*

Rehabilitation:

- A. Pretreatment and regular maintenance will significantly extend the life of a chamber system. Eventually, chamber systems should be rehabilitated, but this time span is relative to the effective performance of the system. With appropriate design and aggressive preventive maintenance, this rehabilitation may not be necessary for a decade or more.
- B. Pondered water inside the system (as visible from the access ports) after the design retention time (up to 72 hours following a storm event) often indicates that the bottom of the chamber is clogged, indicating a percolation failure from the bottom. In this case, all of the stone aggregate and geotextile fabric or media must be removed. Accumulated sediment should be stripped from the bottom. At this point the bottom may be scarified or tilled to help induce infiltration. New fabric and clean stone aggregate should be refilled.

6.6.8 Wet Ponds

<p>Description</p> <p>A constructed stormwater pond that retains a permanent pool of water.</p>																										
<p>Stormwater Management Suitability</p> <table> <tr> <td>Runoff:</td> <td></td> <td>Suitable to meet or help meet requirements for:</td> </tr> <tr> <td>Rate Control:</td> <td>High</td> <td>Water Quality Treatment through Green Infrastructure ✓</td> </tr> <tr> <td>Volume Reduction:</td> <td>Low</td> <td>Detention ✓</td> </tr> <tr> <td colspan="3">Implementation Considerations:</td> </tr> <tr> <td>Land Requirement:</td> <td>High</td> <td></td> </tr> <tr> <td>Capital Cost:</td> <td>Low</td> <td></td> </tr> <tr> <td>Accepts Hotspot Runoff:</td> <td>No¹</td> <td></td> </tr> <tr> <td>Maintenance:</td> <td>Low - Moderate</td> <td></td> </tr> </table>			Runoff:		Suitable to meet or help meet requirements for:	Rate Control:	High	Water Quality Treatment through Green Infrastructure ✓	Volume Reduction:	Low	Detention ✓	Implementation Considerations:			Land Requirement:	High		Capital Cost:	Low		Accepts Hotspot Runoff:	No ¹		Maintenance:	Low - Moderate	
Runoff:		Suitable to meet or help meet requirements for:																								
Rate Control:	High	Water Quality Treatment through Green Infrastructure ✓																								
Volume Reduction:	Low	Detention ✓																								
Implementation Considerations:																										
Land Requirement:	High																									
Capital Cost:	Low																									
Accepts Hotspot Runoff:	No ¹																									
Maintenance:	Low - Moderate																									
<p>Key Considerations</p> <p>Advantages:</p> <ul style="list-style-type: none"> • Capable of removing both solid and soluble pollutants • Potential for wildlife habitat to be created • Pond Sediment removal schedule is generally less frequent than other facilities <p>Limitations:</p> <ul style="list-style-type: none"> • Discharges from ponds usually consist of warmer water • Cannot be placed on steep unstable slopes • Concern for mosquitoes and maintaining oxygen in ponds <p>Design:</p> <ul style="list-style-type: none"> • Large contributing watersheds are required to maintain pool elevations • Avoidance of short-circuiting and the promotion of plug flow • Ponds generally include sediment storage, pond inlet/outlet structures, scour control and access for maintenance. 																										

(1) Yes, if chemical pre-treatment is provided.

General Description:

A Wet Pond, also known as a wet pool, is a constructed stormwater pond that retains a permanent pool of water. Wet Ponds are generally on-line, end-of-pipe systems or centralized systems. The primary pollutant removal mechanism in a Wet Pond is sedimentation. Significant loads of suspended pollutants, such as metals, nutrients, sediments, and organics, can be removed by sedimentation. Dissolved contaminants are removed by a combination of processes: physical adsorption to bottom sediments and suspended fine sediments, natural chemical flocculation, bacterial decomposition, and uptake by aquatic plants and algae. Wet Ponds have a moderate to high capacity for removing most urban pollutants,

depending on how large the volume of the permanent pool is in relation to the runoff from the surrounding watershed. Figure 6.6-9 shows a schematic of a typical Wet Pond.

Generally, large contributing watersheds are required to maintain pool elevations. Minimum contributing watersheds should be at least 10 acres, but not more than one square mile. Sites with less than 10 acres of contributing watershed may be suitable if the design can accommodate a permanent pool or if sufficient groundwater flow is available.

Wet Ponds can be used at residential, commercial and industrial sites. Since Wet Ponds have the capability of removing soluble pollutants, they are suitable for sites where nutrient loadings are expected to be high.

Wet Ponds may be single-purpose facilities, providing only runoff treatment, or they may be incorporated into a detention pond design to also provide peak flow control. Wet Ponds themselves are generally ineffective in decreasing runoff volumes, although some evaporation and infiltration can occur. Evaporation depends on temperature and air moisture content, and infiltration varies with groundwater depth and soil type.

Wet Ponds can accept hotspot runoff. For these cases, the depth to the seasonally high groundwater table should be a minimum of 4-feet from the facility floor, or pre-treatment should be provided.

Wet Ponds work best when the water already in the pond is moved out by incoming flows, through a process called "plug flow." Because treatment works on this displacement principle, the permanent pool of Wet Ponds may be provided below the groundwater level without interfering unduly with treatment effectiveness.

Removal efficiency is primarily dependent on the length of time that runoff remains in the pond, which is known as the ponds Hydraulic Residence Time (HRT). As discussed above, Wet Ponds can remove pollutants not only through sedimentation but also through biological uptake processes, whose removal of pollutants is proportional to the length of time runoff remains in the pond.

Advantages:

- A. Capable of removing both solid and soluble pollutants.
- B. Depending on design, Wet Ponds can be aesthetically pleasing.
- C. Wildlife habitat is created when ponds are properly planted and maintained.
- D. Can increase adjacent property values when planned, sited, and designed properly.
- E. Pond sediment removal schedule is generally less frequent than for other systems.

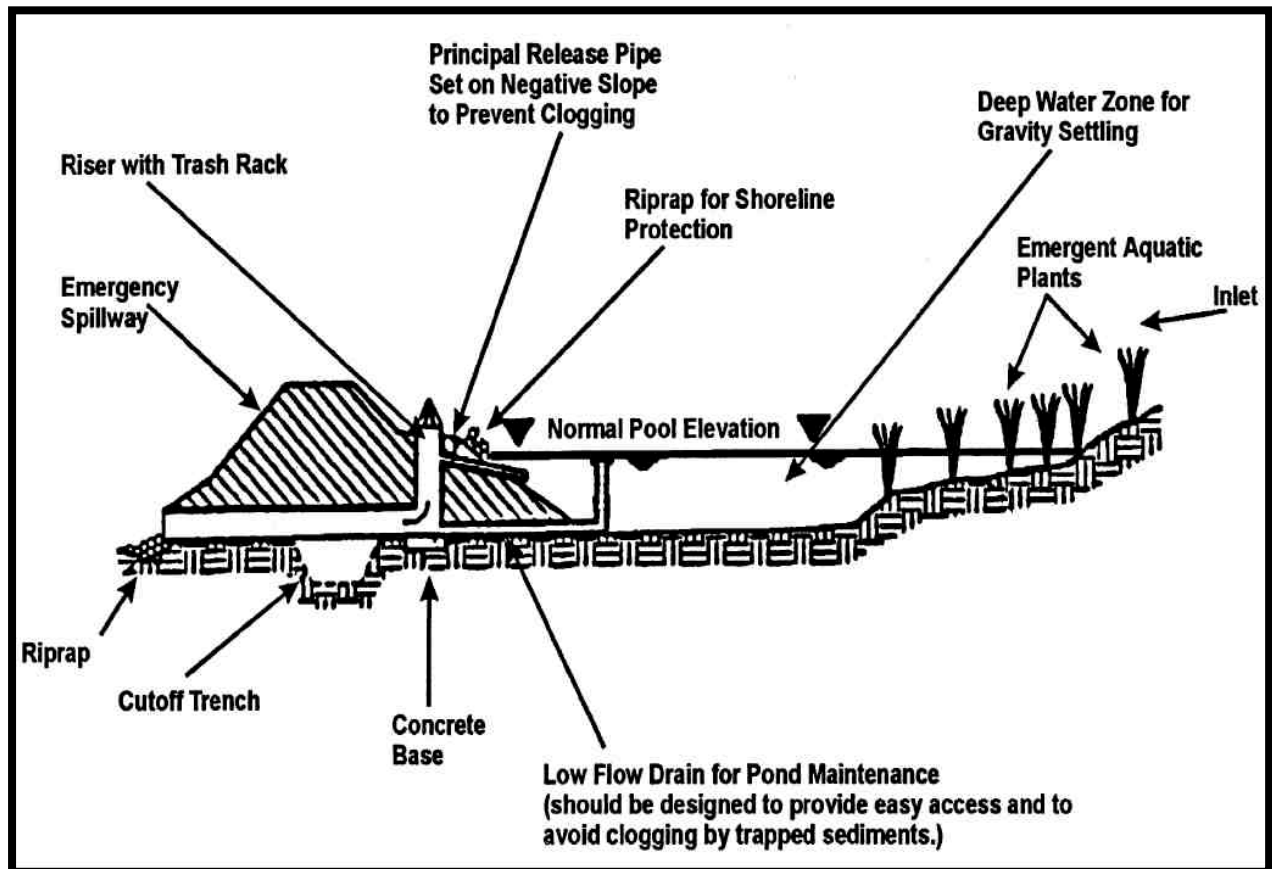
Figure 6.6-9: Typical Wet Pond Design

Source: Minnesota Urban Small Sites Manual, 2001

Limitations:

- A. Generally not prescribed for drainage areas smaller than 10 acres.
- B. Requires relatively large land area.
- C. Improperly designed or maintained ponds may result in stratification and anoxic conditions that can promote the release of nutrients and metals from the trapped sediments.
- D. Discharges from ponds usually consist of warm water, and thus pond use may be limited in areas where warm water discharges from the pond will adversely impact a cold water fishery.
- E. The local climate during winter may affect the biological removal of pollutants in the pond (e.g., lower temperatures decrease the rate of biological activity). Also, formation of an ice layer may reduce the pond's treatment efficiency.
- F. Concern for mosquitoes and maintaining oxygen in ponds.
- G. Cannot be placed on steep unstable slopes.
- H. Depending on volume and depth, pond designs may require approval from dam safety authorities.

Design:*General:*

Dry ponds are subject to the safety criterion presented in Section 6.5. **It should be noted that ponds and embankments large enough to be subject to the state dam safety regulations are prohibited.** The dam regulations can be found online through the Department of Natural Resources website. <http://dnr.alaska.gov/mlw/water/dams/>

Pond Volume and Surface Area:

Wet Pond design volume is dependent on the facility's intended function. If the facility is designed only to meet the water quality requirements, the design volume would be equivalent to the runoff volume generated from the first 0.52 inches of rainfall. However, Wet Ponds can also be designed for larger rainfall events and can help meet detention requirements.

A minimum pool surface area of 0.25 acres is recommended based on the typical drainage area size required to sustain a permanent pool during summer months.

Storage Depth:

Pool depth is an important design factor, especially for sediment deposition. An average pool depth of three to six feet is recommended. Settling column studies and modeling analyses have shown that shallow ponds have higher solids removal than deeper ones. However, re-suspension of settled materials by wind may be a problem in shallow ponds that are less than two feet in depth. The maximum of depth of the pond shall be in accordance with the safety requirements in Section 6.5.

Varying depths throughout the pond are recommended. Intermittent benches around the perimeter of the pond are recommended to enhance public safety and to promote the growth of aquatic vegetation. Six to 18 inches of water are needed for optimum wetland vegetation growth. Deeper depths near the riser will yield cooler water bottom discharges, which may mitigate downstream thermal effects.

Avoidance of short-circuiting and the promotion of plug flow:

To prevent short-circuiting, water is forced to flow, to the extent practical, to all potentially available flow routes, avoiding "dead zones" and maximizing the time water stays in the pond during the active part of a storm. Design features that encourage plug flow and help to avoid dead zones include the following:

- A. Provide a broad surface for water exchange across cells rather than a constricted area.
- B. Maximizing the flow path between inlet and outlet, including the vertical path, enhances treatment by increasing residence time. Baffles or islands can be added within the permanent pool to increase the flow path.
- C. The ratio of flow path length to width from the inlet to the outlet should be at least 3:1. The flow path length is defined as the distance from the inlet to the outlet, as measured at mid-depth. The width at mid-depth can be found as follows:

$$\text{width} = (\text{average top width} + \text{average bottom width})/2.$$

- D. All inlets should enter the first cell. If there are multiple inlets, the length-to-width ratio should be based on the average flow path length for all inlets.

- E. Use a teardrop shape (as opposed to a rectangular one), to help minimize dead zones caused by corners.

Pond Slopes:

The side slopes of the facility shall comply with the safety requirements in Section 6.5 of this manual.

Sediment Management:

A sediment forebay or similar pretreatment device is highly recommended to enhance pollutant removal and to prolong pond effectiveness in larger (>4,000 cubic feet) facilities.

The original design volume of the Wet Pond should take into account gradual sediment accumulation.

An emergency drain (with a pipe sized to drain the pond in less than 24 hours) should be installed in all ponds to allow access for riser repairs and sediment removal.

Sediment Storage Design:

Wet Ponds can be built with capacity for about 25 years of sediment storage. A detailed analysis of pond sediment storage volume may be helpful to determine cost-effective sediment control plans. Methods such as the NRCS equations address many of the sediment storage factors, but they should be evaluated by professionals on a site-specific basis.

Pond Inlet/Outlet Structures and Pipes:

The outlet area should be a deeper micropool to provide final settling and prevent re-suspension of sediments. The outlet device should be carefully designed, since it is important to the operation of the entire pond system.

Inflow points should be designed with energy dissipaters to reduce inflow velocity.

In most cases, emergency spillways or overflows should be included in the pond design. Emergency spillways should be sized to safely pass flows that exceed the design storm flows. The spillway prevents pond water levels from overtopping the embankment, which could cause structural damage to the embankment. The emergency spillway should be located so that downstream buildings and structures will not be negatively impacted by spillway discharges. The pond design should include an emergency drain to assist in pond maintenance. The drain pipe should be designed for gravity discharge and should be equipped with an adjustable gate valve.

The design of the Wet Pond embankment is another key factor to be considered. Proper design and construction of the embankments will prolong the integrity of the pond structure. Seepage through the embankment can also affect the stability of the structure. Seepage can generally be minimized by adding drains, anti-seepage collars, and core trenches. The embankment side slopes can be protected from erosion by using minimum side slopes of 3:1 and by covering the embankment with vegetation or riprap. The embankment should also have a minimum top width of ten feet if the embankment is used to provide drivable access for maintenance.

Scour Control:

Scour is the erosion of pond bottom or bank material due to high flow velocities. Scour control is important

to maintain the function of the pond and reduce erosion, especially near the inlet. Inlet areas and inlet structures should be designed to control velocities at the inlet whether from large or small storm events.

Flow-diffusion devices, including plunge pools, directional berms or other specially created dissipation structures, are often recommended.

Enhancement Options:

There are several common modifications that can be made to a Wet Pond to increase its pollutant removal effectiveness. These options might be desired if the pond is designed to provide water quality treatment during winter months and during spring snow melt, or if heavy pollutant loading is expected. These modifications are described below.

Varied Depths Throughout the Permanent Pool:

Intermittent benches around the perimeter of the pond are recommended for safety and to promote vegetation. The safety bench should be designed to be at least 10 feet wide and located above normal pool elevations. The aquatic bench should be a minimum of 10 feet wide and depths of six to 18 inches should be maintained at normal elevations to support aquatic vegetation. Deeper depths near the outlet will yield cooler bottom water discharges that may mitigate downstream thermal effects during the summer. Figure 6.6-10 shows a Wet Pond with both safety and aquatic benches.

Sediment Forebays:

The settling area for incoming sediments can be increased through the addition of a sediment forebay. The forebay is an excavated settling basin or a section separated by a low weir at the head of the primary impoundment. Forebays serve to trap sediments before the runoff enters the primary pool, effectively enhancing removal rates and minimizing long term operation and maintenance problems. Periodic sediment removal from the forebay is easier and less costly than removal from the primary Wet Pond pool. Sediment forebays should be designed for ease of maintenance. Hard bottom forebays make sediment removal easier, and forebays should be accessible by heavy machinery, if necessary. About 10 to 25 percent of the surface area of the Wet Pond should be devoted to the forebay. The forebay can be distinguished from the remainder of the pond by one of several means: a lateral sill with rooted wetland vegetation, two ponds in series, differential pool depth, rock-filled gabions or retaining wall, or a horizontal rock wall filter placed laterally across the pond. Energy dissipation techniques should be used at the inlet to the sediment forebay to avoid erosion, to promote settling, and to minimize short-circuiting of flows. The length to width ratio of the forebay should be at least 2:1 to minimize short-circuiting.

Pond Shape:

Performance of the Wet Pond may be enhanced by enlarging the surface area to increase volume, as opposed to deepening the pool.

Multi-Stage Outlets:

Wet Ponds may be designed with a multi-stage outlet structure to control discharges from different size storms (e.g., 2- and/or 10-year storms).

Figure 6.6-10: Schematic of a Wet Pond

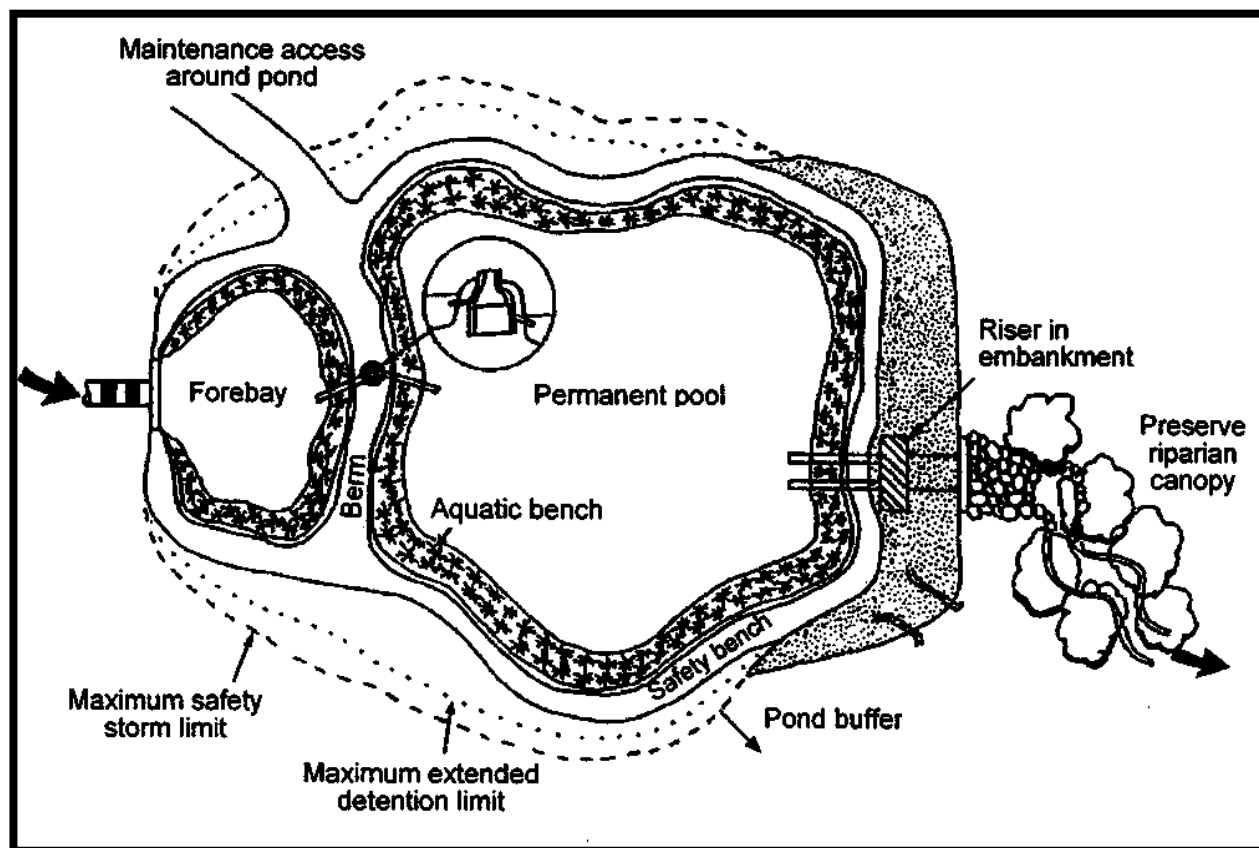

Source: Minnesota Urban Small Sites Manual, 2001

Aesthetic Enhancements:

Many design features can be incorporated to enhance aesthetics where possible, such as:

1. Providing pedestrian access to shallow pool areas enhanced with emergent wetland vegetation. This allows the pond to be more accessible without incurring safety risks.
2. Providing side slopes that are sufficiently gentle to avoid the need for fencing (see Section 6.5 for more information).
3. Creating flat areas overlooking or adjoining the pond for seating that can be used by residents.
4. Including islands within the ponds will create bird habitat, will increase visual appeal, and will make the pond appear to be larger to pedestrians.
5. Incorporating walking or jogging trails into the pond design.
6. Including fountains or integrated waterfall features for privately maintained facilities.
7. Providing visual enhancement with clusters of trees and shrubs.

Establishing Aquatic Vegetation:

Vegetative buffers around the perimeter of the Wet Pond are recommended for erosion control and additional sediment and nutrient removal. Establishing wetland vegetation on the aquatic bench will enhance removal of soluble nutrients, enhance sediment trapping, prevent sediment re-suspension,

provide wildlife and waterfowl habitat and conceal trash and debris that may accumulate near the outlet. Shallow depths near the inlet will concentrate sediment deposition in a smaller, more accessible area.

Construction and Sequencing:

- A. Wet Ponds may be constructed in the early phases of a development project, in order to treat site runoff during construction.
- B. If the basin is used as a sediment trap during construction, all sediment deposited during construction shall be removed before normal operation begins.
- C. The pond's contributing area should be stabilized as soon as possible to minimize sediment inflow and prolong the life and function of the pond.

An access for maintenance, minimum width of 10 feet and a maximum slope of 15 percent must be provided by public or private ROW. This access should never cross the emergency spillway, unless the spillway has been designed for that purpose.

Maintenance Access:

- A. Maintenance access is required to all portions of a pond that will require maintenance. This includes but is not limited to inlets and outlet, and in most cases, the pond floor for vegetation maintenance. The designer is required to consider maintenance activities and provide access for appropriate maintenance equipment in the design. This should involve consulting the appropriate maintenance entity to discuss equipment and access needs.
- B. The maintenance access features of the pond will depend largely on the pond configuration, site configuration, and type of equipment needed. Common maintenance access features include a drivable roadway to the inlet and outlet structures and drivable access to the facility floor. The maximum allowable slope for drivable access is 15 percent. The minimum width is 10 feet.

Maintenance:

- A. Maintenance is required for the proper operation of Wet Ponds. Plans for Wet Ponds should identify owners, parties responsible for maintenance, and an inspection and maintenance schedule for Wet Ponds.
- B. Once constructed, the Wet Pond should be inspected after several storm events to confirm drainage system functions, bank stability, and vegetation growth. Problems should be addressed immediately.
- C. Accumulated trash and debris should be removed from the side slopes, embankment, emergency spillway and weir trash gates as often as needed (at least twice during the growing season). Accumulated sediment in the forebay should be inspected at the same time.
- D. Wet Ponds should be inspected at least twice per year during the growing season to ensure that they are operating as designed. Potential problems that should be checked include: subsidence, erosion, cracking or tree growth on the embankment; damage to the emergency spillway; sediment accumulation around the outlet; and erosion within the basin and banks. Any necessary repairs should be made immediately. During inspections, changes to the Wet Pond or the contributing watershed should be noted, as these may affect basin performance.
- E. Sediment should be removed from the pond as necessary. The frequency of sediment removal

depends on the years of sediment accumulation that were incorporated into the design volume of the Wet Pond's permanent pool and forebay and on the occurrence of any high-loading events. After the initial sediment removal (typically required within five to seven years), future sediment removal is generally less frequent as the contributing area should be stabilized and contributing less sediment load.

- F. In most cases, no specific limitations have been placed on disposal of sediments removed from wet detention ponds. Studies to date indicate that pond sediments are likely to meet toxicity limits and can be safely disposed of in landfills. On-site sediment disposal is always preferable (if locally allowed). Sediments should be deposited away from the shoreline to prevent reentry to the pond and away from recreation areas, to avoid potential ingestion by young children.
- G. Sediments should be tested for toxicants in compliance with current disposal requirements if land uses in the catchment include commercial or industrial zones, or if visual or olfactory indications of pollution are noticed.
- H. Mosquito control should be provided, if necessary.

Table 6.6-10: Summary of Maintenance Activities for Wet Ponds

Activity	Frequency*
Routine inspections (for the first few months on-line)	After every significant rainfall
Routine inspections (after the first few months)	Twice a year (during growing season)
Sediment removal	As needed
Trash and debris removal	Twice a year (during growing season)
Mosquito and pest removal	As needed

**Alternate maintenance schedules may be submitted for approval for projects within municipal ROW. Coordinate with Street Maintenance and PM&E.*

6.6.9 Dry Ponds

<p><u>Description</u></p> <p>A stormwater basin that is designed to intercept a volume of stormwater runoff and temporarily impound the water for gradual controlled release to the receiving stream or storm drain system.</p>																									
<p><u>Stormwater Management Suitability</u></p> <table> <tr> <td colspan="2">Runoff:</td> <td rowspan="2">Suitable to meet or help meet requirements for:</td> </tr> <tr> <td>Rate Control:</td> <td>High</td> </tr> <tr> <td>Volume Reduction:</td> <td>Low¹</td> <td>Detention ✓</td> </tr> <tr> <td colspan="2">Implementation Considerations:</td> <td>Water Quality Treatment through Green Infrastructure³ ✓</td> </tr> <tr> <td>Land Requirement:</td> <td>High</td> <td></td> </tr> <tr> <td>Capital Cost:</td> <td>Low</td> <td></td> </tr> <tr> <td>Accepts Hotspot Runoff:</td> <td>No²</td> <td></td> </tr> <tr> <td>Maintenance:</td> <td>Moderate</td> <td></td> </tr> </table>			Runoff:		Suitable to meet or help meet requirements for:	Rate Control:	High	Volume Reduction:	Low ¹	Detention ✓	Implementation Considerations:		Water Quality Treatment through Green Infrastructure ³ ✓	Land Requirement:	High		Capital Cost:	Low		Accepts Hotspot Runoff:	No ²		Maintenance:	Moderate	
Runoff:		Suitable to meet or help meet requirements for:																							
Rate Control:	High																								
Volume Reduction:	Low ¹	Detention ✓																							
Implementation Considerations:		Water Quality Treatment through Green Infrastructure ³ ✓																							
Land Requirement:	High																								
Capital Cost:	Low																								
Accepts Hotspot Runoff:	No ²																								
Maintenance:	Moderate																								
<p><u>Key Considerations</u></p> <p>Advantages:</p> <ul style="list-style-type: none"> • Can perform well in cold climates • Can limit downstream scour and loss of aquatic habitat <p>Limitations:</p> <ul style="list-style-type: none"> • Changes in flow duration from dry ponds as well as timing of discharge may cause stream erosion and downstream impacts to peak flows • May not be appropriate for removal of smaller sediments. • Potential for clogging of outlets • Sediments can be re-suspended in the pond if not removed between storm events • Erosion of side slopes and basin bottom in improperly designed and constructed dry ponds may exacerbate water quality issues <p>Design:</p> <ul style="list-style-type: none"> • Best suited for draining large areas • Ponds generally include a sediment forebay, micropool, low flow channel, scour control, and/or pond inlet/outlet structures and pipes. 																									

(1) May provide some volume reduction depending on permeability of native soil.

(2) Yes, if pre-treatment is provided.

(3) Provides water quality treatment only if designed with enhancement options for this purpose.

General Description:

Dry ponds are stormwater basins that are designed to intercept a volume of stormwater runoff and temporarily impound the water for gradual release to the receiving stream or storm drain system. Dry ponds are typically on-line, end-of-pipe (centralized) systems. Dry ponds are designed to completely empty out between runoff events, and therefore provide mainly runoff rate control as opposed to water quality control. Dry ponds can provide limited settling of particulate matter, but a large portion of this material can be re-suspended by subsequent runoff events. Therefore, dry ponds should be considered mainly as practices used to reduce the peak discharge of stormwater to receiving streams to limit downstream flooding and to provide some degree of channel protection.

Most dry ponds are designed to empty in a time period of less than 48 hours, resulting in lower contaminant removal (the inter-event settling time does not exist) than retention basins. If water quality treatment is the intended goal of the pond, a retention basin design should be considered.

Dry ponds can limit downstream scour and loss of aquatic habitat by reducing the peak flow rate and energy of stormwater discharges to the receiving stream. Typically, dry ponds are designed so that release rates are comparable to pre-development flow rates.

A diagram of a typical dry pond is shown in Figure 6.6-11.

Figure 6.6-11: Typical Dry pond

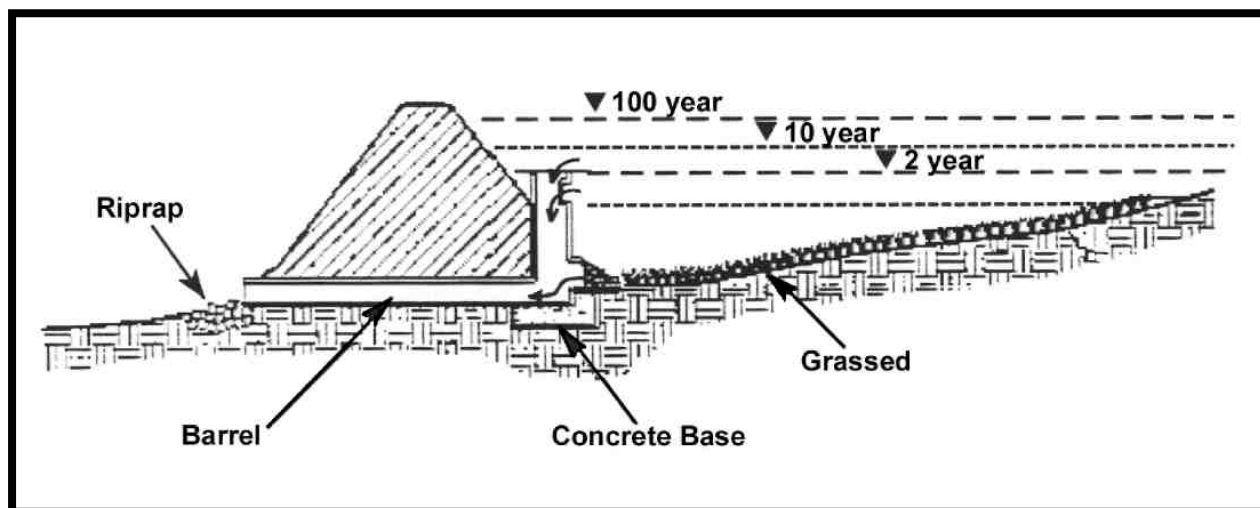

Source: *Minnesota Urban Small Sites Manual, 2001*

Advantages:

- A. Can perform well in cold climates.
- B. Can limit downstream scour and loss of aquatic habitat by reducing the peak flow rate and energy of stormwater discharges to receiving streams.
- C. Can be used as recreational areas (ex. athletic fields) if not needed for water too often and if designed properly.

Limitations:

- A. May not be appropriate for removal of smaller sediments

- B. Potential for clogging of outlets.
- C. Can be considered unattractive by residents.
- D. Poorly maintained basins can create nuisance odors and weed growth and collect trash.
- E. Depending on their volume and depth, pond designs may require approval from dam safety authorities.
- F. Erosion of side slopes and basin bottom in improperly designed and constructed dry ponds may exacerbate water quality issues.
- G. Changes in flow duration from dry ponds as well as timing of discharge may cause stream erosion and downstream impacts to peak flows.

Design:*General:*

Dry ponds are subject to the safety criteria presented in Section 6.5. **It should be noted that ponds and embankments large enough to be subject to the state dam safety regulations are prohibited.** The dam regulations can be found online through the Department of Natural Resources website. <http://dnr.alaska.gov/mlw/water/dams/>

Appropriate Surfaces:

Dry ponds can utilize a variety of surface types, depending on the purpose of the pond. If the pond is intended to provide a water quality benefit, the pond must be vegetated. Vegetation guidelines are provided in Appendix E. If the pond is not intended to provide water quality benefit, it can be incorporated into other parts of the site design such as paved or non-paved overflow parking. Pertinent design criteria (side slopes, etc) must be met for all uses if the pond is placed in a multiple-use area.

Drainage Area:

As a general rule, dry ponds should be implemented for drainage areas greater than 10 acres. This area requirement is a function of the outlet sizing to ensure that the outlet does not become clogged. Smaller drainage areas may be considered as long as careful consideration is given to outlet sizing, detention times, and regular maintenance to prevent clogging.

Detention Time:

Detention time is dependent on the pond's design and intended function. When used for peak flow control, detention time is driven by the allowable outlet hydrograph. The maximum allowable detention time is 48 hours.

Pond Slopes:

The grading in a dry pond is less critical than a wet pond since there is no permanent pool. However, water will be present in these facilities for the design detention time. Therefore, the grading of the pond side slopes should be terraced with an average slope of 3:1 or flatter unless pond safety issues are addressed. (See Section 6.5 for pond safety considerations.) Flatter slopes help to prevent erosion of the banks during larger storms and make routine basin tasks, such as mowing, easier. Flat slopes also provide for public safety, and allow easier access. Steeper slopes may result in fencing requirements, creating unsightly conditions.

Pond Shape:

All stormwater inflow should be conveyed to one inlet location at the pond if possible. Sheet flow into the dry pond is only allowed if proper slope stabilization to minimize erosion and water quality issues is addressed. Sheet flow into a dry pond is not permitted if the dry pond is being used for water quality purposes.

In many cases, the shape of a dry pond is flexible and can be tailored to the needs of a specific site. However, if the dry pond is being used for water quality purposes, the facility must meet the length to width requirements discussed in the “Enhancement Options” portion of this section.

Storage Depth:

The maximum depth and freeboard of the pond shall be in accordance with the safety considerations presented in Section 6.5.

Pond Inlet/Outlet Structures and Pipes:

The pond should be designed in such a way that turbulence in the main treatment area is minimized. For example, inflow points should be designed with energy dissipaters to reduce inflow velocity. Reducing the turbulence will reduce re-suspension of previously deposited material, provide conditions more conducive to settling while the pond is filling, and help prevent pond scour. Energy dissipation at inflow points can also be accomplished with plunge pools, directional berms, micropools, or flow spreaders. See Section 6.6 for additional energy dissipation discussion.

The outlet area should be a deeper micropool to provide final settling and prevent re-suspension of sediments. The outlet device should be carefully designed, since it is important to the operation of the entire pond system. There are numerous outlet configurations possible for dry ponds, such as perforated risers and reversed-slope pipes. The outlet should be located in the pond embankment wherever possible for ease of maintenance and aesthetics. All pond outlet devices shall be designed with protection from clogging.

If an orifice is used in the design of the pond outlet, the minimum allowable orifice diameter is 2-inches, unless approval is granted by the relevant maintenance entity. If maintenance approval is granted, the minimum orifice size is 1-inch. All orifice outlets require protection to protect the orifice from clogging due to debris. Even small pieces of debris can clog a 1 or 2-inch orifice, and care should be taken to minimize this risk. If screens are used as a means to prevent clogging, the screen is required to be upstream of the orifice and have sufficient surface area that common amounts of leaves and debris cannot immediately clog the screen. Small screens placed over the orifice opening are not acceptable.

In most cases, emergency spillways or other bypass/overflow devices should be included in the pond design. Emergency spillways should be sized to safely pass flows that exceed the design storm flows. The spillway prevents pond water levels from overtopping the embankment, which could cause structural damage to the embankment. The emergency spillway should be located so that downstream buildings and structures will not be negatively impacted by spillway discharges. The pond design should include a low flow drain to assist in pond maintenance. The drain pipe should be designed for gravity discharge and should be equipped with an adjustable gate valve.

The design of the pond embankment is another key factor to be considered. Proper design and construction of the embankments will prolong the integrity of the pond structure. Seepage through the

embankment can also affect the stability of the structure. Seepage can generally be minimized by adding drains, anti-seepage collars, and core trenches. The embankment side slopes can be protected from erosion by using minimum side slopes of 3:1 and by covering the embankment with vegetation or riprap. The embankment should also have a minimum top width of ten feet if the embankment is used to provide drivable access for maintenance.

Low-Flow Channels:

A low flow channel routes the last remaining runoff, dry weather flow and groundwater to the outlet. A low flow channel should be installed in the basin to ensure that the basin dries out completely between storm events. Low flow channels also serve to prevent erosion of the pond as runoff first enters the pond. Pervious or impervious channel lining may be used. A pervious lining allows interaction of the runoff with the soil and grass, resulting in increased sorption of pollutants. Design velocities in pervious low flow channels should be high enough to prevent sedimentation and low enough to prevent scouring and erosion. No minimum low flow channel velocity is needed if a forebay is utilized prior to the low flow channel. The maximum flow velocity is dependent on the nature of the material used to line the channel.

Enhancement Options:

In some cases, it may be desirable to design a dry pond to provide water quality treatment. This might be beneficial in cases where other types of treatment are not available or practical, or when utilizing the pond for water quality works well for a particular site. The enhancement options discussed in this section should be incorporated for dry ponds used for water quality treatment.

Sediment Forebay:

The treatment efficiency of a dry pond can be increased by incorporating a forebay into the pond design. A sediment forebay facilitates maintenance and improves pollutant removal by trapping larger particles near the inlet of the pond. The forebay should include a deep permanent pool (greater than three feet) to minimize the potential for scour and re-suspension.

Extended Storage:

Traditional dry ponds have rarely been considered acceptable ponds from a water-quality perspective. The potential for scour and small detention times almost always eliminates these ponds from meeting water quality treatment goals. However, designs that eliminate scour by controlling the flow through the pond can provide acceptable treatment. Enhanced dry ponds that utilize extended storage principles can serve to meet water quality goals; however, they must be carefully and properly designed, implemented and maintained. To operate properly, these treatment systems need outlet controls with weirs or other energy-dissipation and flow-spreading devices constructed as part of the pond.

Micropool at the Outlet:

The performance of a dry pond can be enhanced through the provision of a micropool at the outlet. The micropool is typically relatively shallow and undrained. Its purpose is to concentrate finer sediment and reduce re-suspension. The micropool is normally planted with hardy wetland species.

Length to Width Ratio:

To maximize the water quality treatment potential of the pond, the inlet and outlet should be positioned in such a way that short-circuiting in the basin is minimized and the flow path length is maximized. This

generally means the inlet should be placed as far away from the outlet as possible. Ponds that are considerably longer than wide will likely provide additional detention time for settling and biological treatment. The desired flow path in a pond is generally described by the length to width ratio for the design storage volume. Length to width ratios of 3:1 or greater are preferred. Berms, baffles, and curved flow paths can be used to promote settling efficiency and avoid short circuiting by increasing the length to width ratio and redirecting flows at certain elevations.

Construction and Sequencing:

- A. Dry ponds may be constructed in the early phases of a development project, in order to treat site runoff during construction.
- B. If the basin is used as a sediment trap during construction, all sediment deposited during construction shall be removed before normal operation begins.
- C. The pond's contributing area should be stabilized as soon as possible to minimize sediment inflow and prolong the life and function of the pond.

Maintenance Access:

- A. Maintenance access is required to all portions of a pond that will require maintenance. This includes but is not limited to inlets and outlet, and in most cases, the pond floor for vegetation maintenance. The designer is required to consider maintenance activities and provide access for appropriate maintenance equipment in the design. This should involve consulting the appropriate maintenance entity to discuss equipment and access needs.
- B. The maintenance access features of the pond will depend largely on the pond configuration, site configuration, and type of equipment needed. Common maintenance access features include a drivable roadway to the inlet and outlet structures and drivable access to the facility floor.

Maintenance:

- A. Maintenance is required for the proper operation of dry ponds. Plans for dry ponds should identify owners, parties responsible for maintenance, and an inspection and maintenance schedule for extended storage ponds.
- B. Once constructed, the dry pond should be inspected after several storm events to confirm drainage system functions, bank stability, and vegetation growth. The outlet structure should be inspected for evidence of clogging or outflow release velocities that are greater than design flow. Problems should be addressed immediately.
- C. At least twice during the growing season, accumulated trash and debris should be removed from the side slopes, embankment, and emergency spillway. Accumulated sediment in the forebay should also be inspected at this time.
- D. Maintenance of vegetation, including mowing grass, should occur regularly.
- E. Dry ponds should be inspected at least once per year to ensure that they are operating as designed. Potential problems that should be checked include: subsidence, erosion, cracking or tree growth on the embankment; damage to the emergency spillway; sediment accumulation around the outlet; inadequacy of the inlet/outlet channel erosion control measures; changes in the condition of the pilot channel; and erosion within the basin and banks. Any necessary repairs should be made immediately. During inspections, changes to the dry pond or the

- contributing watershed should be noted as these may affect basin performance.
- F. Sediment should be removed from the pond as necessary. The frequency of sediment removal depends on the years of sediment accumulation that were incorporated into the design of the pond's forebay. Typically the required frequency is reduced after the initial removal which is generally required five to seven years after construction.
 - G. Because these types of basins do not have as much sediment storage volume as a typical wet dry pond, they need to be maintained more regularly, especially if extended detention is incorporated into the dry pond design. This usually increases the maintenance cost of the project.
 - H. In most cases, no specific limitations have been placed on disposal of sediments removed from dry ponds. Studies to date indicate that pond sediments are likely to meet toxicity limits and can be safely disposed of in a landfill. On-site sediment disposal is always preferable (if local authorities permit it) as long as the sediments are deposited away from the shoreline to prevent their re-entry into the pond and away from recreation areas where people could inhale resulting dust.
 - I. Sediments should be tested for toxicants in compliance with current disposal requirements if land uses in the catchment include commercial or industrial zones, or if visual or olfactory indications of pollution are noticed.

Table 6.6-11: Summary of Maintenance Activities for Dry ponds

Activity	Frequency*
Routine inspections (for the first few months on-line)	After every significant rainfall
Routine inspections (after the first few months online)	Once a year
Sediment removal	As needed
Trash and debris removal	Twice a year (during growing season)
Maintenance of vegetation and mowing of grass	As needed

**Alternate maintenance schedules may be submitted for approval for projects within municipal ROW. Coordinate with Street Maintenance and PM&E.*

6.6.10 Oversized Pipes

<p>Description</p> <p>An oversized pipe system that is designed to reduce peak flow rates by providing temporary, subsurface storage of stormwater runoff. The system is essentially a large pipe that has a small outlet at its invert.</p>																									
<p>Stormwater Management Suitability</p> <table> <tr> <td colspan="2">Runoff:</td> <td rowspan="2">Suitable to meet or help meet requirements for:</td> </tr> <tr> <td>Rate Control:</td> <td>High</td> </tr> <tr> <td>Volume Reduction:</td> <td>Low</td> <td>Detention ✓</td> </tr> <tr> <td colspan="3">Implementation Considerations:</td> </tr> <tr> <td>Land Requirement:</td> <td>Low</td> <td></td> </tr> <tr> <td>Capital Cost:</td> <td>High</td> <td></td> </tr> <tr> <td>Accepts Hotspot Runoff:</td> <td>Yes¹</td> <td></td> </tr> <tr> <td>Maintenance:</td> <td>Low</td> <td></td> </tr> </table>			Runoff:		Suitable to meet or help meet requirements for:	Rate Control:	High	Volume Reduction:	Low	Detention ✓	Implementation Considerations:			Land Requirement:	Low		Capital Cost:	High		Accepts Hotspot Runoff:	Yes ¹		Maintenance:	Low	
Runoff:		Suitable to meet or help meet requirements for:																							
Rate Control:	High																								
Volume Reduction:	Low	Detention ✓																							
Implementation Considerations:																									
Land Requirement:	Low																								
Capital Cost:	High																								
Accepts Hotspot Runoff:	Yes ¹																								
Maintenance:	Low																								
<p>Key Considerations</p> <p>Advantages:</p> <ul style="list-style-type: none"> • Can be very effective in reducing peak runoff flows from small sites • Can be used in sites with insufficient space to construct larger facilities • Can be useful in retrofit projects <p>Limitations:</p> <ul style="list-style-type: none"> • Provides little or no water quality treatment of runoff • High material costs relative to traditional surface storage facilities <p>• Must be located in areas where the pipes can be easily accessed for maintenance</p> <p>Design:</p> <ul style="list-style-type: none"> • Slopes should be kept to a minimum • Best applied to areas with relatively shallow slopes • Oversized pipe systems may include an inlet/outlet structures, emergency overflows and access points 																									

(1) Hotspot runoff still requires treatment.

Description:

Oversized pipes are designed to reduce peak flow rates by providing temporary, subsurface storage of stormwater runoff. An oversized pipe system is essentially a large pipe that has a small outlet at its invert. When inflow rates are larger than the outflow rates in this pipe series, runoff is detained within the pipes. Generally, detention times are in the order of a few hours. Like detention basins, oversized pipes are

designed to empty out between runoff events so that storage capacity is available for subsequent runoff events. See Figure 6.6-12 for a simple oversized pipe schematic.

Figure 6.6-12: Oversized Pipe Schematic

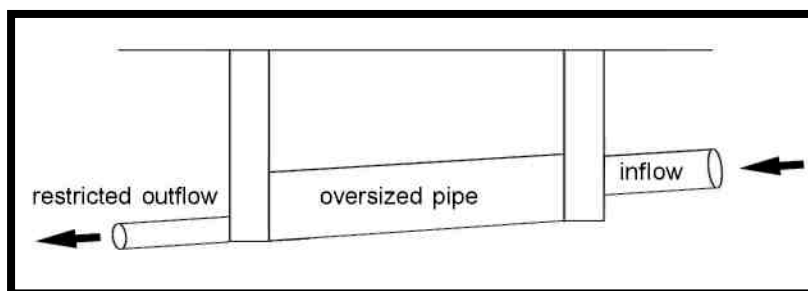

Source: *Minnesota Urban Small Sites Manual, 2001*

Oversized pipes are designed to fully drain, and water quality improvements should not be expected. Only some of the coarser sediment particles will settle out in the pipes, but can be re-suspended by incoming flows if they are not removed before the next storm event.

Oversized pipes are a retrofit alternative for existing storm drains in the upper portions of the drainage system. They lower the peak discharge rate and provide a limited amount of additional temporary storage volume. However, a careful analysis of the storm drainage system is necessary in order to prevent water backup and flooding in the upper reaches of the drainage area.

Generally, oversized pipes are utilized for small development sites where there is insufficient surface space to construct detention facilities. Other underground structures, such as underground detention vaults, can be used to accomplish the same objectives.

Some proprietary versions of this system exist in the form of manifold pipe systems. In this type of system, water flows from a catch basin or storm drain pipe into several pipes in parallel before out flowing to the larger system, as illustrated in Figure 6.6-13.

Advantages:

- A. Can be very effective in reducing peak runoff flows from small sites.
- B. Can be used in sites with insufficient space to construct larger, traditional types of detention facilities.
- C. Can be useful in retrofit projects.

Limitations:

- A. Provides little or no water quality treatment of runoff.
- B. High material costs relative to traditional surface storage facilities.
- C. Must be located in areas where the pipes can be easily accessed for maintenance.

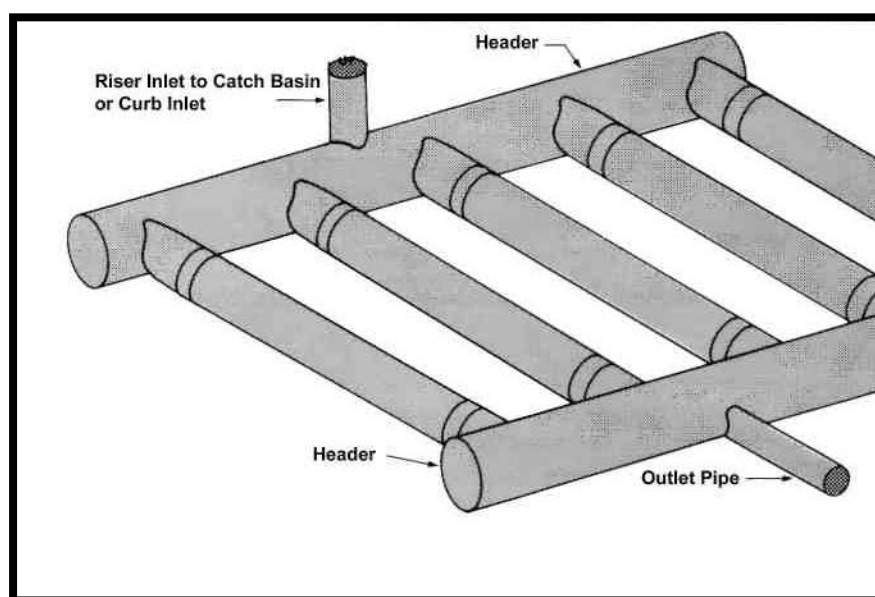
Figure 6.6-13: Manifold Underground Detention System

Source: *Minnesota Urban Small Sites Manual, 2001*

Design:

Oversized pipes should be installed where they can be easily accessed for maintenance. Subsurface locations include parking lots, grassed swales, adjacent to property boundaries, upper portion of catchment areas, etc. Oversized pipes should not be constructed under structures that cannot be excavated.

Pretreatment for Sediment:

Because oversized pipes are designed to hold and store water for a specified time period, the pipes do not maintain self-cleaning velocity the way a normal storm drain conveyance pipe does, and sediment can accumulate in the pipe. Pretreatment for sediment removal is recommended upstream of oversized pipes in order to help reduce the maintenance requirements and improve long-term life of the facility.

Inlets and Outlets:

Inlets and outlets must be sized for each structure. Outflow rates should be defined in a drainage plan or a storm drain analysis. Generally, inlets are sized to convey frequent runoff events from paved surfaces, as in the typical stormwater design. Outlets are much smaller pipes. The size and configuration of the outlet should be designed to restrict flows to the allowable discharge rate based on applicable Stormwater Management Requirements.

If an orifice is used in the design of the outlet, the minimum allowable orifice diameter is 2-inches, unless approval is granted by the relevant maintenance entity. If maintenance approval is granted, the minimum orifice size is 1-inch. All orifice outlets require protection to protect the orifice from clogging due to debris. Even small pieces of debris can clog a 1 or 2-inch orifice, and care should be taken to minimize this risk. If screens are used as a means to prevent clogging, the screen is required to be upstream of the orifice and have sufficient surface area that common amounts of leaves and debris cannot immediately clog the screen. Small screens placed over the orifice opening are not acceptable. Proper function of the orifice is dependent on the opening remaining unclogged, and the orifice will require maintenance. The designer

is encouraged to consult the appropriate maintenance entity for input on orifice design.

Length and Diameter:

The length and diameter of the oversized pipe are a function of the storage required to meet the allowable discharge rates. Generally, sizing the oversized pipe involves a standard hydraulic analysis- comparing the incoming flow to the desired outgoing flow to obtain the storage needed in the pipe. Maximum pre-manufactured diameters are approximately 10 feet and are generally dependent on the diameter that can be transported by truck to the site. Minimum diameters and maximum lengths shall be in accordance with the requirements for storm drain main lines, as discussed in Section 5.

Slope:

Slopes of the oversized pipe should be in accordance with the minimum allowable storm drain slopes discussed in Section 5 (0.3 percent). Some slope must be maintained to completely drain the pipe. Slopes should be kept to a minimum as steep slopes will reduce the amount of storage available within the pipe.

Emergency Overflows:

Emergency overflow paths should be located and sized to convey the 100-year runoff in case the oversized pipe (inlet/outlet) becomes plugged or inoperable.

Access Points:

At a minimum, personnel access points should be located at the upstream and downstream ends of the oversized pipe. Additional, intermediate locations are required in accordance with the requirements for storm drain pipe presented in Section 5.

Construction and Sequencing:

- A. Sequencing for installation of the oversized pipes should progress with the installation of the storm drain system.
- B. Inlet protection for sediment control should be installed immediately after each storm drain inlet is completed. This will minimize costs and delays of removing large quantities of sediment from the pipes during construction.

Maintenance:

- A. For safety, confined space entry procedures must be followed by maintenance personnel when removing sediments.
- B. Sediment should be removed from the pipe and not flushed downstream. This should be performed by access through the manholes as needed or twice per year.
- C. If flushing is the only cleaning option, special care should be taken to trap and remove sediment before it moves downstream.
- D. Check integrity and function of outlet structure as needed or twice per year.
- E. Follow maintenance requirements for storm drain pipe.

Table 6.6-12: Summary of Maintenance Activities for Oversized Pipes

Activity	Frequency*
Check integrity and function of outlet structure	As needed or twice per year
Remove sediment from pipe system	As needed or twice per year

**Alternate maintenance schedules may be submitted for approval for projects within municipal ROW. Coordinate with Street Maintenance and PM&E.*

6.6.11 Filter Strips

<p>Description</p> <p>A densely vegetated, uniformly graded area that treats sheet flow from adjacent impervious surfaces.</p>															
<p>Stormwater Management Suitability</p> <p>Runoff:</p> <table> <tr> <td>Rate Control:</td> <td>Low - Moderate¹</td> <td rowspan="2"> <p>Suitable to meet or help meet requirements for:</p> <p>Water Quality Treatment through Green Infrastructure ✓</p> <p>Pre-treatment ✓</p> </td> </tr> <tr> <td>Volume Reduction:</td> <td>Low - Moderate¹</td> </tr> </table> <p>Implementation Considerations:</p> <table> <tr> <td>Land Requirement:</td> <td>Moderate</td> </tr> <tr> <td>Capital Cost:</td> <td>Low</td> </tr> <tr> <td>Accepts Hotspot Runoff:</td> <td>No²</td> </tr> <tr> <td>Maintenance:</td> <td>Low</td> </tr> </table>			Rate Control:	Low - Moderate ¹	<p>Suitable to meet or help meet requirements for:</p> <p>Water Quality Treatment through Green Infrastructure ✓</p> <p>Pre-treatment ✓</p>	Volume Reduction:	Low - Moderate ¹	Land Requirement:	Moderate	Capital Cost:	Low	Accepts Hotspot Runoff:	No ²	Maintenance:	Low
Rate Control:	Low - Moderate ¹	<p>Suitable to meet or help meet requirements for:</p> <p>Water Quality Treatment through Green Infrastructure ✓</p> <p>Pre-treatment ✓</p>													
Volume Reduction:	Low - Moderate ¹														
Land Requirement:	Moderate														
Capital Cost:	Low														
Accepts Hotspot Runoff:	No ²														
Maintenance:	Low														
<p>Key Considerations</p> <p>Advantages:</p> <ul style="list-style-type: none"> • Helps remove sediment and associated insoluble contaminants from runoff • Relatively simple and inexpensive to install • Works well in residential areas • Helps maintain temperature norms of the water • Acceptable in areas with high groundwater that precludes use of Bioretention <p>Limitations:</p> <ul style="list-style-type: none"> • Not appropriate for hilly or intensively paved areas • Only effective if sheet flow can be maintained through the filter strip • Difficult to monitor effectiveness • Not suitable for contributing drainage areas greater than one acre <p>Design:</p> <ul style="list-style-type: none"> • The length of the filter strip should stretch the entire length of the impervious surface from which stormwater originates • Top and toe of slope should be as flat as possible to encourage sheet flow and prevent erosion 															

(1) Increased performance when level spreaders are incorporated into the design.

(2) Yes, if pretreatment is provided.

General Description:

Filter strips (also known as vegetated filter strips, biofiltration strips, and grass filter strips) are densely vegetated, uniformly graded areas that treat sheet flow from adjacent impervious surfaces. Filter strips

function by slowing runoff velocities, trapping sediment and other pollutants, and providing some infiltration. While frequently planted with turf grass, filter strips may also employ native vegetation, which may be more effective in treating nutrients. In addition, trees and shrubs may be incorporated into portions of the strip to create visual screening as well as a physical barrier. For further details, see Figure 6.6-14.

Filter strips are best suited to treating runoff from roads and highways, roof downspouts and small parking lots, and they are ideal components of the "outer zone" of a stream buffer. In addition, filter strips are frequently used as a pretreatment system for stormwater destined for other low impact development systems such as filters or bioretention systems.

A challenge associated with filter strips is the difficulty of maintaining sheet flow. Urban filter strips are often short circuited by concentrated flows, which results in little or no treatment of stormwater runoff. To avoid this problem, filter strip design can incorporate a level spreader to distribute concentrated flow along the width of the strip.

Advantages:

- A. Filter strips help remove sediment and associated insoluble contaminants from runoff.
- B. They allow increased infiltration opportunity for soluble nutrients and pesticides to drain into the soil.
- C. Filter strips work well in residential areas, where they provide open space for recreation activities, help maintain riparian zones along streams, reduce streambank erosion and provide animal habitat.
- D. Since they do not pond water on the surface for long periods, filter strips help maintain temperature norms of the water, thereby protecting or providing habitat for aquatic life.
- E. Filter strips can be useful as sediment filters during construction. In some settings, this may only require preservation of an appropriately located area of existing vegetation. (See Design section for details.)
- F. Filter strips with taller, dense vegetation can help provide a visual barrier from such areas as roads, factories, or recreation sites.
- G. Filter strips with dense native vegetation can trap dust blowing off a construction site.
- H. They are relatively simple and inexpensive to install, employing only planting and perhaps some earthwork.
- I. Filter strips are relatively low-maintenance practices.
- J. They tend to be low-cost as well, since their plantings and maintenance often overlap with what would be done on the site regardless of stormwater management practices.

Figure 6.6-14 Filter Strip Conceptual Plan and Profile

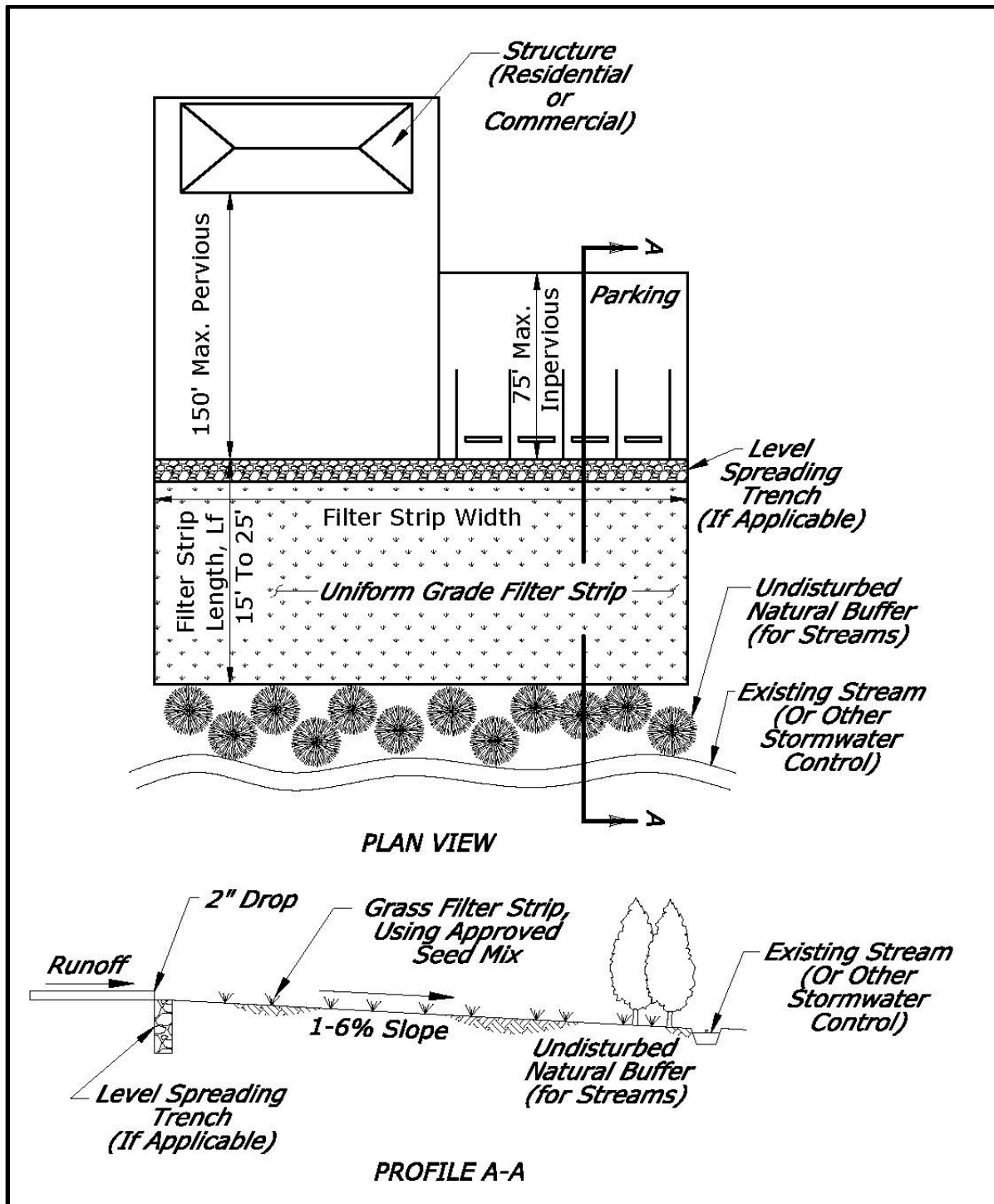

Source: Modified from MOA Low Impact Development Design Guidance Manual, 2008

Limitations:

- A. They are not appropriate for hilly or highly impervious areas due to high-velocity runoff.
- B. These systems are difficult to monitor, and thus there is less available data on their effectiveness for pollutant removal.
- C. Filter strips tend to be poor retrofit options since they consume a relatively large amount of space and cannot treat large drainage areas.
- D. Improper grading can render the practice ineffective.
- E. Since filter strips cannot provide enough storage or infiltration to significantly reduce peak discharge or volume of runoff, the practice may be best implemented as one of a series of stormwater systems.
- F. Filter strips are only effective if sheet flow can be maintained through the filter strip.

Design:*Site Sensitivity Analysis*

- A. Filter strips are intended to treat runoff from urban and suburban drainage areas where pollutant loads come from residential, parking, and road surface runoff. Filter strips are not appropriate to receive runoff from industrial facilities or from areas where runoff is likely to contain industrial pollutants.
- B. Filter strips are suitable to treat small drainage areas, generally one acre or less in size. It is possible to treat runoff from large areas if multiple filter strips are used. For effective performance, runoff must enter the filter strip as sheet flow. Runoff tends to concentrate within 75 feet along impervious surfaces and within 150 feet along pervious surfaces. Longer flow paths upstream of filter strips are acceptable, but require special consideration to ensure design flows are spread evenly across the surface of the filter strips.
- C. The contributing drainage area slopes should be less than 10 percent for effective performance. Steeper slopes require additional energy dissipation to promote the dispersion of stormwater evenly across the length of the filter strips and to prevent erosion. Slopes parallel to the flow path across filter strips should be between one and six percent.
- D. Ordinarily, forests and other natural areas should not be destroyed to create a filter-strip system. Such areas may already be functional or may only need to be enhanced (with, for example, level spreaders or repair to eroded spots) to function properly as treatment systems.
- E. In most cases, the filter strip width should stretch the entire width of the area from which it is receiving runoff. When adjacent to a natural water body, the width should span the entire property line or shoreline.

*General Design Considerations:***Slope-**

Filter strip slopes should generally range from one percent to six percent for effective performance. Slopes at the top and toe of filter strips should be as flat as possible to encourage sheet flow and prevent erosion. The maximum allowable lateral slope (perpendicular to the direction of flow) for filter strips should not exceed one percent. Top and toe of slope should be

as flat as possible to encourage sheet flow and prevent erosion.

Flow Depth-

Flow depths on filter strip surfaces should not exceed 0.5 inches. At depths greater than 0.5 inches, treatment through filtration is reduced as deeper flows tend to push filter strip grasses parallel to the ground.

Discharge Loading-

The maximum discharge load represents the maximum flow rate that can cross the threshold of a filter strip without compromising the filter strip performance. The maximum discharge loading refers to the flow entering the filter strip. The calculation of maximum discharge loading per foot width along the filter strip is based on Manning's equation.

$$q = \frac{1.49}{n} * \left(\frac{Y}{12} \right)^{\frac{5}{3}} * S^{\frac{1}{2}}$$

Where:

q = Volumetric Discharge per Foot Width (cubic feet/second-foot)

Y = Maximum Allowable Depth of Flow (inches)

S = Slope of Filter Strip (feet/foot)

n = Manning's "n" Roughness Coefficient for sheet flow. This value is equal to 0.2 for mowed grass and 0.25 for unmowed grass. If using other vegetation rather than turf grass, appropriate roughness coefficients should be selected based on literature. (See Table 4.6-2)

Velocity-

The maximum allowable design velocity is the minimum allowable velocity along the filter strip under normal design conditions. The maximum allowable velocity for filter strips is 0.9 fps. This is based on the calculated volumetric discharge per foot width and the design flow depth. The maximum allowable design flow depth is 0.5 inches. The design velocity can be calculated using the following formula.

$$V = \frac{q}{Y / 12}$$

Where:

V = Velocity (feet/second)

q = Volumetric Discharge per Foot Width (cubic feet/second-foot)

Y = Maximum Allowable Depth of Flow (inches)

Width-

As described earlier in this section, the width of a filter strip should normally extend the entire width of the area from which it is receiving flow. However, in cases where this is not practical, such as when a level spreader is being used (see discussion of leveling spreading devices in this section), it may be necessary to calculate the appropriate filter strip width.

The minimum width (W_{fp}) of a filter strip, which is the dimension perpendicular to flow, is a function of flow rate entering and exiting the filter strip, and the filter strip design depth.

$$W_{fp} = \frac{Q}{q}$$

Where:

W_{fp} = Width of Filter Strip Perpendicular to Flow Path (feet)

Q = Rate of runoff directed toward the filter strip. This should be calculated using the rational equation with a peak intensity for the water quality event of 0.12 inches per hour.

q = Volumetric Discharge per Foot Width (cubic feet/second-foot)

Length-

For a given site, filter strip length, parallel to the direction of flow, is dependent on slope and vegetative cover. Generally, filter strips should extend a minimum of 15 feet in the direction of flow, with 25 feet preferred if space is available. When filter strips are the primary system providing stormwater treatment, the ratio of contributing area to filter strip area should not exceed 6:1. Filter strip length should be calculated for a travel time of five to nine minutes according to the Soil Conservation Service (SCS) Technical Release 55 (TR-55) travel time equation (SCS, 1986) shown below.

$$L_f = \frac{T_t^{1.25} * P^{0.625} * (S * 100)^{0.5}}{3.34 * n}$$

Where:

L_f = Length of Filter Strip Parallel to Flow Path (feet)

T_t = Travel Time through Filter Strip (minutes)

P = 2-year, 24-hour Precipitation depth (inches), as presented in Section 4 of this manual. (This is an SCS parameter used to calibrate this equation; the 2-year, 24-hour depth is used regardless of the design storm event.)

S = Slope of Filter Strip (ft/ft)

n = Manning's "n" Roughness Coefficient, equal to 0.2 for mowed grass and 0.25 unmowed grass

Vegetation-

Filter strip cover may consist of existing vegetation, hearty native vegetation, planted turf grasses, or a mixture of grasses and shrub vegetation. Optimal vegetation arrangements incorporate plants with dense growth patterns, fibrous root systems for stability, and adaptability to local soil and climatic conditions. Additional guidance with selecting non-invasive plant species appropriate for filter strips is presented in Appendix E.

Level Spreading Devices-

Level spreading devices installed upstream of filter strips produce uniform sheet flow conditions along the entire leading edge of the filter strip, and help prevent concentration of flows that create erosive conditions. Level spreading devices are required when sheet flow cannot be achieved through direct inflow from the receiving area. (See Figure 6.6-15) Level spreaders have a number of different configurations with one common function – to spread concentrated flow into sheet flow upstream of filter strips. The following examples describe common features and

applications of three types of level spreading devices.

- 1) Level Spreading Trench. A level spreading trench consists of a gravel-filled trench installed along the entire leading edge of a filter strip. Gravel can range in size from pea gravel to shoulder ballast for roadways. Level spreading trenches typically have widths of 12 inches and depths of 24 to 36 inches, and they typically use nonwoven geotextile linings. A one-inch to two-inch drop between the adjacent impervious surface and the edge of the trench inhibits the formation of an initial deposition barrier. In addition to acting as a level spreader, these trenches also act as pretreatment devices, allowing sediment to settle out before reaching the filter strip.
- 2) Earthen Level Spreader/Natural Berms. Shaping and grading of the area immediately upslope of a filter strip into a berm can also promote uniform sheet flow conditions. This method has a more natural appearance, though the berms can fail more readily than other devices due to irregularities in berm elevation and density of vegetation that may grow over time. For example, this type of level spreader could be used roadway runoff that is collected in a ditch that overflows to a filter strip for treatment.
- 3) Swale with Concrete Spreader. If a level spreader receives stormwater from a pipe or other conveyance, a swale in conjunction with a concrete level spreader should be considered (See Figure 6.6-15). When the swale fills, water disperses evenly along the length of the level spreader. Concrete level spreaders resist erosion better than level spreaders made of earth, gravel, or both. If a flow greater than the design flow is routed over a level spreader made of concrete, the level spreader lip will not be damaged. Another stable material is a metal gutter. Like concrete level spreaders, pre-fabricated metal level spreaders can be expected to remain level with minimal maintenance.

Ideally, the lip of the concrete level spreader should be higher than the existing ground by 3 to 6-inches. This allows water to pass over the lip without interference from buffer vegetation. To limit any erosion that could occur as water falls from the top of the level spreader to the existing soil, a layer of geotextile fabric should be extended a distance of 3 feet from the level spreader lip towards the buffer. Stone should be placed on top of the geotextile fabric (3 to 4 inches deep) to reduce erosion just down slope of the level spreader. A 3-foot wide strip of erosion control matting can be used in place of the geotextile fabric and stone combination. However, such an area must be stable and have adequate vegetation before receiving stormwater.

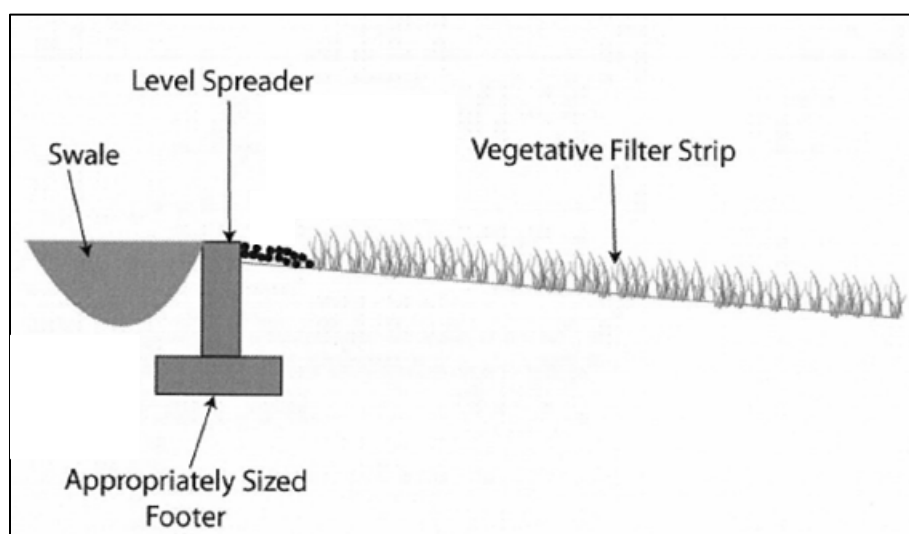
Figure 6.6-15: Sample Cross Section of Concrete Level Spreader

Source: *Urban Waterways Level Spreader Update: Design, Construction, and Maintenance, 2006*

Construction:

- A. Accurate grading is essential, since even small departures from design slopes can eliminate sheet flow and decrease effectiveness.
- B. If a filter strip must be interrupted by construction entrances, resulting in removal of natural vegetation, artificial buffer techniques must be installed: for example, vehicle tracking pads or silt fences.
- C. When a filter strip is used during construction, its design should be incorporated into the final post-construction landscape. This may mean selecting vegetation that will reach an appropriate height at maturity and offer an attractive appearance.

Maintenance:

With appropriate maintenance, filter strips can be effective indefinitely. Those that are not maintained properly may quickly become nonfunctional. Maintenance involves normal grass or shrub-growing activities such as mowing, trimming, removal of invasive species, and replanting when necessary.

Filter strips require more tending as the volume of sediment increases. Periodically, strips used for sediment removal may require reregarding and reseeding of their upslope edge. When used during construction activities, and if a high volume of sediment builds up, the strip may need to be reworked and replanted. The same would be necessary if concentrated flow erodes a channel through the strip. Designers should consider the buildup of sediments and sand, particularly if the filter strip will be treating runoff from sanded surfaces, such as roads. Over time, if it is not removed, sand can build up and change the flow elevation of a filter strip. The sediment load and frequency of sediment removal should be considered when the elevation of the filter strip is determined.

Fertilizer application for filter strips should be limited based on plant vigor and soil test results.

Suggested maintenance recurrence is provided in the table below.

Table 6.6-13: Summary of Maintenance Activities for Filter Strips

Activity	Frequency*
Mowing, trimming, removal of invasive species, and replanting	As needed
Inspect pea gravel diaphragm/ level spreader for clogging and remove built-up sediment	Once a year (Twice in first year)
Inspect for rills and gullies. Fill with topsoil, install erosion control blanket, and seed or sod	Once a year (Twice in first year)
Inspect establishment of grass	Once a year (Twice in first year)
Remove sediment and replant in areas of buildup	As needed

**Alternate maintenance schedules may be submitted for approval for projects within municipal ROW. Coordinate with Street Maintenance and PM&E.*

6.6.12 Constructed Wetlands Constructed Wetlands

<p>Description</p> <p>A wetland designed to maximize the removal of pollutants from stormwater runoff via several mechanisms: microbial breakdown of pollutants, plant uptake (phytoremediation), retention, settling and adsorption.</p>																										
<p>Stormwater Management Suitability</p> <table border="0"> <tr> <td>Runoff:</td> <td></td> <td>Suitable to Meet Stormwater Management Requirement:</td> </tr> <tr> <td>Rate Control</td> <td>Moderate - High</td> <td>Water Quality Treatment through Green Infrastructure ✓</td> </tr> <tr> <td>Volume Reduction</td> <td>Moderate</td> <td>Detention ✓</td> </tr> <tr> <td>Implementation Considerations:</td> <td></td> <td>Wetland Mitigation ✓</td> </tr> <tr> <td>Land Requirement</td> <td>High</td> <td></td> </tr> <tr> <td>Capital Cost</td> <td>Low to High²</td> <td></td> </tr> <tr> <td>Accepts Hotspot Runoff</td> <td>Varies¹</td> <td></td> </tr> <tr> <td>Maintenance</td> <td>Low - Moderate</td> <td></td> </tr> </table>			Runoff:		Suitable to Meet Stormwater Management Requirement:	Rate Control	Moderate - High	Water Quality Treatment through Green Infrastructure ✓	Volume Reduction	Moderate	Detention ✓	Implementation Considerations:		Wetland Mitigation ✓	Land Requirement	High		Capital Cost	Low to High ²		Accepts Hotspot Runoff	Varies ¹		Maintenance	Low - Moderate	
Runoff:		Suitable to Meet Stormwater Management Requirement:																								
Rate Control	Moderate - High	Water Quality Treatment through Green Infrastructure ✓																								
Volume Reduction	Moderate	Detention ✓																								
Implementation Considerations:		Wetland Mitigation ✓																								
Land Requirement	High																									
Capital Cost	Low to High ²																									
Accepts Hotspot Runoff	Varies ¹																									
Maintenance	Low - Moderate																									
<p>Key Considerations</p> <p>Advantages:</p> <ul style="list-style-type: none"> • Improvements in downstream water quality • Settlement of particulate pollutants • Flood attenuation (for smaller events, higher events may be attenuated based on available space) • Enhancement of vegetation diversity and wildlife habitat in urban areas • Reduced temperature of stormwater discharged into receiving waterway (performs better than a retention basin) • Acceptable in areas with high groundwater that precludes the use of Bioretention <p>Limitations:</p> <ul style="list-style-type: none"> • Releases nutrients in the fall • May be difficult to maintain vegetation under a variety of flow conditions • May act as a heat sink, and can discharge warmer water downstream • Difficult to implement in urban areas due to large land requirements <p>Design:</p> <ul style="list-style-type: none"> • Best suited for draining large areas • Baseflow from the drainage area or groundwater must be sufficient to maintain a shallow pool in the wetland and support vegetation • Treatment areas may include a sediment forebay, buffer areas, above ground berms, inlet/outlet structures, a micro pool, access for maintenance and wetland vegetation • Type C and D soils are beneficial for water retention 																										

(1) Varies depending on facility design. Yes, if facility includes a liner or is not dependent on groundwater base flow and infiltration is limited.

(2) Capital cost is high if land costs are included.

General Description:

Stormwater wetlands are constructed wetland systems designed to maximize the removal of pollutants from stormwater runoff via several mechanisms: microbial breakdown of pollutants, phytoremediation, retention, settling, and adsorption. Stormwater wetlands temporarily store runoff in shallow pools that support conditions suitable for the growth of wetland plants. Stormwater wetlands also promote the growth of microbial populations which can extract soluble carbon and nutrients and potentially reduce biological oxygen demand (BOD) and fecal coliform concentrations.

Like detention and retention basins, stormwater wetlands may be used in conjunction with other stormwater controls, such as sediment forebays and micropools. Engineered stormwater wetlands differ from wetlands constructed for compensatory storage purposes and wetlands created for restoration. Typically, stormwater wetlands will not have the full range of ecological functions of natural wetlands; stormwater wetlands are designed specifically for flood control and water quality purposes. Similar to retention basins, stormwater wetlands require relatively large contributing drainage areas and/or dry weather base flow. Minimum contributing drainage areas should be at least ten acres, although pocket type wetlands may be appropriate for smaller sites if sufficient groundwater flow is available.

The use of stormwater wetlands is limited by a number of site constraints, including soils types, depth to groundwater, contributing drainage area, and available land area. Soils, depth to bedrock, and depth to water table must be investigated before designing and siting stormwater wetlands. Medium-fine texture soils (such as loams and silt loams) are best to establish vegetation, retain surface water, permit groundwater discharge, and capture pollutants. However, Type D soils may be acceptable due to increased retention times. At sites where infiltration is too rapid to sustain permanent soil saturation, an impermeable liner may be required. Where the potential for groundwater contamination is high, such as runoff from sites with a high potential pollutant load, the use of liners is required.

Advantages:

- A. Improvements in downstream water quality.
- B. Settlement of particulate pollutants.
- C. Reduction of oxygen-demanding substances and bacteria from urban runoff.
- D. Biological uptake of pollutants by wetland plants.
- E. Flood attenuation.
- F. Reduction of peak discharges and runoff volumes.
- G. Enhancement of vegetation diversity and wildlife habitat in urban areas.
- H. Aesthetic enhancement and valuable addition to community green space.
- I. Relatively low maintenance costs.

Limitations:

- A. May release nutrients in the fall.
- B. May be difficult to maintain vegetation under a variety of flow conditions.
- C. Geese population may be attracted and become undesirable if appropriate buffers are not included in the wetland design.
- D. May act as a heat sink, and can discharge warmer water to downstream water bodies.
- E. Depending upon design, larger land requirements; may not be an appropriate choice in urban environments.

- F. Until vegetation is well established, pollutant removal efficiencies may be lower than anticipated.
- G. As vegetation dies off, nutrients may be returned to the system unless periodic harvesting and replanting is included in the maintenance protocol.
- H. Relatively high construction costs.
- I. Weir elevation at downstream end must be set correctly for vegetation to flourish.
- J. Subject to short-circuiting if designed incorrectly.

Design:

A site appropriate for a stormwater wetland must have adequate water flow and appropriate underlying soils. Baseflow from the drainage area or groundwater must be sufficient to maintain a shallow pool in the wetland and support the vegetation, including species susceptible to damage during dry periods. Underlying soils that are NRCS Types C or D will have only small infiltration losses. Sites with type A (sandy) soils have high infiltration rates and may require a geotextile liner or a six inch layer of clay. After excavation and grading of a basin, at least four inches of soil should be applied to the site for all soil types. For some design, use of amended growing media formulated for wetlands vegetation may be used. This material, which may be the previously-excavated soil or other suitable material, is needed to provide a substrate in which vegetation can become established. It is possible to use plant material from a "borrow source" (sometimes called "peat blocks") to provide root stock and a seed bank to facilitate rapid regrowth. Also, the substrate that is transported with the plant material can provide instant filtration and storage capacity. It should be noted that after placement there is an initial release of organics as the disturbed material releases fines that are no longer held by roots as a result of damage or vibration from movement.

Wetland Treatment:

Stormwater wetlands can be designed to meet particle size removal efficiencies and treatment volume criteria. However, care must be taken to design the wetland so that the water level fluctuation or "bounce" in the pool is compatible with the wetland vegetation. The bounce must be considered in addition to any discharge requirements for particle size, flood control, or downstream settling ponds with special attention to keeping solids from overtaking the vegetation.

Factors which increase the settling rate of suspended solids in stormwater wetlands include:

1. Laminar settling in zero-velocity zones created by plant stems;
2. Anchoring of sediments by root structure, helping to prevent scour in shallow areas;
3. Increased biological activity removing dissolved nutrients; and
4. Increased biological floc formation.

Basic Stormwater Wetland Design Types:

Design criteria and other considerations for four wetland types are summarized in Table 6.6-14 and described in this section. Figures 6.6-20 shows the profile of each type of wetland described in this section.

Design Type One: Shallow Marsh System-

- A. Shallow marsh systems are configured with different low marsh and high marsh areas, which are referred to as cells. They also include a forebay for coarse particulate settlement before the wetland cell and a micropool at the outlet.
- B. Shallow marshes are designed with sinuous pathways to increase retention time and contact area.

- C. Most shallow marsh systems consist of pools ranging from 6 to 18 inches during normal conditions.
- D. Shallow marshes may require larger contributing drainage areas than other systems, as runoff volumes are stored primarily within the marshes, not in deeper pools where flow may be regulated and controlled over longer periods of time.

Figure 6.6-16: Shallow Marsh System

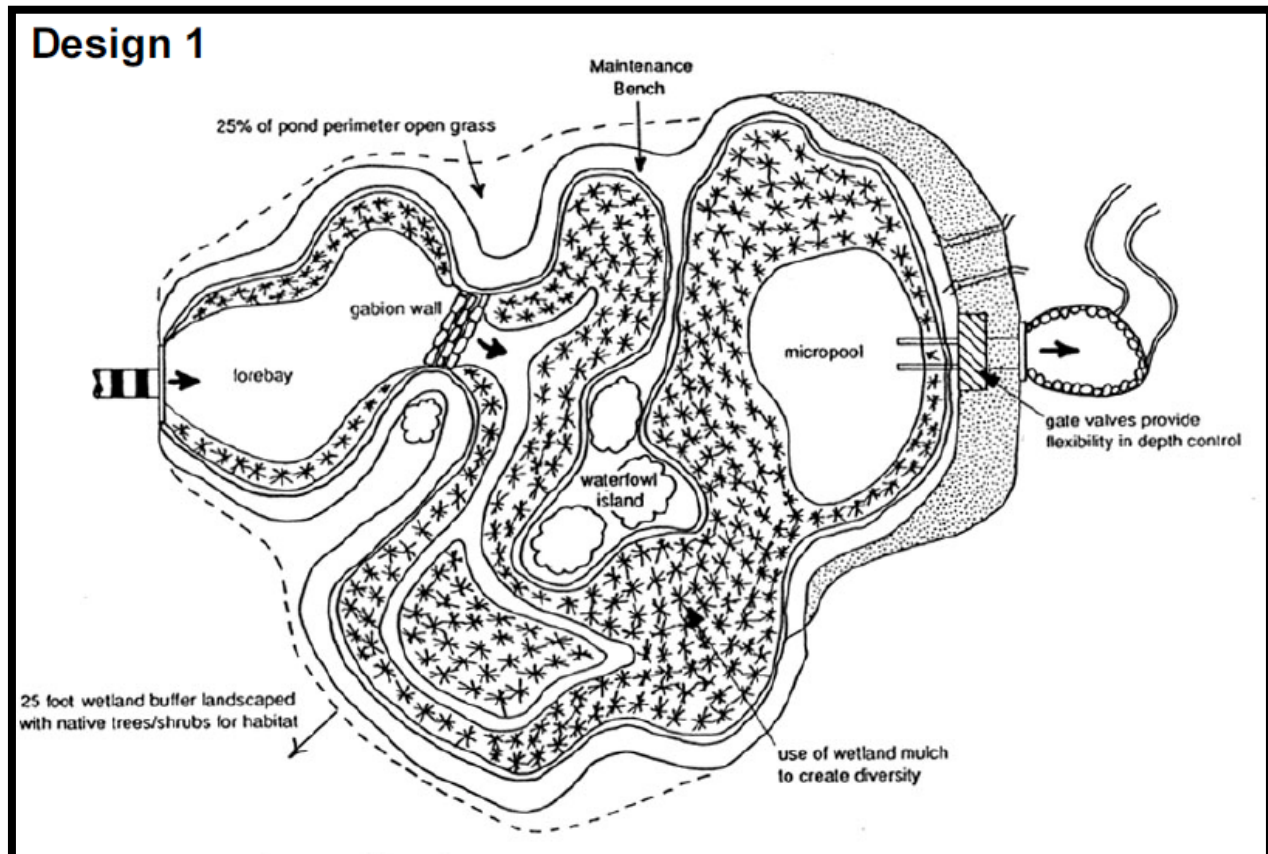

Source: *Minnesota Urban Small Sites Manual, 2001*

Design Type Two: Pond/Wetland Systems-

- A. Multiple cell systems, such as pond/wetland systems, utilize at least one pond component in conjunction with a shallow marsh component.
- B. The first cell is typically the retention basin which provides for particulate pollutant removal. The retention basin is also used to reduce the velocity of the runoff entering the system.
- C. The shallow marsh provides additional treatment of the runoff, particularly for soluble pollutants. These systems require less space than the shallow marsh systems and generally achieve a higher pollutant removal rate than other stormwater wetland systems.
- D. Design Type Two lends to the importation of vegetation in blocks of soil/root mass in order to induce rapid growth and instant rooting and seed bank (peat blocks).

Figure 6.6-17: Pond/Wetland System

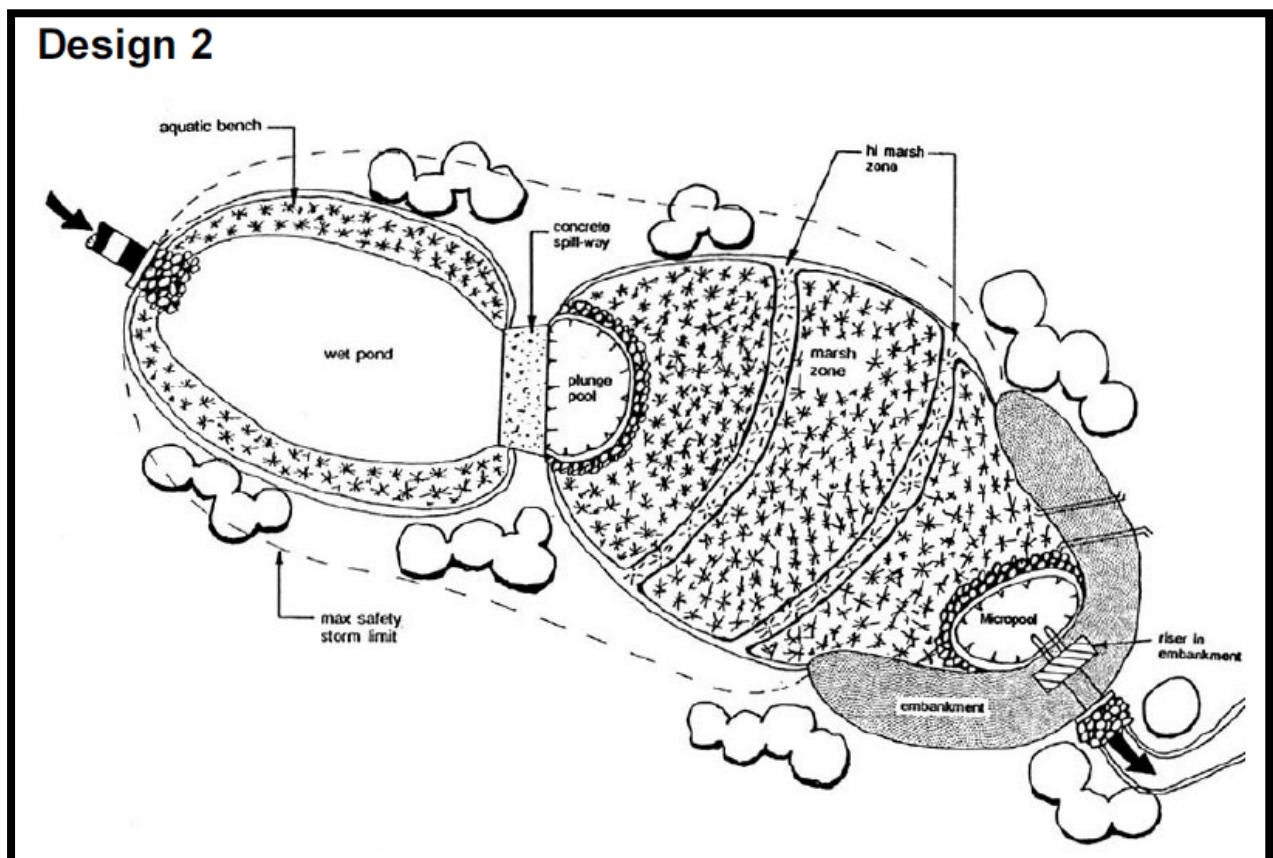

Source: Minnesota Urban Small Sites Manual, 2001

Design Type Three: Extended Detention Wetlands-

- A. Extended detention wetlands provide a greater degree of downstream channel protection. These systems require less space than the shallow marsh systems, since temporary vertical storage is substituted for shallow marsh storage.
- B. The additional vertical storage area also provides extra runoff detention above the normal elevations.
- C. Water levels in the extended detention wetlands may increase by as much as three feet after a storm event and return gradually to normal within 24 hours of the rain event.
- D. The vegetated area in extended detention wetlands expands from the normal pool elevation to the maximum surface water elevation.
- E. Wetlands plants that tolerate intermittent flooding and dry periods should be selected for the extended detention area above the shallow marsh elevations. Plantings should use a diverse number of species to allow the maximum success in the long term.

Figure 6.6-18: Extended Detention Wetland System

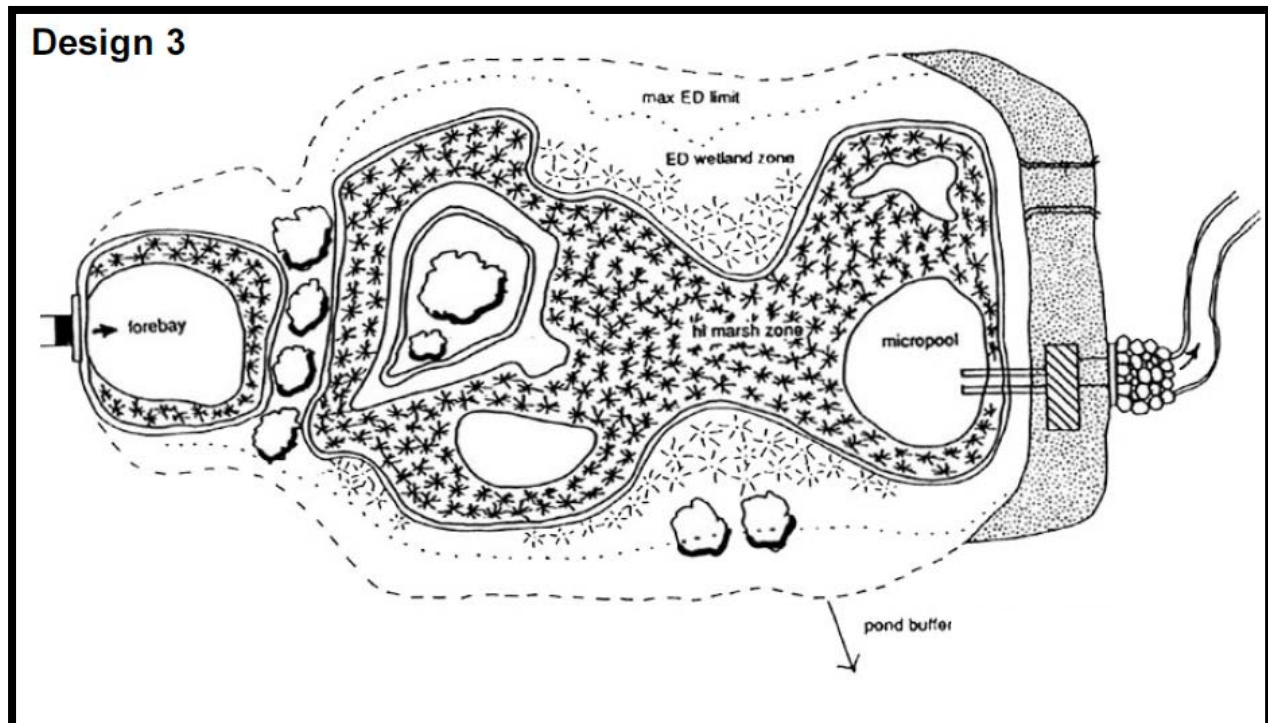

Modified from: Minnesota Urban Small Sites Manual, 2001

Design Type Four: Pocket Wetlands-

- A. These systems may be utilized for smaller sites of one to 10 acres.
- B. To maintain adequate water levels, pocket wetlands are generally excavated down to the groundwater table.
- C. Pocket wetlands which are supported exclusively by stormwater runoff generally will have difficulty maintaining marsh vegetation due to extended periods of drought.
- D. These are often located in commercial or residential areas. Consideration must be given to public travel and contact in and around the area to prevent damage of plant materials.

Figure 6.6-19: Pocket Wetland System

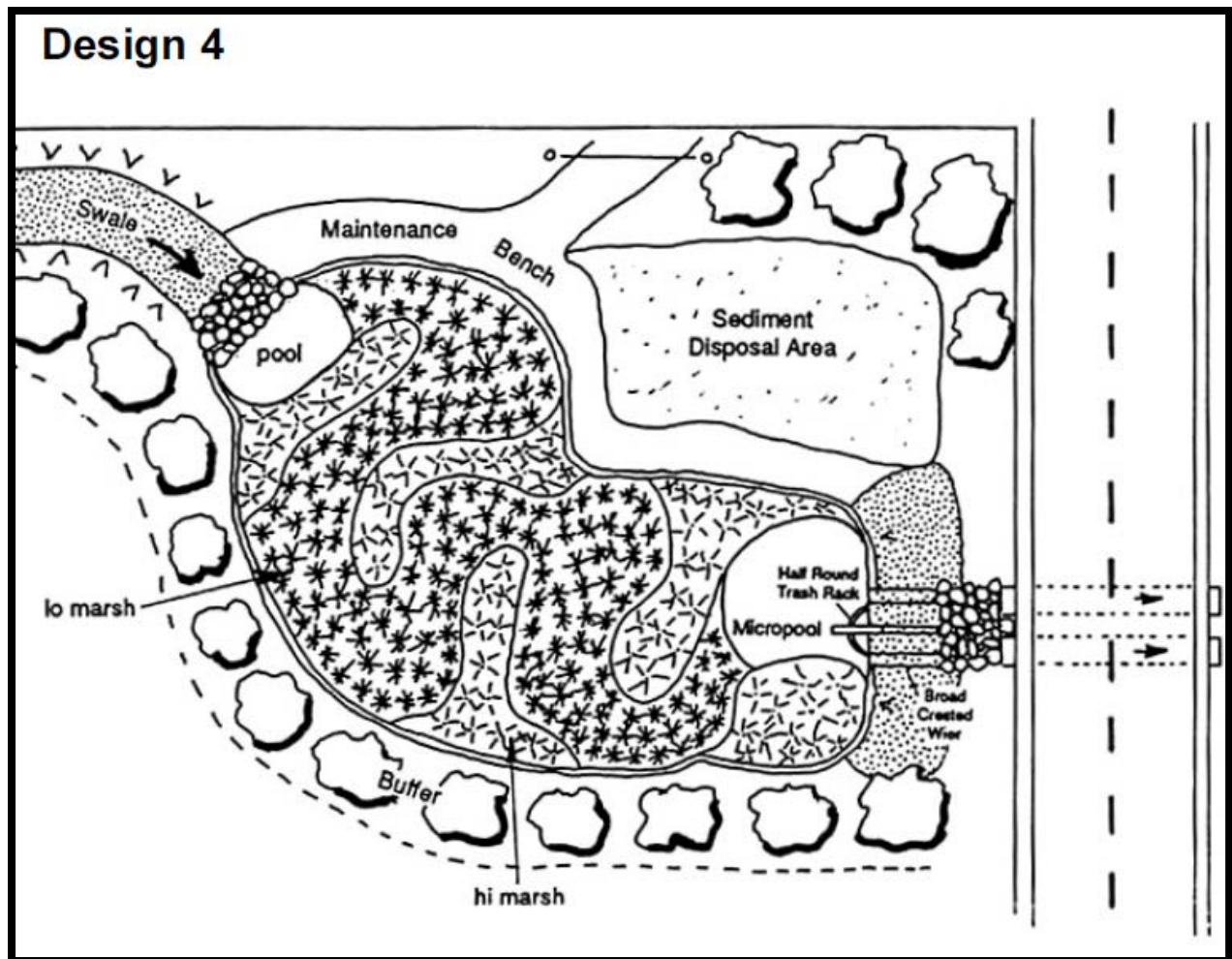

Source: Minnesota Urban Small Sites Manual, 2001

Table 6.6-14: Wetland Design Criteria

Design Criteria	Design 1: Shallow Marsh	Design 2: Pond/Wetland	Design 3: Extended Detention Wetland	Design 4: Pocket Wetland
Wetland/Watershed Ratio	0.02	0.01		
Minimum Drainage Area (acres)	25		10	
Length to Width Ratio (minimum)	1:01			
% Allocation of Treatment Volume (pool, marsh, extended detention)	40/60/0	70/30/0	20/30/50	20/80/0
% Allocation of Surface Area (deep, low marsh, high marsh)	20/40/40	45/25/30	20/35/45	10/40/50
Cleanout Frequency (years) ⁽¹⁾	2 to 5	10	2 to 5	10
Accommodation of Peat Block Installation	Limited	Good	Limited	Less desirable
Forebay	Required	No	Required	Optional
Micropool	Required			Optional
Buffer (feet)	25 to 50			0 to 25
Flow Path length to width ratio	1:01			NA
Dry Flow Path length to width ratio	2:01			
Water Balance	Confirm inflow rate > 0.002 cfs/acre, compute water balance during dry weather			Confirm dry weather water table elevation

(1) Cleanout frequency may be reduced after initial clean out if contributing areas have stabilized.

Source: Minnesota Urban Small Sites Manual, 2001

Figure 6.6-20: Comparative Profiles of the Four Stormwater Wetland Design

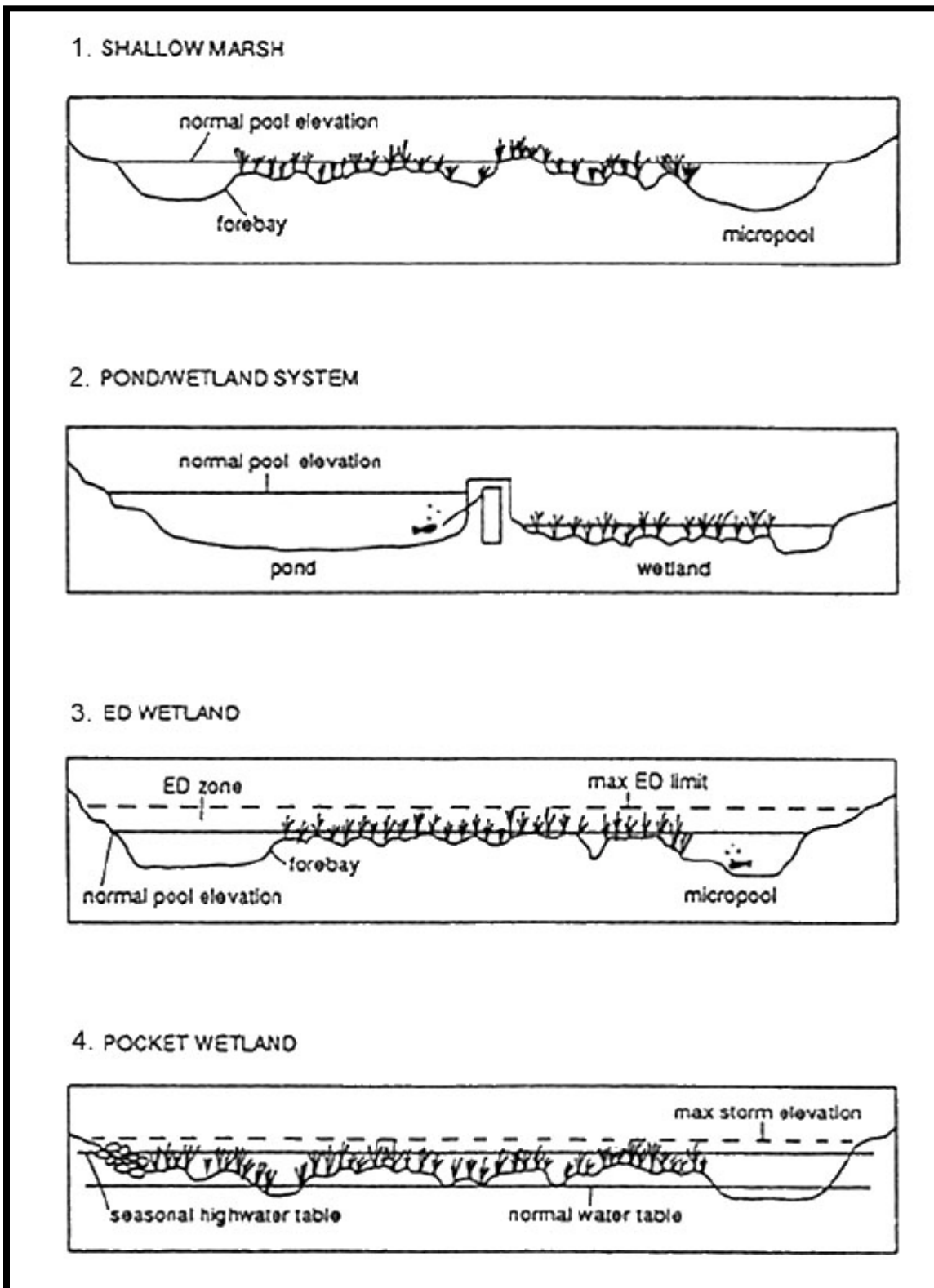

Source: Minnesota Urban Small Sites Manual, 2001

General Design Considerations:

- A. Sediment forebays are recommended to decrease the velocity and sediment loading to the wetland. The forebays provide the additional benefits of creating sheet flow, extending the flow path, and preventing short circuiting. The forebay should contain at least 10 percent of the wetland's treatment volume and should be four to six feet deep. The forebay is typically separated from the wetland by gabions, gravel/riprap, or an earthen berm.
- B. The wetland design should include a buffer to separate the wetland from surrounding land. Buffers may alleviate some potential wetland nuisances, such as accumulated floatables, odors, and/or geese.
- C. Geese feces increases BOD and fecal coliform levels and can create unhealthy conditions for human and pet contact. Tall grasses and vegetation at the wetland margin and in buffer areas provide hiding places for predators and will discourage goose habitation. Also, closely-planted shrubs with dense branching structure such as potentilla and thorns such as native rose at the upland/wetland margin may increase the undesirable characteristics of the pond edge for goose habitation, as may sandy areas. Lawn margins in particular tend to attract geese and should be avoided and/or set back from the pond edge.
- D. A buffer of 25 feet is recommended, plus an additional 25 feet when wildlife habitat is of concern. Leaving trees undisturbed in the buffer zone will minimize the disruption to wildlife and reduce the chance for invasion of nuisance vegetation.
- E. Wetland plantings should provide a diversity of plant material. The diversity allows a safety margin should the finished hydrologic conditions not match the design to the degree intended. Also, the diversity allows accommodation of varying flows that occur throughout the year. Avoid monocultures that could lead to large areas of vegetation failure.
- F. Consider using "peat blocks" of wetland vegetation that provide both a seed bank and a mass of vegetative material with various rooted species. It is difficult to identify borrow sources for such blocks, particularly relative to the uncertain timing associated with construction projects, but where possible, peat blocks have been demonstrated to be an effective means of gaining quick growth and a diversity of plant material.
- G. Above ground berms or high marsh wedges should be placed at approximately 50 foot intervals, perpendicular to the direction of the flow to increase the dry weather flow path within the stormwater wetland.
- H. Before the outlet, a four- to six-foot deep micropool (having a capacity of at least 10 percent of the total treatment volume), should be included in the design to prevent the outlet from clogging. A reverse slope pipe or a hooded, broad crested weir is the recommended outlet control.
- I. The outlet weir should be designed with risers to allow the pond elevation to be adjusted to address changing conditions, both at start up, and as conditions evolve. This also allows draining for occasional pond maintenance should the drain pipe clog or otherwise cease to function.
- J. To facilitate access for maintenance, the riser should be installed within the embankment.
- K. Install a bottom drain pipe with an inverted elbow to prevent sediment clogging in order to completely drain the stormwater wetland for emergency purposes or routine maintenance.
- L. Fit both the outlet pipe and the bottom drain pipe with adjustable valves at the outlet ends to regulate flows.

- M. Surround all deep-water cells with a safety bench having a minimum width of 10 feet and a depth of zero to 18 inches below pool's normal water level.
- N. Remember that a wetland treatment system's effectiveness in removing urban pollutants depends on the system's physical characteristics, such as wetland-to-watershed size ratio, runoff residence time in the wetland, and water budget.
- O. In general, as the wetland-to-watershed area ratio increases, the average runoff residence time increases and the effectiveness of the wetland for pollutant removal also increases.
- P. Prepare a water budget to demonstrate that the water supply to the stormwater wetland is greater than the expected loss rate.
- Q. Deeper, interconnected pools that do not dry out or freeze completely could be incorporated to allow movement of fish to eat mosquito larvae.
- R. Minimize large canopy trees or wooded areas that created shaded areas of wetlands that are ideal for mosquito breeding. Maximize open area as much as possible as wind and wave movement across open stretches of water discourages mosquito breeding.
- S. Consider public use of the wetland and how it will be managed. Evaluate whether the use will encourage contact of the water by the public or pets. Determine whether fencing or warning signage is appropriate to address human/pet contact issues, as well as thin ice. Avoid fencing that restricts wildlife movement and reduces the habitat value of the wetland. It may be appropriate to provide interpretive material that explains that a "constructed wetland" is part of the utility infrastructure and helps to clean water and absorb flood flows.

Wetland Size:

A wetland surface area of one to two percent of the watershed area is recommended, depending on the nature of the watershed and the design of the facility.

During dry weather, flow must be adequate to provide a baseflow and to maintain the vegetation. The flow path should be maximized to increase the runoff's contact time with plants and sediments.

Outlet Design:

- A. An orifice or other outlet structure can be used to restrict the discharge to the required flow. Because of the abundance of vegetation in the wetland, a trash guard should be used to protect the outlet.
- B. A trash guard large enough to keep velocities at two fps or less will reduce clogging problems.
- C. Flow from the wetland should be conveyed through an outlet structure that is located within the deeper areas of the wetland. Discharging from the deeper areas using a reverse slope pipe prevents the outlet from becoming clogged. A micropool just prior to the outlet will also prevent outlet clogging. The outlet from the micropool should be located at least one foot below the normal pool surface.
- D. The micropool should contain approximately 10 percent of the treatment volume and be four to six feet deep.
- E. An adjustable gate-controlled drain capable of dewatering the wetland within 24 hours should be located within the micropool.
- F. A typical drain may be constructed with an upward-facing inverted elbow. The dewatering feature

eases planting and follow-up maintenance.

Wetland Vegetation:

Vegetation can be established by four methods: allowing volunteer vegetation to become established (not recommended), planting nursery vegetation, peat blocks, and seeding. A higher diversity wetland can be established when nursery plants or peat blocks are used. Because of Anchorage’s relatively mild summers, planting can take place through September. Planting can also take place during dormancy but contractors should be required to provide a guarantee for survival through the winter with growth in the spring. Peat blocks are typically installed in the winter such that large 6-foot x 6-foot blocks of earth and rooted matter can be placed on the substrate in solid form.

Select species adaptable to the broadest ranges of depth, frequency and duration of inundation (hydroperiod) or match plants to the inundation depths in wetlands with significant shelves and micro-grading. Match site conditions to the environmental requirements of plant selections. Take into account hydroperiod and light conditions. Recognize that actual conditions may vary from expected design conditions, and use a diversity of plants in the same planted water regimes to maximize success. Give priority to species that have already been used successfully in constructed wetlands and are commercially available. Allowing species transmitted by wind and water fowl to voluntarily become established in the wetland is unpredictable.

Wetlands established with volunteer species (requiring seed distribution via stream flows and air- or bird-deposited seed) can result in low plant diversity with monotypic stands of exotic or invasive species. Wetland areas that rely on volunteer growth tend to allow interim pedestrian or pet traffic that kills incoming vegetation and can eliminate the possibility of volunteer growth. This can also increase the incidence of goose habitation. Additional guidance with selecting non-invasive plant species appropriate for constructed wetlands is presented in Appendix E. Avoid using “volunteer growth” as a method of revegetation.

Many wetland species require specific planting approaches depending on the location and method. Consult *A Revegetation Manual for Alaska* by the Alaska Department of Natural Resources Alaska Plant Materials Center as well as *Streambank Revegetation and Protection, a Guide for Alaska*, by State of Alaska ADF&G for more information. In particular, willows are a valuable revegetation material and require specific considerations in harvesting and planting.

The use of peat blocks allows installation of rooted matter that has a diversity of species and a seed bank of dormant material. This material can come alive under appropriate conditions, producing rapid growth. The rooted substrate provides immediate benefit to water quality and habitat, though there is often an initial release of organics resulting from vibration and damage during harvesting and planting. Peat block revegetation requires identification of a donor site which can be difficult to schedule, though not impossible. Peat block construction also tends to be expensive relative to other methods, though wetland mitigation requirements may sometimes result in the availability of donor sites at a reasonable price.

Peat blocks construction requires cutting back the above-ground vegetative material, freezing to 18”-24” depth, with harvest, and placement in winter conditions. Items such as keeping “green side up” become important as does setting the blocks at the new site at an appropriate elevation.

Construction and Sequencing:

A. Sites must be carefully evaluated when planning stormwater wetlands. Soils, depth to bedrock, and

- depth to water table must be investigated before designing and siting stormwater wetlands.
- B. A "pondscaping plan" should be developed for each stormwater wetland. The plan should include hydrological calculations (or water budget), a wetland design and configuration, elevations and grades, a site/soil analysis, and estimated depth zones.
 - C. Plans must include consideration of depth of each bench and appropriate species. Substrate must be appropriate to encourage plant growth. Avoid loose, peat-rich substrate that might result in release of significant organics into the water stream.
 - D. The plan should also contain the location, quantity, and propagation methods for the stormwater wetland plants. Site preparation requirements, maintenance requirements, and a maintenance schedule are also necessary components of the plan. If harvesting plants to remove accumulated nutrients (after plants are mature) is planned, this component should be included in the maintenance plan.
 - E. The water budget should demonstrate that there will be a continuous supply of water to sustain the stormwater wetland. The water budget should be developed during site selection and checked after preliminary site design. Drying periods of longer than two months have been shown to adversely affect plant community richness, so the water balance should confirm that drying will not exceed two months. If a long-term continuous simulation analysis is not performed, one average rainfall year and one dry year (approximately 25th percentile) should be evaluated to ensure performance.
 - F. After excavation and grading, the wetland should be kept flooded until planted. The initial flooding helps provide a good bed for planting and flushes out loose material that may hinder plant growth.
 - G. After the facility is flooded and two weeks before planting, the wetland is typically drained and surveyed to ensure that depth zones are appropriate for plant growth. Revision may be necessary to account for any changes in depth.
 - H. Next, the site is staked to ensure that the planting crew spaces the plants within the correct planting zone.

Maintenance:

Stormwater wetlands require routine maintenance. The small forebay should be dredged every other year to protect the wetland from excessive sediment buildup. Careful observation of the system over time is required. Data gathered during these inspections should be recorded, mapped and assessed. Inspections should be conducted at least twice a year for the first three years and annually thereafter.

The following observations should be made during the inspections:

- A. Types and distribution of dominant wetland plants in the marsh;
- B. The presence and distribution of planted wetland species;
- C. The presence and distribution of invasive wetland species;
- D. Signs that invasive species are replacing the planted wetland species;
- E. Percentage of unvegetated standing water (excluding the deep water cells which are not suitable for emergent plant growth);
- F. The maximum elevation and the vegetative condition in this zone, if the design elevation of the normal pool is being maintained for wetlands with extended zones; and
- G. Stability of the original depth zones and the microtopographic features, accumulation of sediment in

the forebay and micropool, and survival rate of plants in the wetland buffer. Determine whether there has been short-circuiting that reduces retention time and creates “backwaters.”

Other important maintenance items include:

- A. Regulating the sediment input to the wetland is the priority maintenance activity.
- B. The majority of sediments should be trapped and removed before they reach the wetlands either in the forebay or in a pond component. Gradual sediment accumulation in the wetland results in reduced water depths and changes in the growing conditions for the emergent plants. Furthermore, sediment removal within the wetland can destroy the wetland plant community. Shallow marsh and extended detention wetland designs include forebays to trap sediment before reaching the wetland. These forebays should be cleaned out every other year.
- C. Pond/wetland system designs do not include forebays as the retention basin itself acts as an oversized forebay. Sediment cleanout of pond/wetland systems is needed every 10 years.
- D. The key to using the wetland effectively is that the ponds must function so as not to destroy the wetland vegetation. Slight modification of operations and plantings may be necessary as operations proceed.
- E. Harvesting of wetland vegetation can also be considered to remove nutrients from the wetland system and to minimize nutrient release when vegetation dies in the autumn. This is not generally recommended, but in special cases it will remove the nutrients contained in the vegetation from the system. If vegetation is to be harvested, design features should be included that will allow the wetland to be dewatered.
- F. Maintenance requirements for constructed wetlands are particularly high while vegetation is being established (usually the first three years). This is likely to include removal of invasive species and replanting natives.
- G. Additional routine maintenance tasks, which can be conducted on the same schedule, include removing accumulated trash from trash racks, outlet structures, and valves.

Table 6.6-15: Summary of Maintenance Activities for Constructed Wetlands

Activity	Frequency
Dredging of the forebay to protect from excess sediment buildup	Every two years
Routine inspections including data gathering	Once a year (Twice a year for first three years)
Sediment cleanout of pond/wetland systems	Every 10 years
Removal of accumulated trash and debris from trash racks, outlet structures, and valves	As needed

6.6.13 Landscaped Depressions

<p>Description</p> <p>A shallow depression in a site’s landscape designed to capture and store or infiltrate stormwater runoff from pervious areas.</p>																			
<p>Stormwater Management Suitability</p> <p>Runoff:</p> <table> <tr> <td>Rate Control:</td> <td>Moderate to High</td> <td rowspan="2">Suitable to meet or help meet requirements for:</td> </tr> <tr> <td>Volume Reduction:</td> <td>Moderate to High</td> </tr> </table> <p>Implementation Considerations:</p> <table> <tr> <td>Land Requirement:</td> <td>Moderate</td> <td>Water Quality Treatment through Green Infrastructure ✓</td> </tr> <tr> <td>Capital Cost:</td> <td>Low</td> <td>Detention ✓</td> </tr> <tr> <td>Accepts Hotspot Runoff:</td> <td>No¹</td> <td></td> </tr> <tr> <td>Maintenance:</td> <td>Low</td> <td></td> </tr> </table>			Rate Control:	Moderate to High	Suitable to meet or help meet requirements for:	Volume Reduction:	Moderate to High	Land Requirement:	Moderate	Water Quality Treatment through Green Infrastructure ✓	Capital Cost:	Low	Detention ✓	Accepts Hotspot Runoff:	No ¹		Maintenance:	Low	
Rate Control:	Moderate to High	Suitable to meet or help meet requirements for:																	
Volume Reduction:	Moderate to High																		
Land Requirement:	Moderate	Water Quality Treatment through Green Infrastructure ✓																	
Capital Cost:	Low	Detention ✓																	
Accepts Hotspot Runoff:	No ¹																		
Maintenance:	Low																		
<p>Key Considerations</p> <p>Advantages:</p> <ul style="list-style-type: none"> • Flexible and easy to construct • Utilizes natural green space • Can be used as a stormwater retrofit <p>Limitations:</p> <ul style="list-style-type: none"> • Not recommended for areas with steep slopes • May attract birds and breed mosquitos • Tends to consume space <p>Design:</p> <ul style="list-style-type: none"> • Best suited for small contributing drainage areas • Best applied to areas with relatively shallow slopes 																			

(1) Yes, if pretreatment is provided.

Description:

In general, landscaped depressions can be described as shallow depressions in a site’s landscaping that collect stormwater runoff. They are similar to bioretention areas, but are not designed with an underdrain. These depressions typically rely on infiltration and evaporation of runoff from small storm events, with an overflow provided for larger events.

Ideally, landscaped depressions are designed to accept inflow as sheet from adjacent surfaces.

Similar to bioretention areas, they are extremely versatile and can have varying geometric forms, making them adaptable to many types of site layouts. Engineers are encouraged to work with landscape architects to incorporate aesthetic contouring and shaping of the landscape into the design.

Advantages:

- A. Reduces the size and cost of downstream stormwater control facilities and/or storm drain systems by capturing and infiltrating stormwater on site.
- B. When properly designed and maintained, they are aesthetically pleasing due to the natural blending into the landscape.
- C. Reduces the volume of runoff from a drainage area.
- D. Flexible and adaptable to a variety of sites.
- E. Can be applied in many different climates and geologic environments.
- F. Reduces downstream flooding and protects stream bank integrity.
- G. Provides groundwater recharge and base flow in nearby streams.
- H. Reduces local flooding.
- I. Can be used as a stormwater retrofit, by modifying existing landscaped areas or green space

Figure 6.6-21: Landscaped Depressions**Limitations:**

- A. Usually not feasible for treating a large drainage area with a single facility. Multiple smaller facilities would be required.
- B. May require sediment removal over time.
- C. Tend to consume space.

Design:*Site Sensitivity Analysis:*

- A. Landscaped depressions should usually be used on small sites (i.e., one acre or less) or multiple facilities should be incorporated into the design. When a single landscaped depression is used to treat larger areas, it tends to clog or become very large.
- B. Landscaped depressions can be applied in almost any type of soil. Runoff naturally infiltrates

into the native soil below or is transpired through vegetation. For soils with slower infiltration rates, a larger area may be needed to ensure sufficient storage volume and drain-down time for the water quality design event.

- C. Landscaped depressions areas are best applied to areas with relatively shallow slopes (usually about five percent). It's also important to consider the slope of adjacent properties that are down gradient of the site to limit the possibility of seepage from the subgrade to the ground surface at lower elevations.
- D. See Section 6.2 and Table 6.4-1 for applicable setbacks and separation distances from groundwater, bedrock, or other limiting strata.

General Design Considerations:

Pretreatment-

As with any infiltration area, landscaped depressions can be susceptible to clogging from sediment. Sheet flow across a grass filter strip upstream of the landscaped depression helps limit the amount of sediment that enters the facility. Accumulated sediment can be removed from the depressions if needed.

Engineered Soil (also known as Growing Media)-

To encourage infiltration, landscaped depressions can include an engineered soil media, though this is not required. If native soils are used, the designer should ensure that the soil can support the selected vegetation. Additional information regarding Engineered Soil is presented in Appendix H.

Size and Depth -

The size of the landscaped depression is a function of runoff volume during the water quality design event. Landscaped depressions are typically not suitable for larger storm events. The depth of the depressed area should not typically exceed 12-18 inches. The facility should be designed to drain in approximately 48 hours of no precipitation. Side slopes should be gentle (minimum of 4:1 and usually much greater). The designer should consider the need for mowing or other types of vegetation maintenance when designing the landscaped depression.

Overflow structure-

In most cases, an overflow structure or separate conveyance system should be provided to convey flow from large storms (storms that are not treated by the landscaped depression) to a downstream facility or stormdrain system. Overflow structures can be berms, weirs, pipes, inlets, etc. In Figure 6.6-21 above, the overflow structure is simply the grade of the surrounding a landscape. When the depression become full, water overflows the depression along the length of one side, and flows downhill to a nearby stream. The designer should consider the potential for erosion in the design.

Vegetation-

Vegetation in landscaped depressions can vary with the preferred landscape design, but should be able to tolerate periods of inundation. Guidance with selecting non-invasive plant species appropriate for landscaped depressions is presented in Appendix E. Plants should be selected to

tolerate both wet and dry conditions; plants that require ongoing inundation should not be used.

Maintenance:

Landscaped depressions require seasonal landscaping maintenance. In many cases, maintenance is more involved initially until plants are established, but less maintenance is required in the long term. Designers should ensure that the area is easily accessible for maintenance. The table below lists the typical maintenance activities for bioretention areas.

Table 6.6-16: Summary of Maintenance Activities for Landscaped Depressions

Activity	Frequency
Water plants regularly	As needed during first growing season
Water during dry periods	As needed after first growing season
Inspect soil and repair eroded areas	Monthly or following significant rainfall events
Remove litter, debris, and sediment	As needed
Maintain vegetation (pruning, mowing, tilling, weeding, re-amendment of soil)	As needed

6.6.14 Canopy Cover and Natural Vegetation Retention

<p><u>Description</u></p> <p>Maintaining trees and naturally vegetated areas during site development and construction, and utilizing these areas for stormwater and landscape benefits.</p>															
<p><u>Stormwater Management Suitability</u></p> <p><i>Runoff:</i></p> <table> <tr> <td>Rate Control:</td> <td>Low</td> <td rowspan="2"> <p><i>Suitable to meet or help meet requirements for:</i></p> <p>Water Quality Treatment through Green Infrastructure ✓</p> </td> </tr> <tr> <td>Volume Reduction:</td> <td>Moderate</td> </tr> </table> <p><i>Implementation Considerations:</i></p> <table> <tr> <td>Land Requirement:</td> <td>Moderate</td> </tr> <tr> <td>Capital Cost:</td> <td>Low</td> </tr> <tr> <td>Accepts Hotspot Runoff:</td> <td>No¹</td> </tr> <tr> <td>Maintenance:</td> <td>Low</td> </tr> </table>			Rate Control:	Low	<p><i>Suitable to meet or help meet requirements for:</i></p> <p>Water Quality Treatment through Green Infrastructure ✓</p>	Volume Reduction:	Moderate	Land Requirement:	Moderate	Capital Cost:	Low	Accepts Hotspot Runoff:	No ¹	Maintenance:	Low
Rate Control:	Low	<p><i>Suitable to meet or help meet requirements for:</i></p> <p>Water Quality Treatment through Green Infrastructure ✓</p>													
Volume Reduction:	Moderate														
Land Requirement:	Moderate														
Capital Cost:	Low														
Accepts Hotspot Runoff:	No ¹														
Maintenance:	Low														
<p><u>Key Considerations</u></p> <p><i>Advantages:</i></p> <ul style="list-style-type: none"> • Does not require construction • Utilizes natural green space • Low Cost • Promotes natural habitat and improves air quality <p><i>Limitations:</i></p> <ul style="list-style-type: none"> • Requires strategic construction staging • Consumes space on site <p><i>Design:</i></p> <ul style="list-style-type: none"> • Varies with the type of vegetation 															

(1) Yes, if pretreatment is provided.

Description:

Natural vegetation provides a host of watershed benefits. Stormwater is captured in the canopy of trees, infiltrated around the roots of vegetation, and returned to the atmosphere through the vegetation's evapotranspiration processes. Maintaining natural vegetation when a site is developed can decrease the need for/size of stormwater management and treatment facilities, reduce the need for constructed landscaping, and improve the air quality. Natural vegetation can reduce runoff from the areas they occupy, and can also accept water from adjacent impervious areas. Ideally, runoff from adjacent surfaces should be designed to sheet flow to naturally vegetated areas.

Advantages:

- A. Does not require construction
- B. Reduces the size and cost of other stormwater control facilities and/or storm drain systems by capturing and infiltrating stormwater on site
- C. Reduces the volume of runoff from a drainage area
- D. Aesthetically pleasing
- E. Low cost
- F. Reduces downstream flooding and protects stream bank integrity
- G. Provides groundwater recharge and base flow in nearby streams
- H. Reduces local flooding
- I. Promotes natural habitat and improves air and soil quality
- J. Reduces, temporarily detains, and/or removes pollutants from runoff

Limitations:

- A. Usually not feasible for treating a large drainage area with a single vegetated area.
- B. Requires strategic construction staging
- C. Tends to consume space
- D. Only applicable to sites that have natural vegetation present prior to development

Design:*Site Sensitivity Analysis:*

- A. Canopy cover and natural vegetation retention can provide stormwater benefits in nearly all soil types.
- B. If water from adjacent surfaces is directed to naturally vegetated areas, performance is enhanced on shallower slopes (generally less than six percent).
- C. See Section 6.2 and Table 6.4-1 for applicable setbacks and separation distances.

Stormwater capture using given treatment capacity-

As a stand-alone site benefit, canopy cover and naturally vegetated areas are assumed to be able to treat up to one inch of rainfall that falls onto the vegetated area through capture, infiltration, evaporation, and transpiration. (See Section 4, Table 4.4-5). This means that canopy cover and naturally vegetated areas would not contribute runoff for the water quality treatment event (Stormwater Management Requirement 1.) Additionally, canopy cover and naturally vegetated areas can be designed to accept stormwater runoff from adjacent impervious surfaces for stormwater treatment. These areas essentially act as naturally-occurring bioretention areas. (Note that appropriate peak flow and flood conveyance design is still required.)

The quantity of runoff that an area can accept depends on the infiltration rate of the native soil. If no infiltration testing is performed, the treatment design is limited to a total of one inch of runoff over the canopy cover or naturally vegetated area.

Example: A one-acre site is being developed. It is currently 100% naturally vegetated. The proposed design turns half of the site (0.5 acres) into roof tops and parking lots. Half of the site remains naturally

vegetated. The entire site has a slope of approximately 1%. Stormwater Management Requirement 1 requires treatment of runoff generated from the first 0.52 inches of rain. What portion of the site will generate runoff that requires constructed treatment facilities and how much can be directed to the natural vegetation?

Solution: The vegetated area is able to accept a total of one inch of runoff. For Requirement 1, 0.52 inches falls across the entire site. Water that falls onto the naturally vegetated area does not require treatment. Additionally, this area can accept an additional 0.48 inches.

Capacity of Vegetated area =

$$(0.5 \text{ acres} * 0.48 \text{ inches} * 1 \text{ foot}/12\text{inches} * 43560 \text{ square feet}/1 \text{ acre}) = 871.2 \text{ cubic feet.}$$

The volume of water that requires treatment from the rest of the site is computed using the direct determination method from Section 4:

$$\text{Runoff} = \text{Rainfall} - \text{Depression Storage} - \text{Infiltration loss.}$$

Rainfall = 0.52 inches

Depression storage for impervious surfaces at 1% from Table 4.4-5 = 0.1 inches

Infiltration on impervious surfaces = 0.

$$\text{Runoff} = 0.52 - 0.1 - 0 = 0.42 \text{ inches.}$$

Runoff volume from Impervious Area =

$$0.5 \text{ acre} * 0.42 \text{ inches} * 1 \text{ foot}/12\text{inches} * 43560 \text{ square feet}/1 \text{ acre}) = 762.3 \text{ cubic feet.}$$

$$\text{Capacity of the naturally vegetated area} - \text{Runoff from Impervious Area} = 108.9 \text{ cubic feet.}$$

So, the naturally vegetated area has more than enough capacity for water quality treatment of the site, provided the distribution guidelines in this section are met.

Stormwater capture using additional infiltration capacity-

In some cases, naturally vegetated areas may be able to handle more than one inch of water if they have a high infiltration rate. If the designer wishes to utilize a vegetated area for treatment based on actual infiltration rates, instead of the given one inch, the area should be designed similarly to a constructed bioretention facility, and the following steps are required. Reference the Bioretention section of this manual for additional sizing guidelines.

- A. Provide infiltration testing to ensure that the vegetated area is adequate for the additional design inflow.
- B. Ensure that the area has appropriate overflow for storm events exceeding the design event.
- C. Consider the topography of the area and ensure that overflow water is safely directed to an appropriate receiving system and does not adversely impact adjacent properties or other parts of the site.

Inflow from Adjacent Surfaces (if used for treating water from adjacent surfaces)

Water from adjacent areas should be designed to enter vegetated areas as sheet flow as much as possible. If concentrated flow entry is required, care should be taken to ensure that the water spreads out over the site as much as possible. This can be achieved through level spreaders, gentle swales, or natural topography.

Pretreatment (if used for treating water from adjacent surfaces)-

As with any area that is used to infiltrate water from impervious surfaces, naturally vegetated areas can clog with sediment if some type of pre-treatment or preventative maintenance is not incorporated into the site design. Sheet flow across a grass filter strip upstream of the area helps limit the amount of sediment that enters the facility. Accumulated sediment can be removed from the vegetated areas as needed.

Size and Depth

The size of a canopy cover or naturally vegetated area will depend on the availability of these areas on the site and the locations of these areas relative to the rest of the site design. If naturally vegetated areas are not plentiful on the site and the designer wishes to direct runoff from impervious surfaces to the naturally vegetated area, it is often beneficial to first determine how much water the area can accept (based on size and infiltration rates) and then design the contributing area accordingly.

Overflow structure (if used for treating water from adjacent surfaces)

In most cases, an overflow structure or separate conveyance system should be provided to convey flow from large storms (storms that are not treated by the landscaped depression) to a downstream facility or storm drain system. Overflow structures can be swales, inlets, or weirs located down-gradient from the vegetated area. Refer to the overflow discussions in the Bioretention and Landscaped Depression sections for more information.

Vegetation

The types of vegetation that qualify as providing a canopy or being naturally vegetated are combinations of vegetation providing full cover or canopy over the associated surface area.

Landscaping

In many cases, preservation of naturally vegetated areas can eliminate or reduce the need for constructed landscaping. Some limitations regarding types of vegetation may apply. If you have questions or would like to discuss using natural vegetation for landscaping credit, please contact MOA Watershed Management Services.

Maintenance:

When incorporated into a site design, canopy cover and naturally vegetated areas require seasonal landscaping maintenance to maintain their stormwater benefit. The table below lists the typical maintenance activities for these areas.

Table 6.6-17: Summary of Maintenance for Canopy & Naturally Vegetated Areas

Activity	Frequency
Water during dry periods	As needed
Inspect soil and repair eroded areas	As needed
Remove litter and debris	As needed
Remove sand build up from adjacent surface inflow	As needed
Protect vegetation from damage or removal other than as-needed to prune or remove hazardous branches or trees	As needed for the life of the facility

6.6.15 Catch Basins for Sediment Capture Treatment

<p>Description</p> <p>In some cases, traditional catch basins can be configured to be a valuable step in a stormwater treatment train by providing sediment capture from runoff from impervious surfaces.</p>																									
<p>Stormwater Management Suitability</p> <table border="0"> <tr> <td colspan="2">Runoff:</td> <td rowspan="2">Suitable to meet or help meet requirements for:</td> </tr> <tr> <td>Rate Control:</td> <td>Low</td> </tr> <tr> <td>Volume Reduction:</td> <td>Low</td> <td>Pre-treatment ✓</td> </tr> <tr> <td colspan="2">Implementation Considerations:</td> <td>Part of Traditional Water Quality Treatment ✓</td> </tr> <tr> <td>Land Requirement:</td> <td>Low</td> <td></td> </tr> <tr> <td>Capital Cost:</td> <td>Low</td> <td></td> </tr> <tr> <td>Accepts Hotspot Runoff:</td> <td>Yes</td> <td></td> </tr> <tr> <td>Maintenance:</td> <td>High</td> <td></td> </tr> </table>			Runoff:		Suitable to meet or help meet requirements for:	Rate Control:	Low	Volume Reduction:	Low	Pre-treatment ✓	Implementation Considerations:		Part of Traditional Water Quality Treatment ✓	Land Requirement:	Low		Capital Cost:	Low		Accepts Hotspot Runoff:	Yes		Maintenance:	High	
Runoff:		Suitable to meet or help meet requirements for:																							
Rate Control:	Low																								
Volume Reduction:	Low	Pre-treatment ✓																							
Implementation Considerations:		Part of Traditional Water Quality Treatment ✓																							
Land Requirement:	Low																								
Capital Cost:	Low																								
Accepts Hotspot Runoff:	Yes																								
Maintenance:	High																								
<p>Key Considerations</p> <p>Advantages:</p> <ul style="list-style-type: none"> • Easily accessed for maintenance • Often necessary for roadway drainage anyway • Standardized designs allow for relatively easy installation <p>Limitations:</p> <ul style="list-style-type: none"> • No volume control • Not a stand-alone treatment method <p>Design:</p> <ul style="list-style-type: none"> • Special configuration is required to meet treatment requirements. 																									

General Description:

Catch basins are the primary inlet structures for drainage systems. They serve as an entry point where surface drainage in ditches, gutter, swales and natural surface runoff is transitioned into a piped drainage network.

When configured properly, catch basins can serve as an initial sediment capture device in a storm drain network. The basins are fitted with a sump area below the elevation of the outlet pipe invert where settlement takes place and sediments are stored between maintenance cleanings.

Design:

The following criteria apply to catch basins if they are used for treatment purposes. These criteria are in addition to the catch basin criteria presented in Section 5.

- A. Gutter flow shall not exceed a distance of 400 feet without reaching a catch basin or curb cut leading to a stormwater facility. Note that sediment storage adequacy is built in this spacing.
- B. No storm drain pipes, with the exception of field inlets and underdrains shall be connected to a catch basin structure. All catch basins will be designed off-line from the main storm drain system. This ensures that accumulated sediments are not scoured from sumps by high velocity piped flows.
- C. Catch basin manholes should be avoided in system layout or used only when alternatives are severely limited.
- D. In unpaved areas, the placement of filter rock, asphalt, or concrete aprons that slope toward the inlet are required. The apron shall extend at least 2.5 feet from the outside edge of the inlet.
- E. The gutter flow velocity on street grades over 5 percent shall not exceed 2 feet per second. By keeping gutter velocities low, less sediment and pollutants will be transported into the storm drain system.
- F. Catch basin leads shall have a minimum flow velocity of 3.0 feet per second at the design flow.

Additional Criteria for Non-Transportation Projects:

Catch basins that receive flows from large or unusually dirty areas may require additional sediment transport and storage analysis. In addition to the criteria mentioned above, designs must ensure that the following additional criteria are met:

- A. Sediment loading is based on average annual accumulation on the impervious surfaces of the contributing area. Standard values for Anchorage are presented in the table below.

Table 6.6-18: Average Annual Sediment Loading

Impervious Area Type	Average Sediment Loading
Parking Areas	1500 (lbs per acre)
Primary Roads	2000 (lbs per curb mile)
Secondary Roads	1000 (lbs per curb mile)

- B. Annual sediment loading is calculated as follows:
- C. Compute the total curb miles per road type and/or the parking lot acreage contributing to each catch basin.
- D. Multiply the curb miles and/or parking lot areas by the average sediment loads in Table 6.6-18 to define the sediment loading. This value is the annual washed off sediment load in pounds.
- E. The 2 year accumulation of sediments in individual catch basins shall not exceed the volumetric

storage capacity of the catch basin, defined as the sump area below 10 inches of the outlet invert.

- F. To determine the 2-year volume of captured sediment, convert the weight of the annual washed off sediment to volume using 90 lbs/ft³ density. Multiply the annual volume by 2 to represent the 2-year volume.
- G. Ensure that the number and spacing of catch basins is adequate to meet the volume requirement.

Maintenance:

Catch basins installed on private property shall be maintained by the property owners.

Table 6.6-19 Summary of Maintenance Activities for Catch Basins

Activity	Frequency*
Clean out sediment	A minimum of once every two years. More frequent cleaning may be required for facilities accepting hotspot runoff or as required by relevant permits.
Inspect for sediment accumulation level, damage, including reduced capacity, corrosion, and settling	Once a year

**Alternate maintenance schedules may be submitted for approval for projects within municipal ROW. Coordinate with Street Maintenance and PM&E.*

6.6.16 Sedimentation Basins

<p><u>Description</u></p> <p>A basin formed by excavation or by constructing an embankment so that sediment-laden runoff is detained, allowing sediment to settle out before the runoff is discharged.</p>																									
<p><u>Stormwater Management Suitability</u></p> <table> <tr> <td colspan="2">Runoff:</td> <td rowspan="2">Suitable to meet or help meet requirements for:</td> </tr> <tr> <td>Rate Control:</td> <td>High</td> </tr> <tr> <td>Volume Reduction:</td> <td>Low</td> <td>Detention ✓</td> </tr> <tr> <td colspan="2">Implementation Considerations:</td> <td>Pre-treatment ✓</td> </tr> <tr> <td>Land Requirement:</td> <td>High</td> <td>Water Quality Treatment through Green Infrastructure ✓</td> </tr> <tr> <td>Capital Cost:</td> <td>Moderate¹</td> <td></td> </tr> <tr> <td>Accepts Hotspot Runoff:</td> <td>No²</td> <td></td> </tr> <tr> <td>Maintenance:</td> <td>Moderate</td> <td></td> </tr> </table>			Runoff:		Suitable to meet or help meet requirements for:	Rate Control:	High	Volume Reduction:	Low	Detention ✓	Implementation Considerations:		Pre-treatment ✓	Land Requirement:	High	Water Quality Treatment through Green Infrastructure ✓	Capital Cost:	Moderate ¹		Accepts Hotspot Runoff:	No ²		Maintenance:	Moderate	
Runoff:		Suitable to meet or help meet requirements for:																							
Rate Control:	High																								
Volume Reduction:	Low	Detention ✓																							
Implementation Considerations:		Pre-treatment ✓																							
Land Requirement:	High	Water Quality Treatment through Green Infrastructure ✓																							
Capital Cost:	Moderate ¹																								
Accepts Hotspot Runoff:	No ²																								
Maintenance:	Moderate																								
<p><u>Key Considerations</u></p> <p>Advantages:</p> <ul style="list-style-type: none"> • Can be very effective in treating sediment-laden runoff • Relatively easy to construct <p>Limitations:</p> <ul style="list-style-type: none"> • Generally requires a good deal of site area • Must be properly maintained to insure proper operation <p>Design:</p> <ul style="list-style-type: none"> • Access for sediment removal and maintenance • Additional volume for sediment storage • Basin treatment areas may include a main treatment area, inlet/outlet structures, emergency overflows and access points 																									

(1) Not considering land acquisition

(2) Yes, if pretreatment is provided.

General Description:

A sedimentation basin detains stormwater in an impoundment and slowly releases it downstream. Settlement effectiveness is a function of the settlement time, the settling velocity of the particles and the

efficiency of the basin. This type of facility traps sediment and helps prevent undesirable deposition in downstream waterways. A conceptual layout is shown in Figure 6.6-22.

Figure 6.6-22: Sedimentation Basin Conceptual Layout

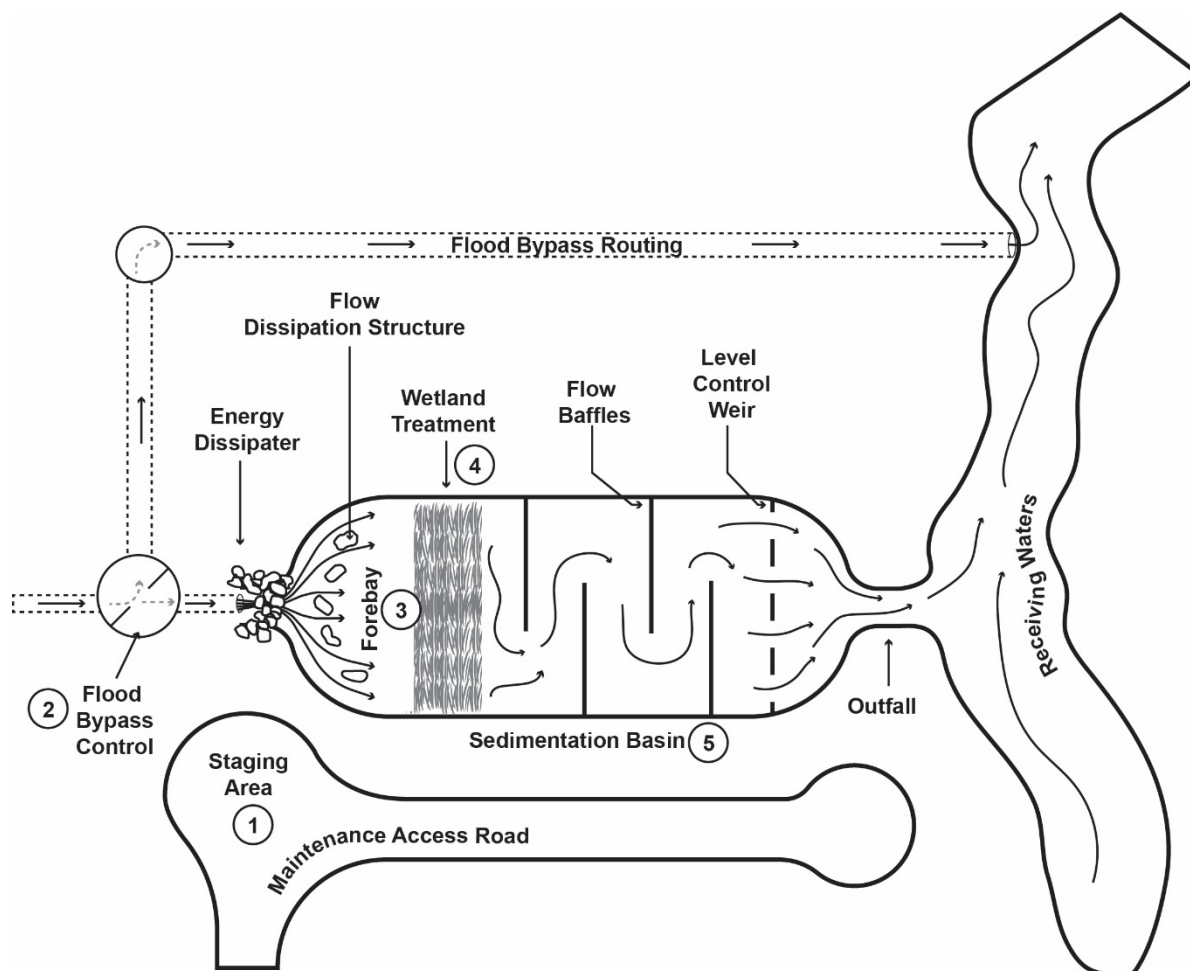

Advantages:

- A. Can provide some of the most effective storm water treatment if designed properly.
- B. Can be designed to treat runoff from large areas and are recommended as regional controls.
- C. Help to control overall stormwater runoff for small storms thus protecting streams and rivers off site.
- D. Relatively easy to construct.
- E. Can be effective where ground water tables are high and/or native soils have low or minimal infiltrative capacity.

Limitations:

- A. Sediment basins are relatively large, generally requiring a good deal of site area.
- B. It can be difficult to maintain a sedimentation basin during the construction phase.
- C. Improper construction and maintenance greatly reduces their effectiveness.

- D. Not effective for removing colloidal sediments and must have flood bypass structures to avoid re-suspension of captured sediments during high flow events.
- E. Less cost effective when used with small contributing areas.

Applicability:

Sedimentation basins are recommended in the following circumstances:

- A. Where LID surface and subsurface treatment structures are not feasible.
- B. In large drainage systems where LID features or an OGS structures cannot accommodate annual captured sediment loads.
- C. Where small particle sediment loading is a known issue in the drainage basin.
- D. In conjunction with other storm water treatment devices when discharging to ecologically sensitive areas.

Design Requirements:

Sedimentation basins should consider all general design principles including: land acquisition costs, adherence to MOA Context Sensitive Solutions / Context Sensitive Design standards, multiuse facility for recreation and biological habitat, and the hydrologic, soils and groundwater characteristics of the site.

Treatment performance of sedimentation basins is based on dimensions, hydraulic characteristics, and biological processes. The purpose and design descriptions of the critical elements are as follows:

Maintenance Access/Staging Area

- A. A maintenance access/staging area is required for inspection, sediment removal, and other operational activities. The dimensions of the maintenance area should be based on the turning radii, performance capabilities, and requirements of maintenance equipment and personnel.
- B. Provide for a sediment removal access and provide an operations and maintenance manual that includes basin design calculations and sediment removal frequency.

Design Flow and Flood Bypass Structure

The sedimentation basin design flow is the peak flow from the 1-year, 24-hour event as defined in Section 4 of this manual. A flood bypass structure for events higher than the design event is required. This ensures that larger flows are diverted past the sedimentation basin to prevent scour of previously captured sediment and constructed wetlands features. Pipes, manholes, channels, metering weirs, or other structures may be appropriate to divert flows around the sedimentation basin. These conditions can severely limit infiltration based storm water solutions.

Pretreatment (Optional)

- A. Pretreatments primarily function is coarse sediment removal before the sedimentation basin. Pretreatment can be in the form of an OGS, a forebay pond, or a comparable structure which captures sediment 250 microns or greater. A forebay may also function as a hydraulic control to disperse flows at the entrance to the main settlement basin. This dispersion function will increase treatment performance.
- B. Pretreatment is highly recommended for drainage systems with large wash off loads from street

sediments or geomorphologic conditions.

- C. Ensure maintenance access for sediment removal from any pretreatment structure.

Wetlands Treatment (Optional)

- A. Constructed or natural wetlands are another recommended treatment process. The low velocity and shallow depth of wetlands increase particle settlement, and bring storm water into close contact with aquatic plants that can absorb pollutants and heavy metals.
- B. The wetlands can be located at any point after the inlet forebay but are most common after the initial settlement pond.
- C. To optimize performance, discharge through wetlands should be hydraulically controlled to distributed flow over the entire width. The design should evaluate scour and mitigate the possibility of short circuiting (channelization) within the wetlands. Additional attention should be given to winter condition impacts when ice cover can prevent normal flow distribution and creates scour channels. Channelization will reduce the treatment area, and can potentially reduce performance below that of a non-vegetated settling pond of similar size.
- D. Ensure that the wetlands design considers substrate stability, appropriate, vegetation types for targeted pollutants, and scour mitigation.

Sedimentation Basin

- A. The criteria presented in this section are based on a annual sediment capture rate $\geq 90\%$ for the 1-year 24 hour event, and a sediment storage volume \geq five times the calculated annual capture rate.
- B. The performance and design criteria for sedimentation basins primarily are based on the basin size and geometry. Determining the performance for a given basin is an iterative process where dimensions and geometry are modified to achieve optimum performance from the available land area.

The following steps outline the design process and the calculated performance. These calculations and the accompanying nomographs were based in part on: EPA manual EPA440/5-87-001, Methodology for Analysis of Detention Basins for Control of Urban Runoff Quality, Sept 1986

1. Calculate the peak flow (Q_T) and the storm runoff volume (V_T) from the contributing basin for the 1-year 24 hour event following the procedure from Section 4. If a forebay is included, modify the peak flow to account for the attenuation.

$$Q_T = 1 \text{ year, 24 hour Peak Flow, cfs}$$

$$V_T = 1 \text{ year, 24 hour storm runoff volume, cf}$$

2. Calculate a theoretical annual sediment capture volume using the following procedure:
 - a. For the drainage basin, calculate total curb miles per road type and parking lot acreage based on projected full build out.
 - b. Multiply the curb miles and parking lot areas by the average sediment loads in Table 6.6-18 to define the sediment loading.

- c. If catch basins are used for treatment in the contributing basin (see requirements of section 6.6-15), multiply the sediment load by 42% to determine the amount of sediment washed off annually and not captured by catch basins. This will be known as the annual washed off sediment load. If catch basins are not used for treatment in the upstream basin, skip this step.
 - d. If OGS systems are used for sediment capture in the upstream basin, account for removal of that sediment based on the manufacturer's published device efficiency or an average efficiency of 30% if the published data is not available. (For computing incoming sediment loading to OGS devices, see Section 6.6-17.) Ignore simple vaults, oil skimmers, non-functioning and unmaintained devices.
 - e. Assume that the sedimentation basin will capture 80% of the incoming sediment load. Multiply the sediment basin load by 0.8 to get the assumed annual sediment weight. Convert this annual weight into an annual volume using a density of 90 lbs/ft³.
3. Using this peak flow, Q_T , size the sed. basin surface area, A_B , to produce a hydraulic loading rate of 0.0005 fps. (Hydraulic loading rate = Incoming flow rate in cfs/area of the basin in sf.)

$$HLR = \frac{Q_T}{A_B} = \text{hydraulic loading rate, fps}$$

4. Calculate the basin flow path length and width given the sed. basin surface area, and the available land. The length to width ratio should be a minimum of 4L:1W.
5. Select a geometric efficiency value (N) based on layout and configuration of the basin. N values are larger for basins with more uniform dispersed flow and minimal short-circuiting. This value is used later to estimate the basin's treatment performance.

N = Basin Short circuiting adjustment factor

Figure 6.6-23: N Factor and Basin Geometry

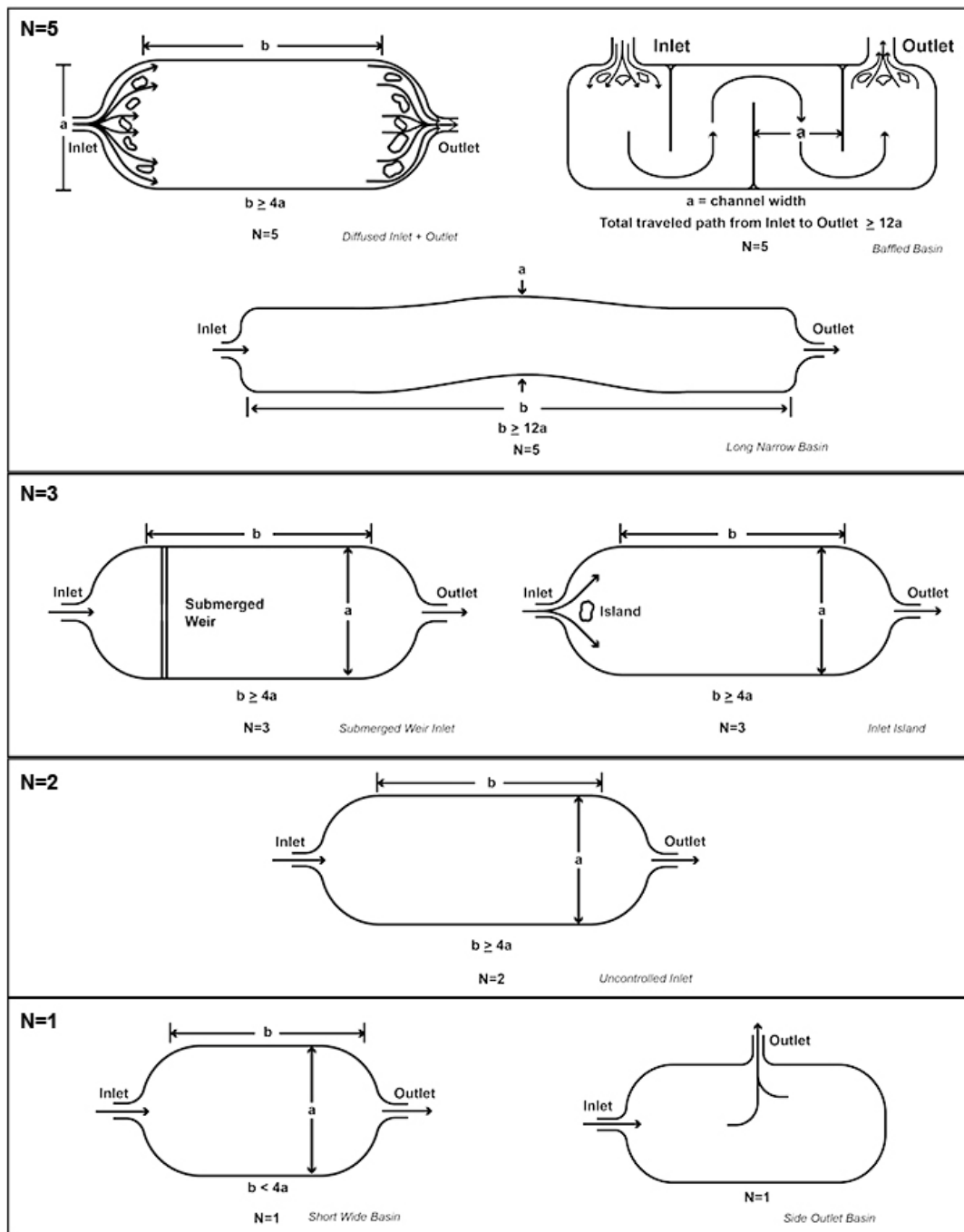

6. Size the sed. basin depth so that the sed. basin volume, V_B , is roughly twice the storm runoff volume (V_T calculated in step 1) plus five times the assumed annual sediment capture volume.
 - The basin depth (including the captured sediment volume) should no exceed 10 feet or be less than 5 feet above the sediment storage area. This depth allows for flows under winter ice cover.
7. Design the geometry and control structures for flood bypass.

8. Design any intake and outflow control or flow dispersion structures.
9. Analyze the water surface elevation during the 1-year 24 hour event, assume that sediment storage capacity is full. Assess impacts to adjacent property and modify as required.
10. Calculate the sed. basin surface area (A_B) and sed. basin volume (V_B) during the 1-year 24 hour storm event. This calculation also assumes sediment storage capacity is full.

A_B = Sed. Basin water surface area during the design event, (square feet)

V_B = Sed. Basin volume during design event, (cubic feet)

11. Determine the basin theoretical performance. Overall settling performance is a function of both quiescent settling between storm events and dynamic settling when water is moving through the basin during precipitation events. Calculations of these two performances require the use of several parameters that are based on local weather statistics and typical storm water sediment compositions. These parameters based on specific anchorage conditions are given in Tables 6.6-20 and 6.6-21.

Table 6.6-20 Standard Storm Statistical Values for Sedimentation Basin Calculations

Parameter	Symbol	Value for the Anchorage Bowl
Coefficient of Variation, intensity	COV_Q	0.676
Coefficient of Variation, runoff	COV_R	1.317
Reciprocal square of COV_Q	r	2.188
Average time between storm events in hrs,	Δm	91

Table 6.6-21 Particle Size Distribution of Stormwater Entering a Sed. Basin

Particle Size, μ	Percent Passing	Percent of Total Sediment	V_{si} (ft/sec)
>105	Particles larger than 105 μ are considered captured in catch basins, OGS or other storm drain structures. This component is ignored in calculations		
105	98 %	3 %	0.022
75	92 %	8 %	0.011
35.2	77 %	21 %	0.002
22.4	71 %	8 %	0.001
13.1	54 %	24 %	0.0003
6.6	44 %	14 %	0.00008
3.2	39 %	7 %	0.00002
1.3	28 %	15 %	0.000003
pan	Particles smaller than 10 micron are considered colloidal, non settleable, and are ignored in the calculations and subsequent removal efficiencies.		

Calculation of Dynamic Settling

12. Calculate the dynamic removal efficiency, R_{mdi} , for each particle size.

$$R_{mdi} = 1 - \left[1 + \frac{V_{si}}{N(HLR)} \right]^{-N}$$

R_{mdi} = dynamic removal efficiency for particle size "i", (%)

$$HLR = \frac{Q_T}{A_B} = \text{hydraulic loading rate, (fps)}$$

V_{si} = Settling velocity of particle size "i", (fps), (from Table 6.6.21)

N = Short circuit adjustment factor (unitless), (calculated in step 5)

13. Calculate the maximum removal efficiency for each particle size using the following equation:

$$Z_i = 1 - e^{-\left(\frac{V_{si}}{HLR}\right)} = \text{maximum removal efficiency for particle size "i", \%}$$

14. Calculate the long term dynamic removal efficiency for each particle size using the following equations:

$$R_{ldi} = Z_i \left[\frac{r}{r - \ln\left(\frac{R_{mdi}}{Z_i}\right)} \right]^{(r+1)}$$

R_{ldi} = long term dynamic removal efficiency for particle size "i", (%)

r = reciprocal square of coefficient of variation (unitless), (from Table 6.6.20)

The long term dynamic removal efficiency for each particle size denotes the percent of particles that settle through dynamic conditions on an annual basis.

15. Calculate the weighted average of the long term dynamic removal efficiency of all the particles sizes in Table 6.6-21. Particle sizes above 149 μ and below 1.3 μ can be ignored. The former are too coarse to be transported through the storm drain system in large numbers and the latter are colloidal and cannot be settled without coagulants.

$R_{ld \text{ average}}$ = *weighted long term dynamic removal efficiency*

$$R_{ld \text{ average}} = \sum_{i=1}^n R_{ldi} * \text{percentage of particle in PSD (See Table 6.6-21)}$$

16. Determine the fraction of particles not removed by dynamic settling using the following equation. This fraction will be used to determine the basin overall performance in the final steps.

$$f_D = 1 - R_{ld \text{ average}}$$

f_D = fraction of particles not removed through dynamic settling

Calculation of Quiescent Settling

Several performance ratios are calculated and then used with nomographs to determine quiescent treatment performance.

17. First, Calculate the sed. basin volume ratio as defined below:

$$\frac{V_B}{V_T} = \frac{\text{Sed. Basin Volume}}{\text{Storm Runoff volume}} = \text{Sed. Basin volume ratio}$$

18. Calculate the emptying rate for each particle size during quiescent periods.

$$\Omega_i = v_{si} A_B$$

Ω_i = emptying rate for particle size "i", (ft³/sec)

19. Calculate the emptying ratio for each particle size during inter-event periods. The emptying ratio is a unit-less ratio therefore convert variable to the appropriate units so that they cancel out.

$$E_i = \frac{\Delta_m \Omega_i * 3600 \frac{sec}{hr}}{V_T}$$

E_i = emptying ratio for particle size "i", (unit less)

Δ_m = mean interval between 2012 storm mid points, (hr)

20. Use the sed. basin volume ratio and the emptying ratio with the nomograph in Figure 6.6-24 to determine the effective sed. basin volume ratio for each particle size.

$$\frac{V_{Ei}}{V_T} = \text{Effective Sed. Basin Volume Ratio for particle size "i"}$$

Figure 6.6-24: Sedimentation Basin Nomograph 1

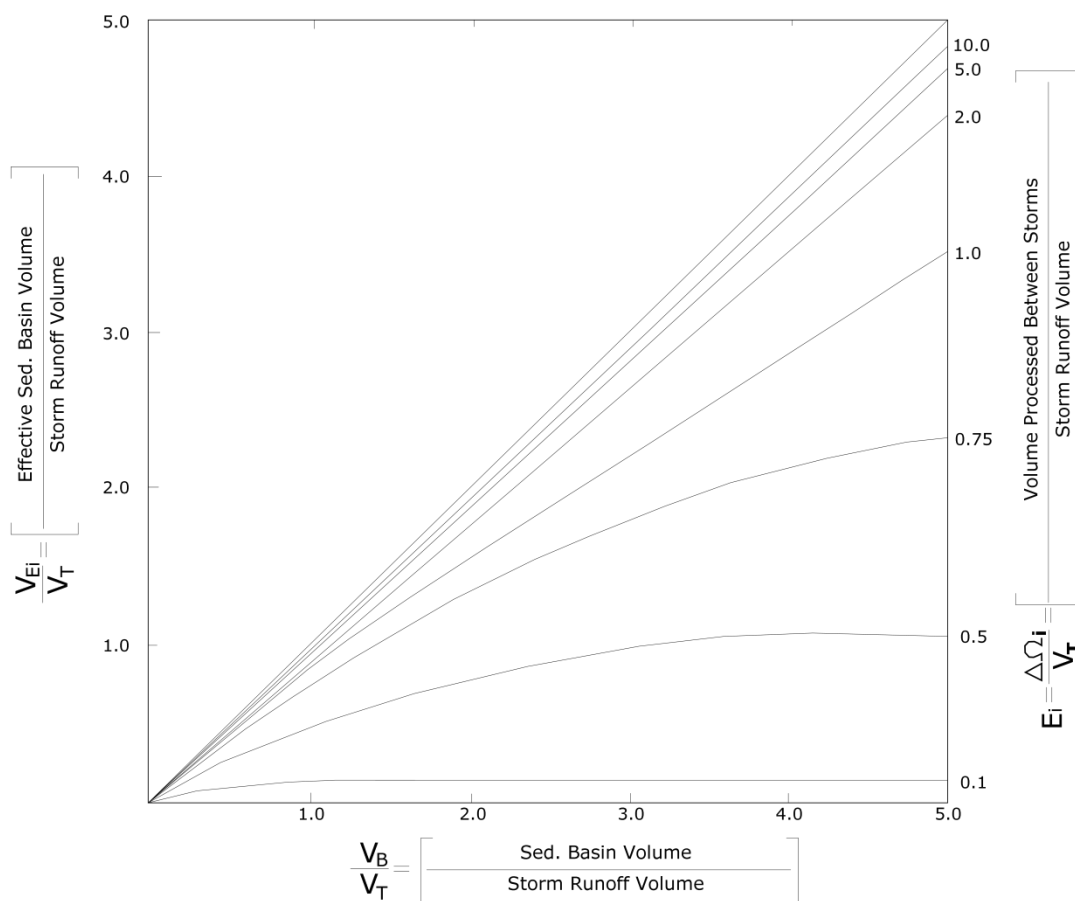

21. Use the effective sed. basin volume ratio and coefficient of variance for storm runoff volume with the nomograph below (Figure 6.6-25) to determine the quiescent percent removal for each particle size. Only the turning line for the $COV_R = 1.317$ is shown from the original paper. 1.317 matches the specific statistical runoff data for Anchorage weather patterns.

$COV_R = 1.317$, Coefficient of Variance for Storm Runoff Volume $R_{Qi} =$ Quiescent removal efficiency for particle size i , (%)

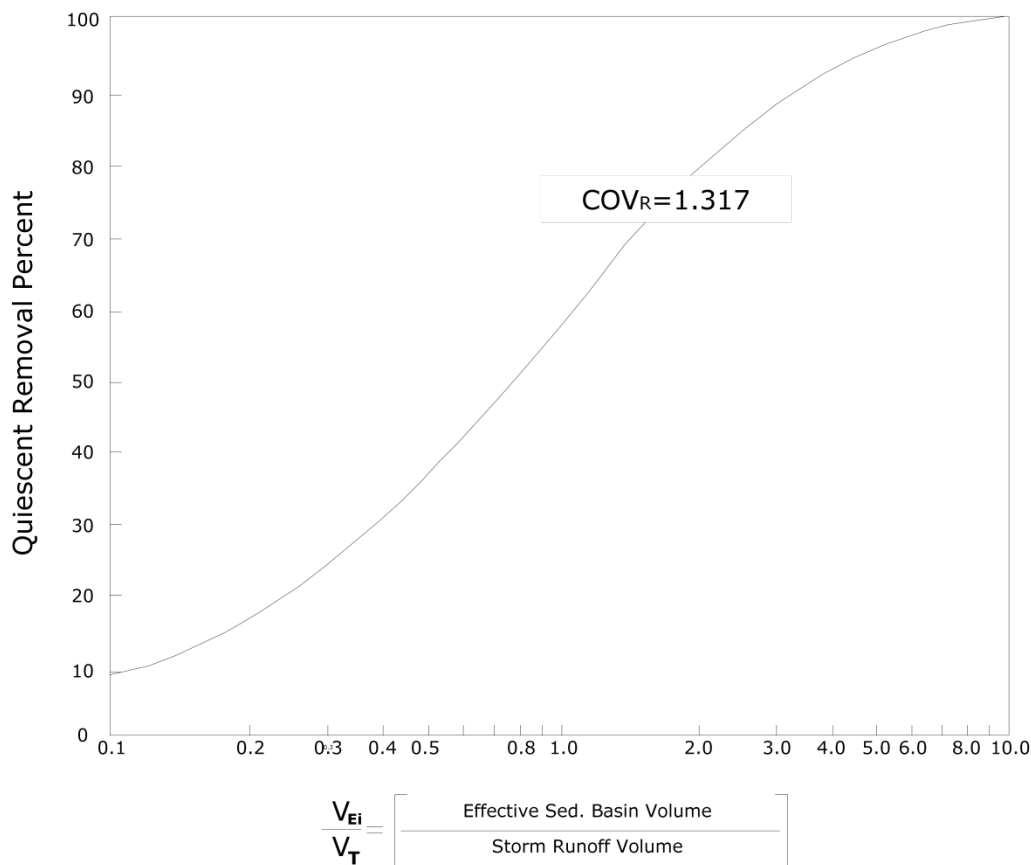
Figure 6.6-25: Sedimentation Basin Nomograph 2

The quiescent removal percent for each particle size denotes the percent of particles with a particular size which settle between storm events.

22. Calculate the weighted average quiescent removal efficiency for all particles (similar to step 15), and determine the fraction of particles not removed by quiescent settling.

$$f_Q = 1 - R_{Q \text{ average}}$$

f_Q = fraction of particles not removed through quiescent settling

23. The Annual percent of sediment captured is determined with the equation below.

$$\text{Annual \% Sediment Captured} = [1 - (f_Q \times f_D)] \times 100\%$$

f_Q = fraction of particles not removed through quiescent settling

f_D = fraction of particles not removed through dynamic settling

24. Annual sediment captured $\geq 80\%$ will satisfy the treatment performance criteria. If annual

percent sediment captured is less than 80% the basin geometry should be changed to increase dynamic treatment and/or quiescent treatment. Alternative evaluation techniques may be used to calculate annual sediment removal but must be documented for approval.

25. Replace the assumed basin performance outlined in step 2 (80%) with the theoretical basin performance, recalculate the required storage volume. Verify the constructability and performance parameters of the sedimentation basin if the sediment storage volume is adjusted.

Operation and Maintenance Manual:

The operation and maintenance manual should include a description and supporting documents for the following items:

- A. Project Description
- B. Hydrologic Description
- C. Design Description
- D. Performance Analysis
- E. Maintenance Plan

Maintenance:

Provision for periodic basin cleaning and sediment removal is an important element in the overall design of sedimentation basins.

Provide maintenance equipment access to the site for sediment removal, maintenance of inlet and outlet structures, vegetation maintenance, and trash removal. A hardened forebay will facilitate cleaning and an area should be provided to temporarily store dredged sediment. This area should drain back into the sedimentation basin. Include provisions for routing flows around the facility during maintenance activity.

Table 6.6-22: Summary of Maintenance Activities for Sedimentation Basins

Activity	Frequency*
Routine inspections (after the first few months)	Twice a year (following spring snowmelt and before first snowfall)
Sediment removal	Every 5 to 25 years as needed
Trash and debris removal	Twice a year
pest control	As needed

**Alternate maintenance schedules may be submitted for approval for projects within municipal ROW. Coordinate with Street Maintenance and PM&E.*

6.6.17 Oil and Grit Separators

<p>Description</p> <p>A structure designed to improve stormwater quality primarily by removing floatable pollutants such as oil and grease and by removing sediments with attached pollutants.</p>																								
<p>Stormwater Management Suitability</p> <table border="0"> <tr> <td colspan="2">Runoff:</td> <td rowspan="3">Suitable to meet or help meet requirements for:</td> </tr> <tr> <td>Rate Control:</td> <td>Low</td> </tr> <tr> <td>Volume Reduction:</td> <td>Low</td> </tr> <tr> <td colspan="2">Implementation Considerations:</td> <td></td> </tr> <tr> <td>Land Requirement:</td> <td>Low</td> <td>Pre-treatment ✓</td> </tr> <tr> <td>Capital Cost:</td> <td>High</td> <td>Traditional Water Quality Treatment ✓</td> </tr> <tr> <td>Accepts Hotspot Runoff:</td> <td>Yes</td> <td></td> </tr> <tr> <td>Maintenance:</td> <td>High</td> <td></td> </tr> </table>			Runoff:		Suitable to meet or help meet requirements for:	Rate Control:	Low	Volume Reduction:	Low	Implementation Considerations:			Land Requirement:	Low	Pre-treatment ✓	Capital Cost:	High	Traditional Water Quality Treatment ✓	Accepts Hotspot Runoff:	Yes		Maintenance:	High	
Runoff:		Suitable to meet or help meet requirements for:																						
Rate Control:	Low																							
Volume Reduction:	Low																							
Implementation Considerations:																								
Land Requirement:	Low	Pre-treatment ✓																						
Capital Cost:	High	Traditional Water Quality Treatment ✓																						
Accepts Hotspot Runoff:	Yes																							
Maintenance:	High																							
<p>Key Considerations</p> <p>Advantages:</p> <ul style="list-style-type: none"> • Easily accessed for maintenance • Longevity is high, with proper maintenance • Standardized designs allow for relatively easy installation <p>Limitations:</p> <ul style="list-style-type: none"> • No volume control • Limited pollutant removal <p>Design:</p> <ul style="list-style-type: none"> • Some systems have high-flow bypass built in, but many will require a separate bypass for high flows and/or maintenance access. • Systems should be designed to meet the performance goals specified in this section. 																								

General Description:

The oil and grit separator (OGS) is a structure designed to improve stormwater quality primarily by removing floatable pollutants such as floating trash, oil, and grease and by removing sediments and the associated pollutants that adhere to sediments. Oil and grit separators can be used as a pre-treatment for other structural stormwater controls, or may be used as effective traditional stormwater treatment in certain situations.

Advantages:

- Can be used for retrofitting small urban lots where larger facilities are not feasible or where

above-ground systems are not an option.

- B. Provides pretreatment of runoff before it is delivered to other systems.
- C. Easily accessed for maintenance.
- D. Longevity is high, with proper maintenance.
- E. Standardized designs allow for relatively easy installation.
- F. Compatible with storm drain systems.

Limitations:

- A. Limited pollutant removal compared to other types of treatment facilities.
- B. No volume control.
- C. Require scheduled, periodic maintenance as well as removal and proper disposal of trapped sediment and oil/grease.
- D. Expensive to install and maintain, compared to other types of systems.
- E. Cannot be used for the removal of dissolved or emulsified oils such as coolants, soluble lubricants, glycols, and alcohols. Also relatively ineffective on naturally buoyant organic particles.
- F. Requires a bypass system for maintenance access which, in some cases, may require additional manholes, valves, and piping.

Design Flow Rate:

- A. Unlike many other structural stormwater controls, an OGS is sized based on a flow rate, not a treatment volume.
- B. The design peak flow rate is computed using the rational method (as described in Section 4) with a design peak intensity of 0.12 inches/hour.

Sediment Loading:

- A. Sediment loading is based on average annual accumulation on the impervious surfaces of the contributing area. Standard values for Anchorage are presented in Table 6.6-23.

Table 6.6-23: Average Annual Sediment Loading

Impervious Area Type	Average Sediment Loading
Parking Areas	1500 (lbs per acre)
Primary Roads	2000 (lbs per curb mile)
Secondary Roads	1000 (lbs per curb mile)

- B. Annual sediment loading to the OGS is calculated as follows:
- C. Compute the total curb miles per road type and the parking lot acreage.
- D. Multiply the curb miles and parking lot areas by the average sediment loads in Table 6.6-23 to define the sediment loading.
- E. If catch basins are used as part of the treatment process, multiply the sediment load by 42% to

account for the sediment capture by catch basins. If catch basins are not used for treatment, skip this step. **NOTE: Catch basin configuration must comply with the requirements of Section 6.6.15 of this manual to be considered acceptable for treatment.**

- F. This value is the annual washed off sediment load in pounds.

Required OGS Certifications:

- A. The New Jersey Department of Environmental Protection (NJDEP) maintains a testing protocol and certifies OGS standardized testing. Their protocol refers to these devices as Hydrodynamic Sedimentation Manufactured Treatment Devices or HSMTD. Only hydrodynamic oil and grit separators tested and certified per the NJDEP protocol and meeting the sediment removal efficiencies as stated herein are approved for use. Hydrodynamic or other separators with mechanical screens or filters are more maintenance intensive and require a variance for use.
- B. An OGS device must meet the NJDEP protocol and have received NJDEP certification.
- C. A listing of NJDEP certified treatment devices is maintained at the following link:
<http://www.nj.gov/dep/stormwater/treatment.html>.

Device Selection Procedure:

- A. Determine the peak flow, as described above.
- B. Identify an NJDEP certified device that has a maximum hydraulic flow rate (MHFR) greater than or equal to the peak flow from the design storm. This is the maximum permissible flow rate through the separator before turbulence and velocities mobilize previously captured sediment and pollutants (scour).
- C. Ensure that the device has a total yearly suspended solids percentage capture (% TSS Capture) of 50% or greater.
- D. Determine the annual volume of captured sediment. To do this, first calculate the weight of the annual sediment captured by the OGS by multiplying the NJDEP certified % TSS capture rate by the annual washed off sediment load (computed as-described above.) Convert the weight to volume using 90 lbs/ft³ density.
- E. The available storage volume of the OGS must be 2.5 times the annual volume of captured sediment, computed above. The available storage volume is set by the manufacturer and verified during NJDEP sour testing to ensure that captured sediment doesn't become re-suspended and travel downstream.

Additional Design Requirements:

- A. A side-splitting diversion or other bypass is required for flood flow, unless the system has capability to produce treatment for higher flows, the system has an internal high flow bypass, or another device is approved by the Municipal Engineer.
- B. For public projects, a side-splitting diversion is required for maintenance access in all cases. Approval of the bypass design is required by Street Maintenance. Coordination with Street Maintenance early in the design process is encouraged to help ensure that bypass design meets maintenance needs and remains as practical as possible.
- C. Install a heavy truck access route adjacent to the oil and grit separator inlet, outlet, and cleanout

manholes for maintenance.

- D. OGS lids and access ports shall conform to the requirements of MASS.
- E. Incorporate straight-line access to entire trap compartment for a Vactor wand. All sediment trap areas must be accessible in a straight line from access manholes.

Maintenance:

Oil and grit separators installed on private property shall be maintained by the property owners.

Table 6.6-24: Summary of Maintenance Activities for Oil and Grit Separators

Activity	Frequency*
Collection, removal, and proper disposal of oil and used sorbent material	Once a year
Clean out sediment	Once every two years
Inspect for sediment accumulation levels and damage, including reduced capacity, corrosion, and settling	Once a year

**Alternate maintenance schedules may be submitted for approval for projects within municipal ROW. Coordinate with Street Maintenance and PM&E.*

6.7 Gravel Check Dam

Gravel check dams are used to reduce the velocity of flow or impound a volume of water in a ditch or swale as shown in Figure 6.7-1. By reducing the velocity of the runoff, check dams reduce the potential for ditch erosion. By impounding a volume of water, check dams allow for infiltration or filtration of the water quality volume. Note that check dams can be constructed from other materials such as concrete with weirs included. Dams constructed of other materials should be designed with consideration given to relevant loads and overturning forces.

Selection:

Gravel check dams are appropriate for any ditch where the runoff velocity is no greater than six fps. They can be appropriate for higher velocities if appropriate measures are used to protect the dam stability and prevent erosion of the channel bottom. Check dams installed in grass lined structures may kill the vegetative lining if siltation is excessive or the dam remains submerged for extended periods of time. Rock check dams are used in narrow ditches and gullies.

Gravel check dams should be constructed from angular rock, sized for the design flow velocity. They should be keyed into the surrounding earth to prevent erosion. The check dams should be placed closer together on steeper slopes. The layout of the check dams must be done in a manner that overtopping of the ditch does not occur. Runoff from the contributing drainage area and associated velocities should be evaluated during design.

Maintenance:

Cleaning is required if the rocks become half full of sediment. If the earth near the check dam is eroded, the area must be stabilized with rocks or other materials.

- A. Look for sediment filling the check dam.
- B. Check to see if the area near the check dam is eroded.
- C. Look for erosion in the ditch between check dams.
- D. Check for overtopping of the ditch.
- E. Repair check dam voids and undercuts.
- F. See Figure 6.7-1: Gravel Check Dam.

Figure 6.7-1: Gravel Check Dam

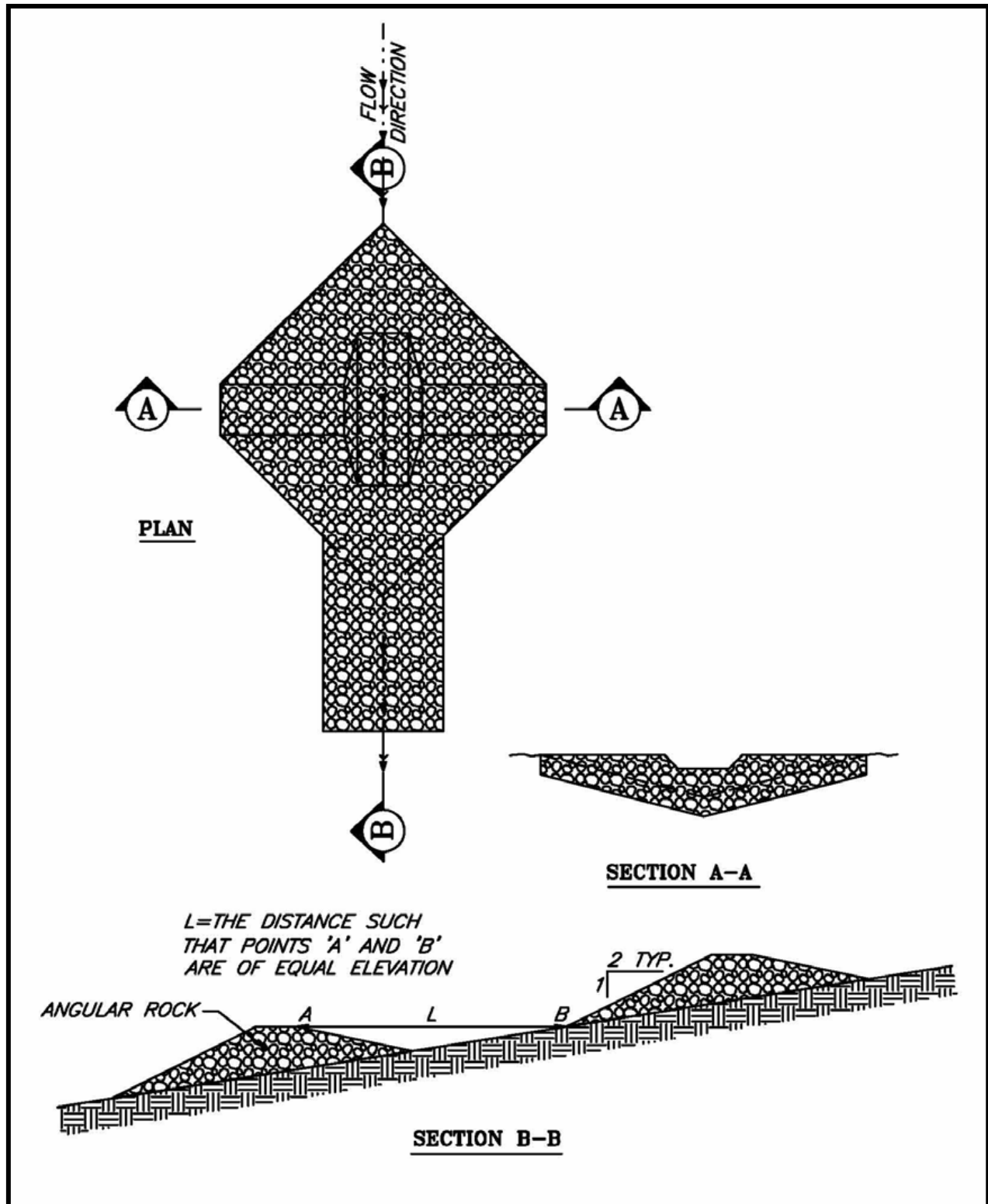

6.8 Outlet Protection and Riprap

Stormwater that is transported through man-made conveyance systems at design capacity can reach velocities that exceed the capacity of the receiving channel or area to resist erosion. To prevent scour and minimize the potential for downstream erosion, velocities must be reduced to acceptable levels before the flow enters an unprotected area.

Outlet protection is a permanent control that prevents scour at pipe outlets and reduces the velocity of the concentrated discharge. There are many types of outlet protection that can be considered based on site-specific conditions. Some common types of outlet protection include riprap aprons, riprap basins, and riprap revetments. Riprap revetments are also used to protect side slopes and embankments from erosion due to high velocity flows or wave action.

Selection of the appropriate outlet protection measure should be based on specific site parameters such as slope of the receiving channel, flow rate and velocity of the design discharge, and characteristics of the native soil. The design procedures are different for various types of outlet protection and riprap configurations.

6.8.1 Riprap Apron

Because of its low cost and ease of installation, a riprap apron is a commonly used practice when high-velocity discharge must be released on erodible soils. Riprap aprons are only applicable in cases where the discharge pipe is level with the receiving channel (not elevated) and the apron in the receiving channel can be designed at a zero slope.

Figure 6.8-1: Riprap Apron Schematic

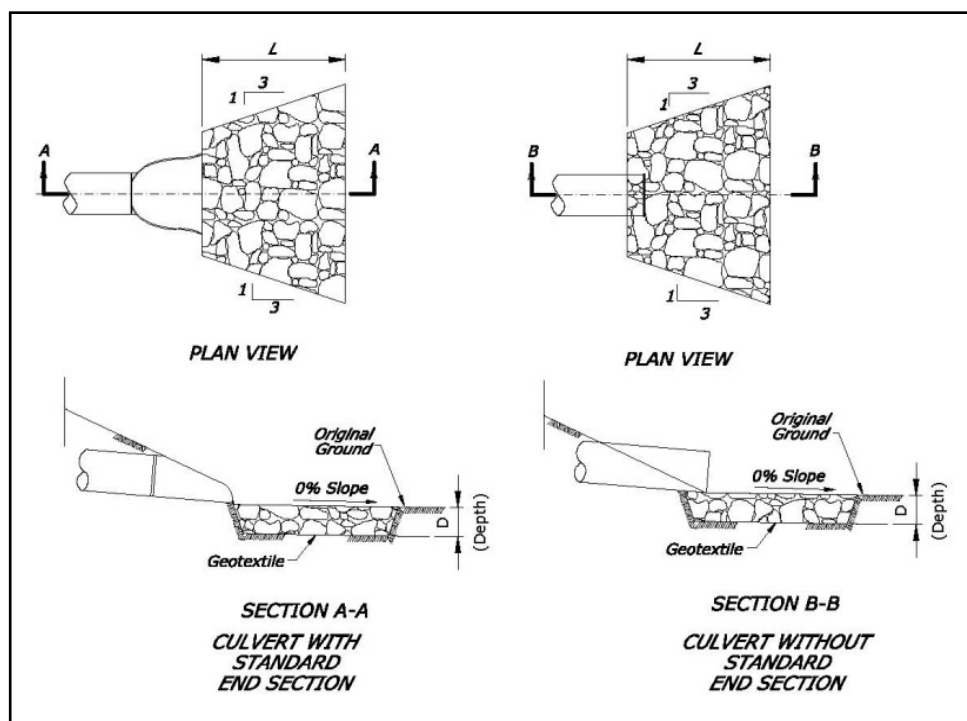

Source: Federal Highway Administration HEC-14

Riprap apron design should be performed in accordance with HEC-14. The design process is outlined below and can also be found in HEC-14 online at:

<http://www.fhwa.dot.gov/engineering/hydraulics/pubs/06086/hec14ch10.cfm>

The following equation provides a D_{50} riprap size for an apron accepting discharge from circular culverts:

$$D_{50} = 0.2D \left(\frac{Q}{\sqrt{g}D^{2.5}} \right)^{\frac{4}{3}} \left(\frac{D}{TW} \right)$$

Where:

D_{50} = Riprap size, ft

Q = Design discharge, cfs

D = Culvert diameter (circular), ft

TW = Tailwater depth, ft

g = Acceleration due to gravity, 32.2 ft/s²

The tailwater depth for this should be limited to between 0.4D and 1.0D. If tailwater is unknown, use 0.4D.

Whenever the flow is supercritical in the culvert, the culvert diameter is adjusted as follows:

$$D' = \frac{D + y_n}{2}$$

Where:

D' = Adjusted culvert rise, ft

y_n = Normal (supercritical) depth in the culvert, ft

This equation assumes that the rock specific gravity is 2.65. If the actual specific gravity differs significantly from this value, the D_{50} should be adjusted inversely to specific gravity.

The designer should calculate D_{50} using the procedure described above and compare with available riprap classes. The class of riprap to be specified is that which has a D_{50} greater than or equal to the calculated D_{50} size. The apron dimensions must also be specified. Table 6.8-1 provides guidance on the apron length and depth. Apron length is given as a function of the culvert rise and the riprap size. Apron depth ranges from $3.5D_{50}$ for the smallest riprap to a limit of $2.0D_{50}$ for the larger riprap sizes. The final dimension, width, may be determined using the 1:3 flare shown in Figure 6.8-1 and should conform to the dimensions of the downstream channel. A filter blanket should also be provided as described in HEC-23, Chapter 5.

Table 6.8-1: Rip Rap Diameter and Apron Dimensions

D₅₀ (in)	Apron Length¹	Apron Depth
6	4D	3.3D ₅₀
10	5D	2.4D ₅₀
14	6D	2.2D ₅₀
20	7D	2.0D ₅₀
22	8D	2.0D ₅₀

¹D is the culvert rise.

For tailwater conditions above the acceptable range for this procedure (TW > 1.0D), follow the procedure outline in HEC-14.

Over their service life, riprap aprons experience a wide variety of flow and tailwater conditions. In addition, the relationships summarized in Table 6.8-1 do not fully account for the many variables in culvert design.

6.8.2 Riprap Aprons after Energy Dissipaters

Some energy dissipaters provide exit conditions, velocity and depth, near critical. This flow condition rapidly adjusts to the downstream or natural channel regime; however, critical velocity may be sufficient to cause erosion problems requiring protection adjacent to the energy dissipater. The equation below provides the riprap size recommended for use with downstream of energy dissipaters (HEC-14).

$$D_{50} = \frac{0.692}{S - 1} \left(\frac{V^2}{2g} \right)$$

Where:

D₅₀ = Median rock size, ft

V = Velocity at the exit of the dissipater, ft/s

S = Riprap specific gravity

The length of protection can be judged based on the magnitude of the exit velocity compared with the natural channel velocity. The greater this difference, the longer will be the length required for the exit flow to adjust to the natural channel condition. A filter blanket should also be provided as described in HEC-23.

6.8.3 Other Riprap Applications

Many other types of riprap configurations are available for situations where riprap aprons are not appropriate, such as on culvert outlets where a zero slope is not achievable, or armoring the sides of a channel or an embankment. In these cases, applications such as riprap revetment, riprap basins, or other types of energy dissipaters and/or erosion control applications should be considered. Detailed design procedures for various riprap applications can be found in the FHWA publications HEC-14 and HEC-23. The link for HEC-14 is provided in the previous section. HEC-23 can be found online at the links below:

HEC 23 Volume 1: (web version)

<http://www.fhwa.dot.gov/engineering/hydraulics/pubs/09111/page00.cfm>

HEC 23 Volume 2:

<http://www.fhwa.dot.gov/engineering/hydraulics/pubs/09111/09112.pdf>

6.8.4 Implementation

The installation must conform to the required lines and grades shown in the plan. All elements of the outlet protection installation should follow the plans and specifications. Designs will vary based on discharge specifics and receiving area conditions.

6.8.5 Maintenance

Outlet protection should be inspected after heavy rains to see if any erosion has occurred or if rock has been dislodged. All repairs should be made immediately to prevent further damage.

- A. Look for and correct erosion at the outlet.
- B. Check that rocks are in place and replace them as necessary.
- C. Ensure that any geotextile installed is in working order.
- D. Remove sediment when it fills the voids between rocks.

7.0 BETTER SITE DESIGN PRACTICES

7.1 Introduction to Better Site Design Practices

Low Impact Design (LID) is a stormwater management strategy that focuses on maintaining or restoring the natural hydraulic functions of a site for the purpose of water resources protection. LID uses a decentralized approach that disperses flows and manages runoff closer to where it originates, as opposed to collecting stormwater in a piped or channelized network and managing it at a large-scale “end of pipe” location. This management practice focuses on mimicking the natural retention, filtration, and infiltration mechanisms that stormwater runoff would encounter on an undeveloped site. Therefore, the most important factor to consider in the application of LID to site design is the preservation of native vegetation and natural drainage features.

An essential part of the LID approach is conserving portions of the site in its pre-developed state to preserve the hydrologic functions of the site. To achieve this, site planners should identify and preserve areas that most affect hydrology, such as streams, wetlands, floodplains, steep slopes, and high-permeability soils. The development layout should be adjusted to reduce, minimize, and disconnect the total impervious area. Finally, on-site options for handling runoff from the impervious areas should be employed before conventional off-site stormwater practices are used.

In addition to the importance of preserving native vegetation and natural drainage features, gains are made in the effort to mimic natural conditions by reducing and or disconnecting proposed impervious surfaces. Areas of pavement that can be easily broken up into multiple disconnected impervious surfaces include traffic lanes, parking lots, and paved walkways. Traffic lanes can be separated by pervious medians that receive runoff from roadway surfaces. Parking lots can be designed to incorporate vegetated strips of land to collect and convey runoff. Paved walkways can be separated from roadways by vegetated strips of land providing not only opportunities for infiltration but also increase pedestrian safety.

LID practices also provide water quality benefits. Overall reduction in surface runoff reduces the volume of runoff that can potentially transport pollutants. Infiltration as an LID technique reduces the mass of pollutants by filtration of particles and adsorption of chemicals to soil.

There are numerous site design practices that can will aid in water quality and stream protection. This section provides only a brief description of some of these practices that are versatile and relatively easy to implement. There are multiple additional resources for detailed descriptions of many other site design practices and considerations. The designer is encouraged to explore the resources provided below and incorporate better site design techniques as much as possible.

7.2 Descriptions of Specific Better Site Design Practices

7.2.1 Create Parking Lot Stormwater “Islands”

Parking lots can be designed with landscaped stormwater management “islands” which reduce the overall impervious cover of the lot as well as provide for runoff treatment and control in stormwater facilities. When possible, expanses of parking should be broken up with landscaped islands which include shade

trees and shrubs. Fewer large islands will sustain healthy trees better than more numerous very small islands.

The most effective solutions in designing for tree roots in parking lots use a long planting strip at least eight feet wide, constructed with sub-surface drainage and compaction resistant soil. Structural control facilities such as filter strips and bioretention areas can be incorporated into parking lot islands. Stormwater is directed into these landscaped areas and temporarily detained. The runoff then flows through or filters down through the bed of the facility and is infiltrated into the subsurface or collected for discharge into a stream or another stormwater facility. These facilities can be attractively integrated into landscaped areas and can be maintained by commercial landscaping firms. For detailed design specifications of various structural stormwater controls, see Section 6.

7.2.2 Use Buffers and Undisturbed Areas

Runoff can be directed towards riparian buffers and other undisturbed natural areas delineated in the initial stages of site planning to infiltrate runoff, reduce runoff velocity and remove pollutants. Natural depressions can be used to temporarily detain and infiltrate water, particularly in areas with well infiltrating soils.

The objective in utilizing natural areas for stormwater infiltration is to intercept runoff before it has become substantially concentrated and then distribute this flow evenly (as sheet flow) to the buffer or natural area. A bypass for higher flow events should be provided to reduce erosion or damage to a buffer or undisturbed natural area. Carefully constructed berms can be placed around natural depressions and below undisturbed vegetated areas with porous soils to provide for additional runoff storage and/or infiltration of flows.

7.2.3 Use Vegetated Swales Instead of Curb and Gutter

Where density, topography, soils, slope, and safety issues permit, vegetated open channels can be used to convey and treat stormwater runoff from roadways. Traditional curb and gutter and storm drain systems allow for the quick transport of stormwater, which results in increased peak flow and flood volumes and reduced runoff infiltration. Curb and gutter systems also do not provide treatment of stormwater that is often polluted from vehicle emissions, unmanaged pet waste, lawn runoff and litter. Vegetated channels along a roadway remove pollutants by allowing infiltration and filtering to occur, unlike curb and gutter systems which move water with virtually no treatment. Engineering techniques have advanced the roadside ditches of the past, which suffered from erosion, standing water and break up of the road edge. Grass channels and bioretention areas are alternatives to traditional curb and gutter systems, and with proper installation under the right site conditions, they are excellent methods for treating stormwater on-site. In addition, vegetated channels can be less expensive to install than curb and gutter systems.

7.2.4 Drain Runoff to Pervious Areas

Stormwater quantity and quality benefits can be achieved by directing the runoff from impervious areas to pervious areas such as lawns, landscaping, filter strips and vegetated channels. This “disconnects”

runoff from conveyance systems, increases the site time of concentration, and promotes infiltration and sediment removal. Some methods for disconnecting impervious areas include:

- A. Designing roof drains and gutters to flow to vegetated areas;
- B. Directing flow from paved areas such as driveways to stabilized vegetated areas; and
- C. Locating impervious areas and grading landscapes such that these areas will intercept sheet flow from impervious areas.

For maximum benefit, runoff from impervious areas to vegetated areas should occur as sheet flow and vegetation should be stabilized to avoid damage.

7.2.5 Think Small

Stormwater benefits and better site design practices are often considered on a large scale. However, significant benefits can be achieved by making small changes, even at the individual home level. Below is a list of small-scale site design practices that can make a considerable difference in overall stormwater runoff quality and quantity.

- A. Drain roof gutters into rain barrels that can later be used to water the garden or lawn.
- B. Direct roof gutters and down drains to lawns and gardens instead of driveways.
- C. Slope driveways to lawns or gardens instead of immediately to the street.
- D. Direct runoff from impervious areas into small, aesthetic rain gardens.
- E. Consider paver blocks or other types of pervious surface cover for driveways.

7.3 Recommended Resources

There are numerous sources available that present additional ideas for better site design practices. An excellent recommended reference is the Georgia Stormwater Management Manual, Volume 2 Technical Handbook. This manual provides additional details for the site design practices described above as well as multiple additional design ideas and practices. It is available online at <http://www.georgiastormwater.com/>.

Intentionally Left Blank

8.0 SNOW STORAGE REQUIREMENTS

8.1 Snow Melt Guidelines

The impact of snow melt on runoff is important because it can cause flooding during spring breakup. Substantial runoff volumes can be produced because frozen ground is relatively impermeable and infiltration is minimal.

PM&E has conducted a study of snow melt in Anchorage using meteorological data collected at Anchorage International Airport over the period 1968 to 1977. The March 10, 1969 event was selected as representing the model or most frequently occurring snow melt event. The March 23, 1974 event was selected as representing an event with approximately a five-year recurrence interval. The equivalent snow melt hyetograph for the peak period of each of these two events is shown included in Appendix D.

Until better snow melt data are developed, design snow melt runoff shall be computed by using the five-year recurrence hyetograph in Appendix D. The snow melt hyetograph should be applied to all areas without orographic adjustment. However, the engineer should note that the 10-year design storm event rather than snow melt usually governs for pipe sizing.

8.2 Snow Storage and Snow Disposal Site Design Criteria

8.2.1 Introduction

Snow disposal sites provide storage areas for snowfall that exceeds the storage capacity of street ROW and other public facilities. The criteria established in this section are for snow disposal sites managed by the MOA, the DOT&PF, and private disposal sites.

Guidance for on-site private snow storage and ice control is included in a white paper in Appendix I. Contact PM&E for updated information.

Objective:

The objective of these design criteria is to provide project managers and site designers with information needed to site, design, and operate snow disposal sites that are safe, efficient, and protective of surface water and groundwater quality. Water quality concerns for melt water include chloride and other salts, suspended sediment, turbidity, and metals associated with sediment and turbidity.

Besides storing snow, snow disposal sites are designed to discharge melt water through a combination of infiltration and surface discharge. Siting criteria, design features, and operational procedures described in this section are all intended to manage the impacts of discharges on receiving waters and potable groundwater resources by using the three principles:

- A. Maximize appropriate infiltration,

- B. Minimize sediment and other pollutants in melt water, and
- C. Provide for pollutant dilution.

Codes and Review Process:

These siting, design, and operational criteria provide a framework for preparing plans for commission reviews or for approvals required under various portions of the AMC, as listed below. Note that the AMC is continually being revised; always refer to the most recent printed edition.

For all sites:

- A. AMC 21.15.015 - Public facility site plan review requires a review by the Planning and Zoning Commission of any snow disposal site.
- B. AMC 21.15.025 - Public facility project landscaping review by the Urban Design Commission is required for public facilities and land use permits.

In addition, for private and SOA sites:

- C. AMC 21.40.200.B.1 - Light industrial district lists snow disposal sites as a conditional use that requires an annual administrative permit.
- D. AMC 21.15.055 - Annual administrative permit establishes the annual administrative permit.
- E. AMC 21.15.030 - Approval of site plans and conditional uses outlines general requirements for site plan approval.
- F. AMC 21.50.270 - Conditional use standards - snow disposal sites outlines specific requirements for snow disposal sites. In particular, this section requires submitting a drainage and water quality plan and a dust and litter control plan.
- G. AMC 21.67 - Stormwater discharge establishes stormwater discharge restrictions and requires a system plan review.
- H. AMC 15.70.080 - Property line noise emission standards establishes noise standards.
- I. AMC 21.05.115 - Implementation - Anchorage Wetlands Management Plan establishes guidelines for managing wetlands.

8.2.2 Site Selection Criteria

Site selection criteria consider effects of on-site infiltration and effects of surface discharges on surface water including lakes, streams, and wetlands.

- A. Snow disposal sites are not permitted within 200 feet of a Class A or B well or within 150 feet of a Class C well (ADEC, Snow Disposal Area Siting Guidance 2007). For disposal sites that are located more than 200 feet and less than 1,000 feet up-gradient from a Class A or B well, or more than 150 feet and less than 1,000 feet up-gradient from a Class C well, perform an engineering evaluation of the potential impact of dissolved solids on groundwater.
- B. Snow disposal sites are not permitted within 500 feet up-gradient of an on-site sewage-disposal system.
- C. Avoid areas with high potential for contaminating potable water aquifers. The intent is to prevent

melt water with a high salt content from entering and contaminating these aquifers.

- D. Assess potential for such infiltration for both the site itself and for the complete flow path of the melt water. This site selection criterion shall be addressed by a Professional Engineer, hydrogeologist, or other professional experienced in Anchorage area surficial geology and in the hydrology and interaction of groundwater and surface water.
- E. Avoid areas with high potential for contaminating closed lake or wetland systems. Melt water from snow disposal sites shall not be discharged to closed basin surface water features that have few or no surface water outlets.
- F. Avoid sites that would discharge to streams with a base (winter) flow of less than three cfs. Minimum receiving water discharge is based on probable adequacy for assimilation of chloride releases from snow melt to achieve compliance with the EPA and SOA water quality criteria. PM&E can provide maps of streams, site-specific channel geometry, baseline stream chemistry, and estimates of stream base flow throughout the MOA.

On-site dilution of snow site melt water may be performed prior to discharge to meet treatment goals listed in Section 8.2.4 under the second subheading.

- G. Select sites that offer optimum opportunity for infiltration to shallow, non-potable groundwater systems. This site selection criterion is secondary to criteria protecting potable aquifers, wetlands, lakes, and streams.
- H. Avoid sanitary landfills and gravel pits. Snow meltwater will create more contaminated leachate in landfills posing a greater risk to groundwater. Additionally, in gravel pits there is little opportunity for pollutants to be filtered out of the meltwater because groundwater is close to the land surface.
- I. Avoid disposing of snow on top of storm drain catch basins or in stormwater drainage swales or ditches. Snow combined with sand and debris may block a storm drainage system, causing localized flooding. A high volume of sand, sediment, and litter released from melting snow also may be quickly transported through the system into surface water.
- J. Snow disposals sites should not be located in sections of parks or playgrounds that will be used for direct contact recreation after the snow season. Accidental ingestion of soils contaminated with metals can be detrimental to human health, especially in children. Areas in parks, such as parking lots, which are not used for public recreation, can serve as disposal sites.
- K. Avoid sites that would negatively impact wetlands. Melt water from snow disposal sites shall not be discharged to wetlands such that the discharge significantly reduces overall functionality (as catalogued in the Anchorage Wetlands Management Plan and its cited documents) of either the entire contiguous wetland feature or the impacted fraction alone.
- L. Research of stormwater impacts to Anchorage wetlands is continuing. Planners and designers should review the criteria and contact PM&E for site-specific and/or more current information.
- M. Select sites that offer optimum opportunity for slope and aspect orientation. Sites shall be selected that are generally suitable for constructing storage pads that are sloped down from south to north. Note that the aspect of sites need not be northerly, but sites should be amenable to constructing pads sloping generally from south to north.

8.2.3 Design Information

The following information is required for snow disposal site design:

Soil Investigation:

A soil investigation is performed to provide knowledge of the soil and potential problems with geotechnical concerns such as freeze/thaw effects, deep and shallow groundwater infiltration characteristics, and other constraints to site construction. Soils analyses shall conform to criteria in Chapter 1 Section 1.7 of the DCM.

A detailed soils report is required for determination of marginal conditions for site stability due to high groundwater, high infiltration rate, high potential for saturation, or erosion concerns.

Surveying and Mapping:

A map shall be created to document watercourses, stormwater features, and other criteria that may be affected by the site. Mapping shall include the following features:

- A. Site topography with two-foot or more detailed contour intervals;
- B. Existing roads, culverts, ditches, storm drains, and other drainage features;
- C. Location and depth of domestic wells and on-site sewage disposal systems within 500 feet of site boundaries;
- D. Surface water features within 500 feet of the site, including wetlands, creeks, and lakes;
- E. Ultimate receiving waters for melt water flows.

Groundwater Investigation:

A site-specific groundwater investigation shall be conducted to protect potable aquifer supplies and receiving waters. Site-specific groundwater levels (seasonal high and low), gradient, direction, uses of the local aquifer, and probable hydraulic connections to potable groundwater aquifers within a 1,000-foot radius shall be compiled or determined. The investigation shall also specifically address shallow non-potable groundwater systems that may be suitable for receiving infiltrated snow melt water from the disposal site.

8.2.4 Specific Design Criteria

In snow disposal site design, include a constructed pad for snow storage with separate area(s) for any other wastes to be stored at the site as well as design features for water retention and discharge. Manage discharged water to meet stated water quality objectives. These site-specific design criteria serve as the basis of the drainage and water quality plan required under AMC 21.50.270.

Snow Storage Pads (see Figures 8.2-1 and 8.2-2):

- A. Pad Orientation - Orient v-swale snow storage pads preferentially with the downslope (discharge) ends of swale axes to the north.
- B. Pad Design - Snow disposal shall take place on a compacted working surface composed of competent native material or select imported fill. Construct snow disposal pads to have single or

multiple v-swale cross-sections. A v-swale shall have a two percent side slope and a longitudinal slope of one to two percent. Each v-swale shall have a minimum width from crest to crest of 150 feet. Pads may be constructed of a single v-swale spanning the width of an entire site, or of a continuous series of v-swales. However, given the operational requirements of v-swales and the required side slopes, a series of minimum-sized v-swales may be generally preferable to one large swale.

- C. **Berm Design** - Berms shall be a minimum of three feet in height and generally placed continuously along the outer perimeter of the snow disposal site pad. Berms are constructed with competent native material or select imported fill. Construct berms to have 2:1 side slopes and a one-foot minimum crest width. Place armor and seepage protection as specified under the section on channel and berm armoring. It is not intended for snow to be placed against the berms and berms are intended to be free from the erosional forces of melt water flows.
- D. **Pad Vegetation** - Vegetate all unarmored snow storage pad surfaces. A vegetated surface is essential to properly operate a snow disposal site. Vegetation resists pad erosion, traps fine sediments mobilized in snow melt, and promotes absorption of metals and other pollutants. Select and design a vegetative mix that is resistant to seasonal shallow burial (one to two inches of loose sand fill annually) and to elevated concentrations of salt and metals. Recommended seeding specifications are provided in Appendix J.

When constructing pads, cat-track all v-swale side slopes immediately prior to revegetation. Cat-tracking consists of imprinting the ground surface with crawler tractor tread marks along the fall line (i.e., trafficking directly upslope and downslope).

- E. **Channel and Berm Armoring** - Armor all critical pad surfaces and flow channels, provide permanent and temporary setback markers, and accommodate for icing storage in select armored channels. Maintain the elevation of all armored surfaces slightly depressed below and feathered to the vegetated pad surfaces to assure flow of melt water onto and across armored surfaces and not parallel to it. All armor shall be at least six inches thick with all finished armored surfaces feathered to the finish grade of the vegetated pad. Size armoring material according to expected flow velocities (peak discharge of snow melt from snow disposal sites can be up to one cfs). See Section 6.8 of this manual for riprap sizing guidance. In particular, perform the following:
 - 1. Construct armored surfaces along the centerline of each v-swale; along the crests of all multiple, interior v-swales; along the toe of all perimeter and interior berms; along all discharge channels; and at all discharge points (see Figure 8.2-1).
 - 2. Armor from an elevation of one foot up from the toe of each berm and extending down the side of the berm and across the pad surface for a distance of 15 feet from the toe of the berm.
 - 3. Armor a 20-foot wide band in front of the toe of the end perimeter berm for the full width of the lower end of each v-swale.
 - 4. Armor both sides of the crest of each interior v-swale for a distance of ten feet from the top of the crest.
 - 5. Armor the central (longitudinal) channel of each v-swale to a minimum width of 15 feet.
 - 6. Immediately beneath the surface armor along the centerline of each v swale install a french drain one foot by one foot in cross section comprised of washed rock wrapped in geotextile

cloth. End each french drain structure at an outlet drain structure six feet wide by 12 feet long and 1.5 feet thick with one end of the outlet drain placed against the upstream face of the v-swale's outlet weir. The outlet drain shall be comprised of washed rock contained on the sides and bottom with geotextile cloth, with the top of the washed rock placed flush with the surface of the surrounding perimeter pad armoring.

7. Provide subdrain or other design elements along all discharge channels to accommodate decreased channel flow capacity lost to icing storage early in the melt season.
- F. Pad Outlet Weirs - To accommodate flow measurements and melt water sampling, construct rectangular outlet weirs or other device acceptable to PM&E at the end of each v-swale, or at each pad outlet point where multiple v-swales are served by a single discharge channel.
- G. Snow Poles - Set permanent snow poles as snow storage setback guides at a distance of ten feet from the toe of the end perimeter berm and five feet from the toe of all interior and lateral berms. Poles shall be at minimum 12 feet in height and marked with reflective tape along the top one foot. Where multiple v-swales are constructed, provide supports for temporary setback poles along the interior crests of all v-swales.

Melt Water Detention and Discharge:

Provide ponds for early season melt water detention and/or infiltration and for late season sedimentation. Specific design criteria for detention basins are included in Section 6.6. Supplementary criteria and criteria deserving emphasis are described below.

- A. Detention Pond Design - Detention pond design is based primarily on hydrologic characteristics of the melt water from snow sites and secondarily on sediment removal rates. Design the detention pond for minimum storage volume at the beginning of winter. Minimum storage volume in ponds above allotted sediment and ice/snow storage shall include all runoff from the March 23, 1974, snow melt hyetograph for a 40-hour duration (see Appendix D).

The pond treatment goal for sediment, as measured at the point of pond discharge, is 95 percent removal of all particle sizes greater than 100 μm in diameter.

Storage volume goals for ponds above allotted sediment and ice/snow storage shall provide for dilution of melt water so that treatment goals for chloride are met.

Melt water properties for design purposes are:

1. Seven-day average concentration of 3,000 parts per million (ppm) chloride in one cfs of melt water.
2. 30-day average concentration of 1,000 ppm in 0.5 cfs of melt water.

Melt water properties are based on 1998-2001 winter street maintenance practices. Melt water properties could significantly change with changes to these Municipality-wide maintenance practices. Please contact PM&E for any changes to these design criteria.

Thresholds for chloride exposure recommended by the MOA are shown in Table 8.2-1. These values may change; check with PM&E for current chloride threshold values.

Table 8.2-1: Recommended Thresholds for Chloride Exposure

Exposure Duration	Fish and Invertebrates	Vegetation
Acute (less than 1 week)	3,600 mg/L	6,400 mg/L
Acute (up to 30 days)	1,200 mg/L	3,200 mg/L
Chronic (continuous)	300 mg/L	640 mg/L

- B. Outlets - Provide floating oil-absorptive booms guyed around all detention pond outlets. Provide cleanout access aprons at all inlets to detention ponds. Provide heavy maintenance vehicles access to all pond control structures. Provide for dispersion of all melt water discharge into wetlands and for flow energy dissipation at discharge points into lakes and streams. Design wetland dispersion structures to limit the size of wetland impact zones while assuring flows low enough to prevent erosion and extended, artificial ponding.

Waste Sediment Areas:

Provide separate storage areas with proper drainage and access for any waste sediment storage proposed for sites. Access to storage areas shall not require the traversing of any part of snow storage areas or their immediate access routes. Drainage from any sediment storage areas may be directed to snow site detention ponds but shall not be directed across any portion of snow storage pads.

8.2.5 General Design Criteria

General site design criteria, including lighting, noise control, parking, signage, landscaping, fencing, and traffic access, are specified in AMC 21.50.270 and in Chapters 3 and 5 of the DCM. Supplementary criteria are described below.

Traffic Access:

- A. Prohibit uncontrolled vehicular access to the site. A lockable gate shall be provided.
- B. Construct access driveway with a minimum width of 24 feet and a maximum width of 34 feet.

Lighting/Illumination:

- A. Consider installation of permanent lighting at all disposal sites anticipated to be operated while dark. Safety is the primary reason for lighting; lighting for disposal operations is a secondary concern.
- B. Strategically locate lighting at vehicular access points, retention basins, or other necessary areas. Provide a minimum of 0.3-foot candles at these locations. Pay particular attention to adjoining property users to meet glare requirements of AMC 21.45.080 Paragraph W.4.a. Additional information on lighting is provided in Chapter 5 of the DCM.

Landscaping:

The MOA Urban Design Commission must approve landscaping plans for snow disposal sites; Chapter 3 of the DCM provides guidelines. Supplementary criteria are described below.

- A. Ensure that landscaping on the outside of site berms and buffer areas provides year-round visual enhancement where possible. Plant woody vegetation away from equipment circulating and maneuvering areas.
- B. Provide vegetative ground cover for non-armored areas of snow disposal pads. Ground cover is necessary for proper functioning of pads. Select salt-tolerant plants and perform maintenance as necessary on an annual basis.
- C. Consider installation of an inexpensive irrigation system to be used at least during plant establishment periods.

Noise:

The facility design must address noise at adjacent and other affected properties per AMC 15.70.080.

8.2.6 Snow Disposal Operational Practices

Operations include managing litter, placing snow in winter, and maintaining vegetation in summer. Proper operation of snow disposal sites is essential to snow disposal site performance. Improper operations of snow disposal sites will result in increased pollutant release. In case of private sites, these considerations are incorporated into dust and litter control plan required under AMC 21.50.270.

Snow Placement (see Figure 8.2-1):

- A. Place snow across the full width of each v-swale. If multiple interior swales are used in a site design, fill must be placed across either the full width of all swales or across the complete width of one or more swales. Swales must not be filled across some fraction of their width or only on one side along their length. Non-conformance will increase turbidity in melt water.

As necessary, install and use temporary snow poles along interior swale crests. These poles help operators prevent partial filling of adjacent swales when operations call for filling just one interior swale.

Sequence the placement of hauled snow starting at the downhill side of the site and filling uphill (always across the full width of each swale cross section) to minimize erosion of dirt released from the snowpack during the latter stages of melt.

Place snow in a single fill layer over the entire available storage space before stacking snow on top of earlier fill. Thicker snow masses substantially increase initial leached chloride concentrations.

Maintain snow fill in as compact a mass as possible; never place snow as isolated and separate piles. Place snow such that sides are as steep and close to vertical as possible. Compact, steep-sided snow fills reduce release of sediment from the sides of the snow fill where mobilization of these sediments readily occurs.

- B. Maintain a snow fill setback from all berms. Maintain a ten-foot setback from the end of v-swales

and a five-foot setback from all side berms. Snow fill should be placed to overlap armor adjacent to the berms but not extend past setback markers.

Vegetation:

Maintain vegetation of all non-armored pad surfaces. With proper initial application of an appropriate seed mix, very little attention should be required to promote seasonal growth of vegetation across the surface of snow storage pads. Little or no mowing should be required. However, regrading of sites shall be absolutely prohibited or limited to maintaining the functionality of the site, particularly in the late melt season. Confine access to pads or to control structures to traffic along armored features.

Materials Storage:

Materials storage practices must incorporate techniques to manage sediment transport from snow storage facilities for on-going pollutant control. Sediment management practices may incorporate techniques presented in Chapters 8 and 6 of this document or may utilize other generally accepted source control practices. At a minimum, management practices must ensure that 1) snow is not placed or stored over sediment that is left after snow piles have melted; and 2) snow is not placed or stored over other materials stored on the site or left behind from other uses. Use of the facility for activities other than snow storage shall not compromise the performance of snow storage controls.

Figure 8.2-1: Multiple V-Swale Snow Site Design Concept

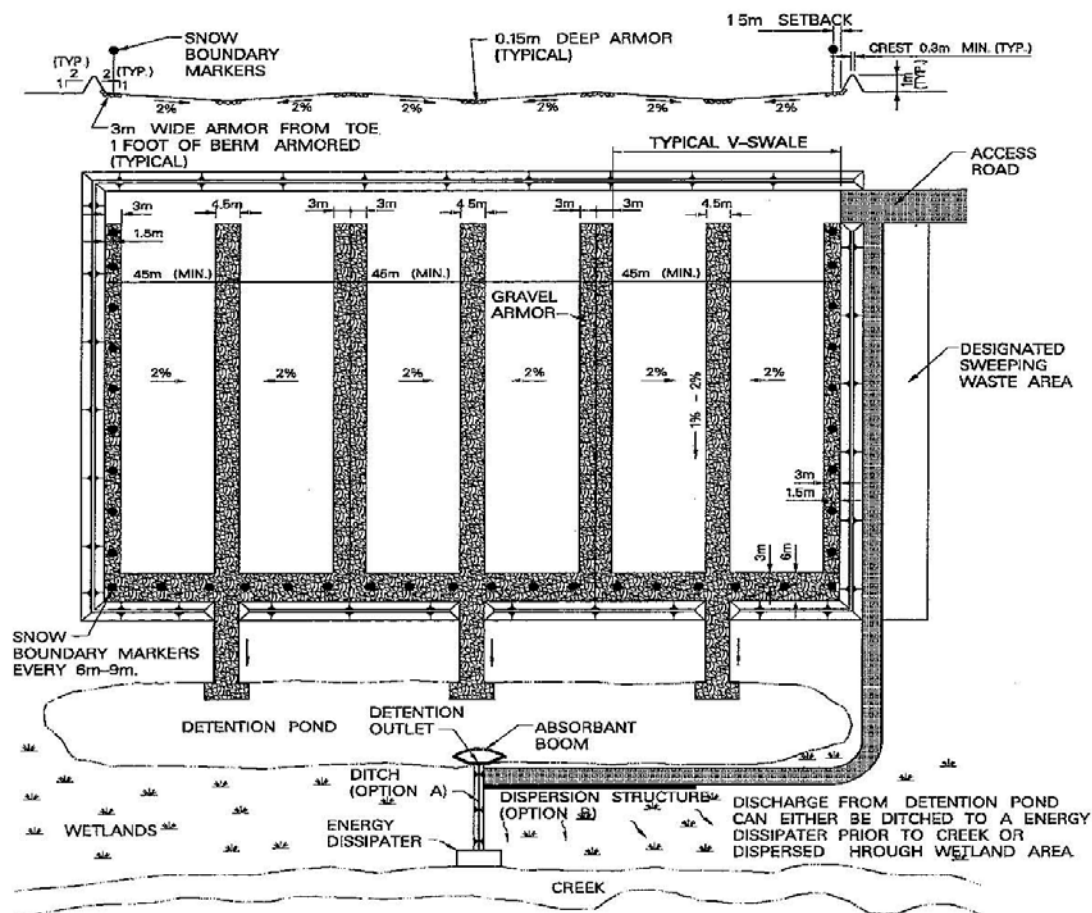
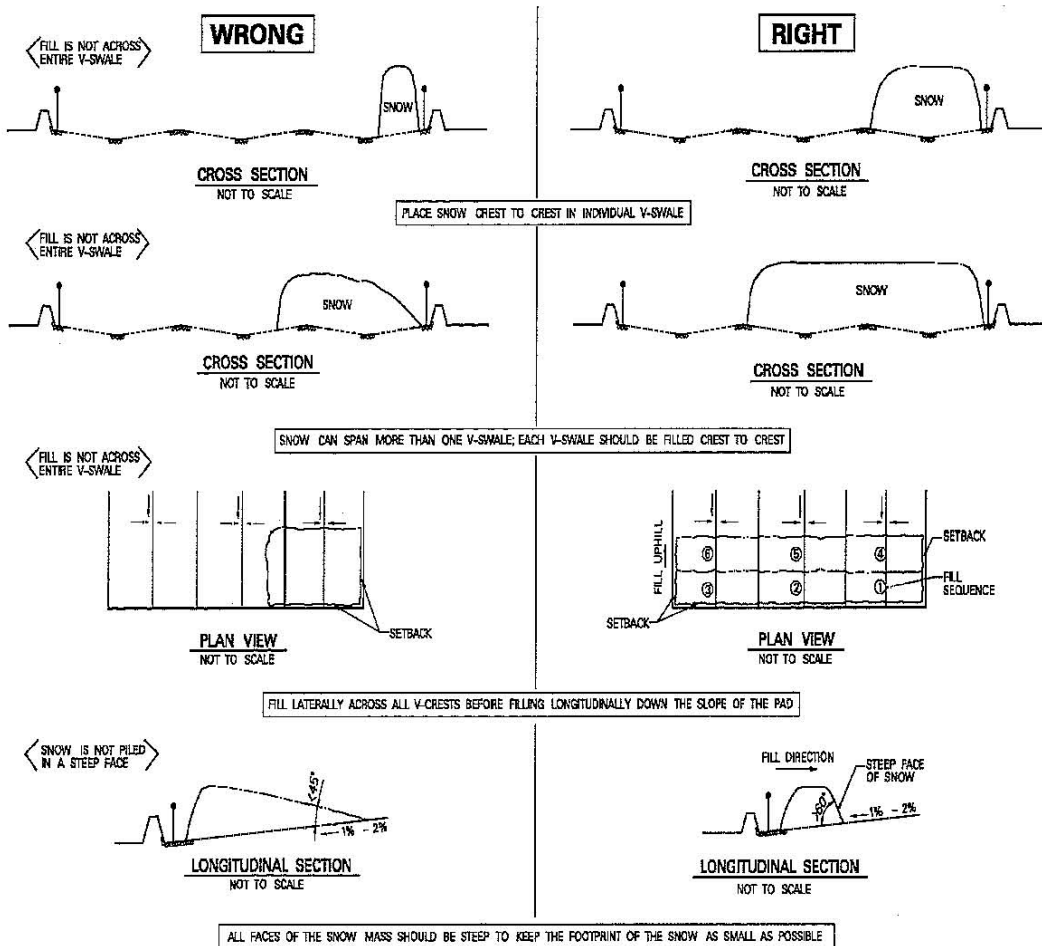

Figure 8.2-2: Snow Site Fill Procedure



9.0 REFERENCES

The following documents were instrumental in the development of this manual:

Alaska Highway Drainage Manual. Alaska Department of Transportation and Public Facilities. 2006.

Authorization to Discharge Under the National Pollutant Discharge Elimination System. Permit Number AKS-052558. United States Environmental Protection Agency. 2010.

Authorization to Discharge Under the National Pollutant Discharge Elimination System Fact Sheet. United States Environmental Protection Agency. Permit Number AKS-052558. 2009.

Comprehensive Urban Hydrologic Modeling Handbook, First Edition. Nicklow, John W., Boulos, Paul F., and Muleta, Misgana K. Pasadena, CA: MWH Soft. 2006.

Construction General Permit, United States Environmental Protection Agency. April 2011.

Drainage Criteria Manual, Chapter 5 Calculation of Runoff. City of Springfield, Missouri. 2007.

Design Criteria Manual, Chapter 2 Drainage. Municipality of Anchorage. 2007.

Drainage Design Guidelines. Municipality of Anchorage. 2007.

Guidance Specifying Management Measures for Sources of Nonpoint Pollution in Coastal Water. United States Environmental Protection Agency 840-B092-002. January 1993.

Hydrology National Engineering Handbook, Part 630 Hydrology, Chapter 16 Hydrographs. United States Department of Agriculture, National Resources Conservation Services. Washington, DC. 2007.

Iowa Stormwater Management Manual, 2C-7 Runoff Hydrograph Determination, Version 2. Iowa State University Institute for Transportation. 2008.

Low Impact Development Design Guidance Manual. Municipality of Anchorage. 2008.

Highway Hydrology: Hydraulic Design Series Number 2, Second Edition; Publication No.: FHWA-NHI-02-001, (HDS-2), prepared for Federal Highway Administration. McCuen, R.H., Peggy A. Johnson, Robert M. Ragan. Arlington, Virginia, October 2002:.

Minnesota Stormwater Manual. Minnesota Pollution Control Agency, St. Paul, MN, January 2008.

Minnesota Urban Small Sites BMP Manual. Barr Engineering Company. 2001.

Performance of Sedimentation Basins and Oil/Grit Separators at Anchorage, Alaska. Wheaton, Scott R., et al. Municipality of Anchorage Watershed Management Program, January 2013.

Stormwater Management Guidebook. Center for Watershed Protection, Ellicott City, MD, August 2012.

Stormwater Management Manual, Volume 2, First Edition. Atlanta Regional Commission et al. *Georgia* 2001.

Tennessee Erosion and Sediment Control Handbook, Second Edition. Tennessee Department of Environment and Conservation. 2002.

Urban Hydrology for Small Watersheds. United States Department of Agriculture, National Resources Conservation Services. Technical Release 55. Washington, DC. 1986.

Virginia Stormwater Management Handbook, Volumes 1 and 2, First Edition. Virginia Department of Conservation and Recreation. 1999.

Websites:

EPA NPDES Program <https://www.epa.gov/npdes>

Appendix A:

Drainage Certification and WMS Mapping Forms

Intentionally Left Blank

Drainage Certification Form – Part A

Applicant Name		Contact Information (Phone and/or email)	
Mailing Address			
Property Description (subdivision, lot(s), and block)			
Plat Number		MOA Assessor's Office Property Identification Number	
MOA Tracking Number(s) Indicate which is provided)			
Project Category (Check one)	<input type="checkbox"/> Small <input type="checkbox"/> Medium (This form is not applicable to other project types. Small Projects are not required to submit Part B.)		
Project and/or Report Title			

By signature below, I certify that (initial all that apply):

_____ The project will disturb less than 10,000 square feet of land area. (Small project)

_____ The fractions of impervious, lawn or other landscaping, and naturally vegetated landcover types present at pre-development of the project will not change by more than 5% as a result of the proposed development. (Medium project)

_____ The entire project area does not exceed 0.75 acres. (Medium project)

_____ The project is a fill and grade permit for a residential single family home or duplex involving only one lot with less than 5,000 CY of fill material. (Medium project)

In addition, I certify (must initial) that:

_____ Watercourse mapping for this project area previously approved by WMS or the MOA Planning Department's wetlands staff accurately represents current conditions.

I certify under penalty of law that this information was prepared under my direction or supervision. This information is, to the best of my knowledge and belief, true, accurate, and complete. I am aware that there are penalties, including the possibility of fine and imprisonment, for knowing violations.

Signature

Date

Drainage Certification Form – Part B

Medium projects are required to comply with the stormwater treatment requirements described in Chapter 3. Please complete the following sections and include relevant attachments to demonstrate compliance.

1. If your project has received approval for traditional stormwater treatment or alternative compliance, please check the appropriate box below and attached relevant approvals or MOA correspondence.
 - Project has approval for traditional stormwater treatment
 - Project has approval for alternative compliance
 - Not applicable

2. Green Infrastructure treatment must be provided for runoff from the first 0.52 inches of rainfall. Please check all types of facilities you are incorporating into your project to meet this requirement.
 - Bioretention
 - Soak-away Pits
 - Infiltration Basin
 - Infiltration Trenches
 - Vegetated Swales
 - Pervious Pavement
 - Chamber Systems
 - Filter Strips
 - Landscaped Depressions
 - Canopy Cover/Vegetation Retention
 - Other (please list) _____

3. If your facility(s) has approval for traditional treatment, describe the traditional treatment.

4. Is this facility(s) designed in accordance with MOA design criteria presented in the 2016 Anchorage Stormwater Manual Volume 1 (Design Criteria Manual Chapter 2)? Yes No

5. Attach a general plan view drawing and section of the facility(s).

6. Is the facility(s) designed for more than the 0.52 inch event? Yes No

7. Provide the facility(s) design volume. (Filter Strips, Vegetated Swales, and Oil Grit Separators that are designed with a peak intensity may skip this question.)

Attach supporting computations. See page 4-17 of the ASM Volume 1 for instructions on computing this volume.

8. Describe each facility's overflow or bypass system for events larger than the design event. _____

9. Describe the facility(s) maintenance plan. Include a description of maintenance activities and proposed frequency. (Recommended maintenance for various stormwater facilities is included in Chapter 6 of the ASM Volume 1.)
10. Attach the completed Operation and Maintenance Agreement included in Appendix B of the ASM Volume 1.

I certify under penalty of law that this information was prepared under my direction or supervision. This information is, to the best of my knowledge and belief, true, accurate, and complete. I am aware that there are penalties, including the possibility of fine and imprisonment, for knowing violations.

Printed Name _____ Name of Firm _____

Signature _____ Date _____

Phone _____ Email _____

Required attachments: (Include additional attachments as needed to demonstrate compliance.)

- Facility plan view and section
- Volume Computations
- Stormwater Operation and Maintenance Agreement (Note: If desired, a draft agreement may be submitted for projects that will be issued a Conditional Certificate of Occupancy (CCO). A final agreement will be required before a CCO is issued.)
- Additional Attachments. Please list.

Intentionally Left Blank

Drainage Project Notification and WMS Mapping Request

Applicant Name *		Contact Information * (Phone and/or email)	
Mailing Address *			
Property Description * (subdivision, lot(s), and block)			
Plat Number		MOA Assessor's Office Property Identification Number	
MOA Tracking Number(s) (Indicate which provided)			
Project Category * (Check one)	Crossing <input type="checkbox"/> Single-Lot Residential <input type="checkbox"/> Class 1A <input type="checkbox"/> Class 1B <input type="checkbox"/> Class 1C <input type="checkbox"/> Class 1D Small <input type="checkbox"/> Simple <input type="checkbox"/> Complex Large <input type="checkbox"/> Simple <input type="checkbox"/> Complex		
Parcel Physical Location * (Address and/or driving directions)			

Requested Services*

- Review of complete watercourse mapping (must submit mapping to be reviewed)

- Watercourse site review services
 - Feature flagging
 - Notification prior to site visit requested.
 Notifications will be made using the contact information provided; however, contact cannot be guaranteed. Scheduling for applicant presence on site also cannot be guaranteed.
 Requested completion date: _____. (Preferred completion date)
 No later than completion date: _____ (Later completion may incur significant project delay).
 Dates and service availability cannot be guaranteed. Scheduling is based on Planning Department priorities, request receipt order, and seasonal constraints (at minimum, mapping review requires canals to be free of snow and ice.)

* Required Information

Attachments:

- Watercourse mapping (to scale) clearly showing all known streams and major drainageways (reconnaissance level or final depending on service) and the name and location(s) of receiving waters

Certification:

By signature below, I certify that I am legally entitled to authorize the requested services and that the attachments provided are complete and accurate representations of known site conditions and project plans. I further authorize Municipality of Anchorage (MOA) personnel to access the referenced site on foot for the purposes of identifying and / or mapping drainage features.

This form and its attachments constitute my notice to the MOA that I am developing plans for a drainage project or platting action and will be submitting a report of existing or proposed drainage conditions. I understand that all drainage projects are governed by the MOA Project Management and Engineering Design Criteria Manual, the MOA Drainage Design Guidelines, the Anchorage Municipal Code, and other state and federal regulations and permits.

Signed
Date

Intentionally Left Blank

Appendix B:

Sample Operations and Maintenance Agreement and Annual Reporting Form

Intentionally Left Blank

RECORD IN THE ANCHORAGE RECORDING DISTRICT, THIRD JUDICIAL DISTRICT, STATE OF ALASKA

After Recording Return to:

MOA Public Works, Watershed Management Section
P.O. Box 196550
4700 Elmore Road
Anchorage, AK 99519-6650

STORMWATER FACILITY OPERATION AND MAINTENANCE AGREEMENT

The Municipality of Anchorage (hereinafter the "Municipality") and _____

(hereinafter the "Owner(s),") enter into the following AGREEMENT TO OPERATE AND MAINTAIN STORMWATER FACILITIES (hereinafter "this Agreement") which shall become effective on the date the Agreement is fully executed.

The Owner(s) is/are a(n) _____, and _____ execute(s) this Agreement on behalf of the Owner(s) in the capacity of _____ and warrant(s) he/she/they has/have authority to execute this Agreement on behalf of the Owner(s).

The Owner(s) own(s) a parcel of real property (hereinafter "the Property") described as: _____

per plat _____, located in the Anchorage Recording District, Third Judicial District, State of Alaska.

Parcel ID: _____

1.0 RECITALS

1.1 In connection with the Owner's proposed development of the Property, the Municipality has required and the Owner agreed to construct stormwater facilities and to implement an operation and maintenance plan. Stormwater facility design and the operation and maintenance plan were prepared by the engineering firm of _____ for the Owner's property.

1.2 The upkeep and maintenance of stormwater facilities and the implementation of stormwater best management practices (BMPs) is essential for promoting safe and effective drainage and for protecting the integrity of the community's water resources. This agreement contains specific provisions with respect to maintenance of stormwater facilities and the use of stormwater BMPs.

1.3 Whereas, Owner has constructed improvements, including but not limited to, buildings, pavement, and stormwater facilities on the property described above. In order to further the drainage and water quality goals, the Municipality and the Owner hereby enter into this Agreement. The responsibilities of each party to this Agreement are identified below.

2.0 MAINTENANCE

THE OWNER SHALL:

- (1) Implement the stormwater facility maintenance program included herein as Attachment "A."
- (2) Execute periodic major maintenance on the stormwater facilities: including but not limited to: replacing damaged pipes, repairing inlet and outlet structures and resetting flow orifice sizes and elevations, as required.
- (3) Submit to the Municipality annually, documentation of the programs referenced in (1) and (2) above. The report should be submitted to:

MOA Public Works, Watershed Management Section
P.O. Box 196550
4700 Elmore Road
Anchorage, AK 99519-6650

Documentation must be delivered by November 30 of each calendar year. A reporting form is available from the Municipality. Documentation shall contain, at a minimum, the following:

- (a) Name address and telephone of the business, the person, or the firm responsible for operation and maintenance plan implementation, and the person completing the report.

- (b) Time period covered by the report.
 - (c) A chronological summary of the activities conducted to implement the programs referenced in (1) and (2) above. A photocopy of an applicable section of a logbook or work order, with any additional explanation needed, shall normally suffice. For any activities conducted by paid parties not affiliated with the owner, include a copy of the invoices for services.
- (4) Prevent unauthorized modifications to the drainage system and obtain written approval from the Director of Public Works (hereinafter the “Director”) before, grading, filling, and piping, or removing vegetation (except for routine and minor landscaping) that is part of the stormwater facilities. Modifications to stormwater facility quantity and quality controls may require the submittal of revised design drawings, supporting calculations, and modifications to maintenance requirements. The Owner shall obtain all necessary permits before performing all modifications approved by the Director.

THE MUNICIPALITY SHALL:

- (1) Provide technical assistance to the Owner in support of its operation and maintenance activities conducted pursuant to its operations and maintenance program. Said assistance shall be provided upon request, and as Municipality time and resources permit, at no charge to the Owner.
- (2) Review the annual report and conduct a site visit at least once every three years to discuss performance and provide assistance to the Owner.
- (3) Review this Agreement with the Owner and modify it as necessary.

3.0 REMEDIES

- (1) If the Municipality determines that maintenance or repair work, as outlined above in 2.0 Maintenance (1) and (2), is required to be done to the stormwater facilities on the Owner’s property, the Municipality shall give the Owner notice of the specific maintenance and/or repair required. The Municipality shall set a reasonable time in which such work is to be completed by the persons who were given notice; such time shall not extend beyond 30 days, subject to seasonal conditions and concerns. If the above required maintenance and/or repair is not completed within the time set by the Municipality, written notice to assess financial sanctions (AMC 21.13.040.A.4) and/or initiate enforcement proceedings.

- (2) If at any time the Municipality determines that the stormwater facilities create any imminent threat to public health or welfare, the Municipality may take immediate measures to remedy said threat. No notice to the persons listed in (1), above, shall be required under such circumstances.

4.0 ACCESS and FAILURE to MAINTAIN

- (1) The Owner grants unrestricted authority to the Municipality for access to any and all stormwater features for the purpose of performing inspection and maintenance or repair as may become necessary under Remedies (1) and/or (2).
- (2) The persons listed in Remedies (1) above, shall assume all responsibility for the cost of any maintenance or repairs to the stormwater facility. Such responsibility shall include reimbursement to the Municipality within 30 days of the invoice for any such work performed. Overdue payments shall accrue interest at the rate of ten percent (10%) per annum. If legal action ensues, all costs and fees incurred by the Municipality will be borne by the parties responsible for said reimbursements.

5.0 MODIFICATION or TERMINATION

- (1) Entire Agreement; Modification. This Agreement, together with any attachments and other documents referenced herein, sets forth the entire agreement and understanding of the parties under this Agreement, and supersedes all prior agreements, arrangements, understandings and negotiations. No modification of this Agreement shall be effective unless in writing and signed by authorized representatives of the parties to this Agreement.
- (2) Termination. If future conditions render the need for this agreement to expire or terminate, the authorized representatives of the parties shall agree in writing to conditions of termination that may include final inspections and restoration of the property. This Agreement shall not be recognized as terminated until those conditions have been completed and documented.

6.0 BINDING EFFECT

THIS AGREEMENT RUNS WITH THE LAND and inures to the benefit of and is binding upon the parties, their successors, heirs, representatives and assigns.

OWNER

By: _____
Name: _____
Title: _____
Date: _____

OWNER

By: _____
Name: _____
Title: _____
Date: _____

MUNICIPALITY OF ANCHORAGE

By: _____
Name: _____
Title: Public Works Director
Date: _____

STATE OF ALASKA) ss.
THIRD JUDICIAL DISTRICT)

The foregoing instrument was acknowledged before me this _____ day of _____,
20____, by _____, the Public
Works Director of the Municipality of Anchorage or his/her designee, on behalf of the
Municipality of Anchorage.

Notary Public in and for Alaska
My commission expires _____

STATE OF ALASKA) ss.
THIRD JUDICIAL DISTRICT)

The foregoing instrument was acknowledged before me this _____ day of _____,
20____, by _____,
in the capacity of _____.

Notary Public in and for Alaska
My commission expires _____

STATE OF _____) ss.
COUNTY OF _____)

The foregoing instrument was acknowledged before me this _____ day of _____,
20____, by _____,
in the capacity of _____.

Notary Public in and for _____
My commission expires _____

**OPERATIONS AND MAINTENANCE
ANNUAL REPORTING FORM**

DO NOT RECORD THIS PAGE

	<p>PERMANENT STORMWATER CONTROL ANNUAL REPORTING FORM</p>
---	--

This form must be completed and the certification signed by the facility owner or agent and returned to Watershed Management Service, with necessary attachments, by November 30th, for the prior November through October period of time.

GENERAL INFORMATION	
Owner Name (<input type="checkbox"/> check if new):	Reporting Period:
Facility Address:	November 1, 20 _____ to October 31, 20 _____
Contact Person (<input type="checkbox"/> check if new) Name: Phone Number(<input type="checkbox"/> check if new): Mailing Address (<input type="checkbox"/> check if new):	
INSPECTION INFORMATION	
Was maintenance required by the O&M Plan performed at this facility? (Please submit inspections logs or invoices documenting maintenance performed)	<input type="checkbox"/> YES <input type="checkbox"/> NO
Have any changes been made to the O&M Plan for the facility? (If yes, please attach additional documentation describing changes)	<input type="checkbox"/> YES <input type="checkbox"/> NO
Were any major repairs or replacements required? (If yes, please attach additional documentation describing changes)	<input type="checkbox"/> YES <input type="checkbox"/> NO
Please indicate if any of the following deficiencies were noted during your inspections	
<input type="checkbox"/> Vegetation outside the facility that is leaning unnaturally or lying on the ground	<input type="checkbox"/> Erosion or exposed dirt in or around the facility
<input type="checkbox"/> Standing water for long periods of time (3 or more days) after regular, small rainfall events	<input type="checkbox"/> Drainage problems downstream of the facility
<input type="checkbox"/> Indications of improper function or bypassing of stormwater flows	

I certify that to the best of my knowledge and belief the maintenance and inspection of the permanent BMPs is being implemented in accordance to the Post Construction Stormwater Facility Operation and Maintenance Plan for this property or that a notice of any deficiencies has been provided.

_____ Signature

_____ Date

ATTACHMENT A: Site Stormwater Operations & Maintenance Manual

ACME Shopping Center
1234 Any Road, Block 1 Lot 1 Some Subdivision
Anchorage, AK

Prepared for: John Doe

Prepared by: ABC Engineering, LLC

February, 2015

DO NOT RECORD THIS PAGE

Selected Permanent Stormwater BMPs (See Attached Figure)

The below section provides a brief description of stormwater BMPs unique to this site. Maintenance requirements for these facilities are discussed along with the more generic BMPs installed on-site in the Operation and Maintenance Schedule.

Vegetated Swale

To provide permanent stormwater treatment, a vegetated swale has been designed to direct stormwater flows to the piped storm drain system. The swale will act as a permanent control for the site. The swale is approximately 150 feet in length and is designed to provide treatment as well as regulate peak flows leaving the site. The outlet weir of the swale is designed to allow sediment to settle out prior to stormwater flows entering the storm drain system.

Bio-retention Area

A vegetated bio-retention area has been constructed to treat stormwater runoff from roofs and walkways. The bio-retention facility has been incorporated into the landscaping located at the front entrance to the building. The bio-retention is approximately 400 square feet in area. The facility has been fitted with a high flow intake designed for larger storm events and been fitted with an underdrain connected to the piped storm drain system.

General Site Operations and Maintenance Schedule**Parking Area**

- Parking area is to be swept twice annually to remove excess sediment. Recommended sweeping should take place once after spring melt and prior to May 15, and once after August 15 and prior to October 15.

Catch Basins, Stormdrain Manholes

- Annual Inspection to ensure that inlets and piping inverts are free from blockage
- Clean as required, or at least every three years

Oil and Grit Separator (OGS)

- Inspect twice during first year, per manufacturer
- Inspect annually to ensure that inlets and piping inverts are free from blockage
- Clean when sediment depth reaches 15% of capacity or in normal when catch basins require cleaning

Field Inlets, Curb Inlets

- Monthly inspection to ensure that inlets are free from blockage
- Remove trash and debris as needed

Vegetative Swale

DO NOT RECORD THIS PAGE

- Monthly inspection for trash and debris; remove as required
- Annual inspection for condition of soil and vegetation
- Re-vegetate and remove accumulated sediment as-needed

Bio-retention Area

- Maintenance and inspection of plant condition as part of normal landscaping, or at least once per year
- Replace dead plants as-needed
- Inspect annually for accumulated sediment, remove as necessary
- Inspect/maintain high flow inlet and riser as per field/curb inlets

DO NOT RECORD THIS PAGE

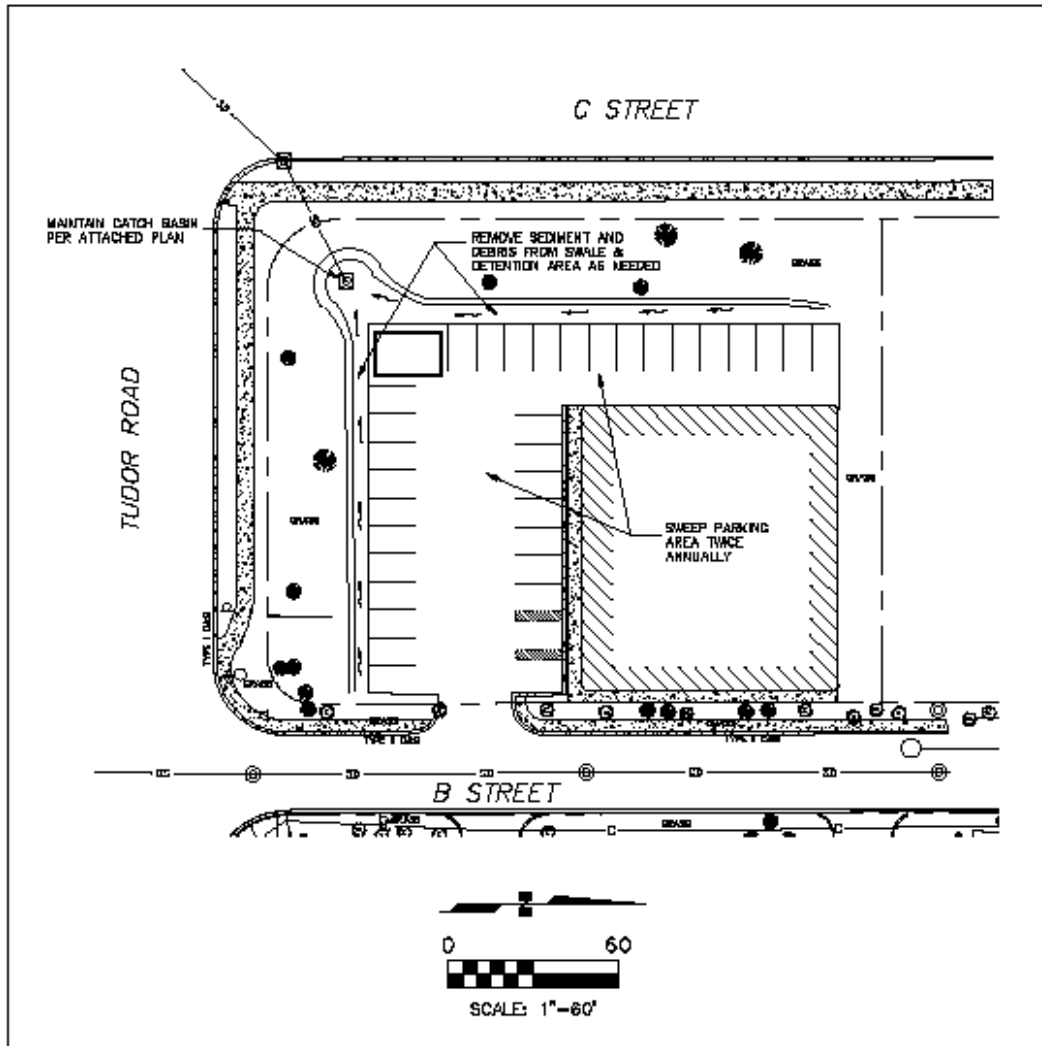

<p>MUNICIPALITY</p>  <p>OF ANCHORAGE</p>	<p>STORMWATER OPERATIONS AND MAINTENANCE MANUAL</p> <p>ACME SHOPPING CENTER</p> <p>1234 ANY ROAD, ANCHORAGE, AK</p>	
	OWNER'S INITIALS: <u>ABC</u>	PROJECT NO. <u>C19-1234</u>
	ATTACHED TO: <u>XYZ O&M MANUAL</u>	CAD DWG FILE: <u>O&M MANUAL.DWG</u>
PAGE <u>1</u> OF <u>1</u> DATED: <u>2/5/2015</u>	DESIGNED BY: <u>JRU</u> DRAWN BY: <u>CGS</u>	

DO NOT RECORD THIS PAGE

Intentionally Left Blank

Appendix C: Anchorage Drainage Studies Inventory

Intentionally Left Blank

Anchorage Drainage Studies Inventory

Document Name	Mo/Year	Author	Study Boundaries	Document Location/ WMS Ref. #	Notes	Study Type
Hood Creek Flood Bypass Rehabilitation Design Study	Mar-95	Montgomery Watson	Hood Creek- Jones Lake to Northern Lights Blvd.			Drainage
Fish Creek Improvements Northwood Drive to Minnesota Drive Conceptual Design Report	Feb-96	HDR	Northwood Dr. to Minnesota Dr.			Conceptual Design
Storm Drainage Study for Chester Creek	Aug-96	A.L. Renshaw/ H.P. Nicholson	Chester Creek	WMS - REP 18, 19, 441	Rational Method, 6-yr storm	Drainage
Glacier-Winner Creek Access Corridor Study - Draft Preliminary Routing Report	Nov-96	DOWL Engineers	Glacier-Winner Creek	HDR		Other
King Street/ 100th Ave. Upgrade: Dimond Blvd. to Old Seward Hwy.	Mar-97	USKH	King Street/ 100th Ave./ Dimond Blvd./ Old Seward Hwy.	WMS - REP 41		Design Study Report
Baxter Road/ Beaver Place Improvements Design Study Report	Sep-97	Lounsbury & Assoc. Inc.	Baxter Road/ Beaver Place	WMS - REP 6		Design Study Report
Chester Creek Wetland Hydrologic Analysis	Oct-98	HDR	Chester Creek	WMS - REP 372, 373	SWMM, Aug 98 storm	Other
Indian Creek Flood Analysis	Nov-98	HDR	Indian Valley	HDR	HEC-RAS, 100-yr event	Flood
Ship Creek Trail Design Study Report	Feb-99	USKH	Ship Creek Trail	WMS - REP 330		Design Study Report
Alyeska Creek Floodplain Study	Sep-00	HDR	Girdwood/ Alyeska Creek	HDR	HEC-RAS, 100-yr event, Technical Study Notebook	Flood
MOA Watershed Mapping - Hillside Drainage Atlas	Jan-03	Watershed Mgmt. Services	Hillside Area	WMS - CD 3, 4, 6		Atlas

Fish Creek Improvements Phase IV	Jan-03	HDR	Fish Creek Area & Basin	HDR	XPSWMM: SCS (HEC-1) & EPA 10-yr & 100-yr, 3 hr storm from Aug 1989	Design Study Report
Virgin Creek Floodplain Study	Aug-02	HDR	Girdwood/ Virgin Creek	HDR	HEC-RAS, Technical Study Notebook	Flood
Hydrology/Hydraulics Report for Meadow Creek near Eagle River, Alaska	Apr-04	W. F. (Skip) Barber	Meadow Creek			Hydrology Report
Furrow Creek Flood Study Hydrology Model Summary Report	Oct-07	HDR	Furrow Creek			Flood
Pilot Watershed Drainage Plan Little Rabbit Creek and Little Survival Creek Watersheds	Dec-07	HDR & WHPacific	Little Rabbit Creek and Little Survival Creek Watersheds	WMS	HEC-HMS, SCS 10-yr 24 hr analysis	Drainage
Potter Creek Watershed Drainage Plan	Nov-08	HDR and WHPacific	Potter Creek Watershed			Drainage
California Creek and Glacier Creek Flood Insurance Studies	Dec-08	HDR	Girdwood/ California and Glacier Creeks			Flood
Flood Insurance Study for Furrow Creek	Apr-09	HDR	Furrow Creek (lower portion)			Flood
Prospect Heights Drainage Evaluation	May 2016	HDR	Prospect Heights Subdivision	PM&E Project No. 14-33, Term Hydrology Task No. 7		Report

Appendix D: MOA Hyetographs

Intentionally Left Blank

Anchorage and Eagle River 24-hour Rainfall Distribution in 6-minute (0.1 hour) increments

Time (hr)	Cumulative Fraction	Time (hr)	Cumulative Fraction	Time (hr)	Cumulative Fraction	Time (hr)	Cumulative Fraction	Time (hr)	Cumulative Fraction	Time (hr)	Cumulative Fraction
0.1	0.00189	4.6	0.10808	9.1	0.25631	13.6	0.68341	18.1	0.85354	22.6	0.97168
0.2	0.0038	4.7	0.11091	9.2	0.26074	13.7	0.68825	18.2	0.85661	22.7	0.97384
0.3	0.00573	4.8	0.11376	9.3	0.2652	13.8	0.69307	18.3	0.85967	22.8	0.97597
0.4	0.00768	4.9	0.11663	9.4	0.2697	13.9	0.69784	18.4	0.8627	22.9	0.97809
0.5	0.00965	5	0.11952	9.5	0.27423	14	0.70258	18.5	0.86571	23	0.98018
0.6	0.01165	5.1	0.12244	9.6	0.2788	14.1	0.70729	18.6	0.86871	23.1	0.98226
0.7	0.01366	5.2	0.12537	9.7	0.2834	14.2	0.71196	18.7	0.87168	23.2	0.98431
0.8	0.01569	5.3	0.12832	9.8	0.28804	14.3	0.7166	18.8	0.87463	23.3	0.98634
0.9	0.01774	5.4	0.13129	9.9	0.29271	14.4	0.7212	18.9	0.87756	23.4	0.98835
1	0.01982	5.5	0.13429	10	0.29742	14.5	0.72577	19	0.88048	23.5	0.99035
1.1	0.02191	5.6	0.1373	10.1	0.30216	14.6	0.7303	19.1	0.88337	23.6	0.99232
1.2	0.02403	5.7	0.14033	10.2	0.30693	14.7	0.7348	19.2	0.88624	23.7	0.99427
1.3	0.02616	5.8	0.14339	10.3	0.31175	14.8	0.73926	19.3	0.88909	23.8	0.9962
1.4	0.02832	5.9	0.14646	10.4	0.31659	14.9	0.74369	19.4	0.89192	23.9	0.99811
1.5	0.03049	6	0.14956	10.5	0.32148	15	0.74808	19.5	0.89473	24	1
1.6	0.03269	6.1	0.15267	10.6	0.32728	15.1	0.75179	19.6	0.89752		
1.7	0.03491	6.2	0.15581	10.7	0.33334	15.2	0.75547	19.7	0.90028		
1.8	0.03714	6.3	0.15897	10.8	0.33964	15.3	0.75914	19.8	0.90303		
1.9	0.0394	6.4	0.16214	10.9	0.34619	15.4	0.76279	19.9	0.90576		
2	0.04168	6.5	0.16534	11	0.35298	15.5	0.76642	20	0.90847		
2.1	0.04398	6.6	0.16856	11.1	0.36003	15.6	0.77002	20.1	0.91115		
2.2	0.0463	6.7	0.1718	11.2	0.36732	15.7	0.77361	20.2	0.91382		
2.3	0.04864	6.8	0.17506	11.3	0.37486	15.8	0.77717	20.3	0.91647		
2.4	0.051	6.9	0.17834	11.4	0.38265	15.9	0.78072	20.4	0.91909		
2.5	0.05338	7	0.18164	11.5	0.39068	16	0.78424	20.5	0.9217		
2.6	0.05578	7.1	0.18496	11.6	0.40026	16.1	0.78775	20.6	0.92428		
2.7	0.0582	7.2	0.1883	11.7	0.41117	16.2	0.79123	20.7	0.92685		
2.8	0.06064	7.3	0.19166	11.8	0.42585	16.3	0.79469	20.8	0.92939		
2.9	0.0631	7.4	0.19504	11.9	0.44681	16.4	0.79814	20.9	0.93191		
3	0.06558	7.5	0.19844	12	0.48521	16.5	0.80156	21	0.93442		
3.1	0.06809	7.6	0.20186	12.1	0.55319	16.6	0.80496	21.1	0.9369		
3.2	0.07061	7.7	0.20531	12.2	0.57415	16.7	0.80834	21.2	0.93936		
3.3	0.07315	7.8	0.20877	12.3	0.58883	16.8	0.8117	21.3	0.9418		
3.4	0.07572	7.9	0.21225	12.4	0.59974	16.9	0.81504	21.4	0.94422		
3.5	0.0783	8	0.21576	12.5	0.60932	17	0.81836	21.5	0.94662		
3.6	0.08091	8.1	0.21928	12.6	0.61735	17.1	0.82166	21.6	0.949		
3.7	0.08353	8.2	0.22283	12.7	0.62514	17.2	0.82494	21.7	0.95136		
3.8	0.08618	8.3	0.22639	12.8	0.63268	17.3	0.8282	21.8	0.9537		
3.9	0.08885	8.4	0.22998	12.9	0.63997	17.4	0.83144	21.9	0.95602		
4	0.09153	8.5	0.23358	13	0.64702	17.5	0.83466	22	0.95832		
4.1	0.09424	8.6	0.23721	13.1	0.65381	17.6	0.83786	22.1	0.9606		
4.2	0.09697	8.7	0.24086	13.2	0.66036	17.7	0.84103	22.2	0.96286		
4.3	0.09972	8.8	0.24453	13.3	0.66666	17.8	0.84419	22.3	0.96509		
4.4	0.10248	8.9	0.24821	13.4	0.67272	17.9	0.84733	22.4	0.96731		
4.5	0.10527	9	0.25192	13.5	0.67852	18	0.85044	22.5	0.96951		

Girdwood 24-hour Rainfall Distribution in 6-minute (0.1 hour) increments

Time (hr)	Cumulative Fraction	Time (hr)	Cumulative Fraction	Time (hr)	Cumulative Fraction	Time (hr)	Cumulative Fraction	Time (hr)	Cumulative Fraction	Time (hr)	Cumulative Fraction
0.1	0.0038	4.6	0.17692	9.1	0.35448	13.6	0.59287	18.1	0.77225	22.6	0.94664
0.2	0.0076	4.7	0.18081	9.2	0.35851	13.7	0.59693	18.2	0.77617	22.7	0.95047
0.3	0.0114	4.8	0.18471	9.3	0.36255	13.8	0.601	18.3	0.78009	22.8	0.95429
0.4	0.0152	4.9	0.18861	9.4	0.36659	13.9	0.60506	18.4	0.78401	22.9	0.95811
0.5	0.01901	5	0.19252	9.5	0.37063	14	0.60912	18.5	0.78793	23	0.96193
0.6	0.02281	5.1	0.19642	9.6	0.37467	14.1	0.61318	18.6	0.79184	23.1	0.96575
0.7	0.02662	5.2	0.20033	9.7	0.37872	14.2	0.61723	18.7	0.79576	23.2	0.96956
0.8	0.03044	5.3	0.20424	9.8	0.38277	14.3	0.62128	18.8	0.79967	23.3	0.97338
0.9	0.03425	5.4	0.20816	9.9	0.38682	14.4	0.62533	18.9	0.80358	23.4	0.97719
1	0.03807	5.5	0.21207	10	0.39088	14.5	0.62937	19	0.80748	23.5	0.98099
1.1	0.04189	5.6	0.21599	10.1	0.39494	14.6	0.63341	19.1	0.81139	23.6	0.9848
1.2	0.04571	5.7	0.21991	10.2	0.399	14.7	0.63745	19.2	0.81529	23.7	0.9886
1.3	0.04953	5.8	0.22383	10.3	0.40307	14.8	0.64149	19.3	0.81919	23.8	0.9924
1.4	0.05336	5.9	0.22775	10.4	0.40713	14.9	0.64552	19.4	0.82308	23.9	0.9962
1.5	0.05718	6	0.23168	10.5	0.41121	15	0.64955	19.5	0.82698	24	1
1.6	0.06101	6.1	0.2356	10.6	0.41533	15.1	0.65354	19.6	0.83087		
1.7	0.06485	6.2	0.23953	10.7	0.41946	15.2	0.65753	19.7	0.83476		
1.8	0.06868	6.3	0.24347	10.8	0.4236	15.3	0.66151	19.8	0.83865		
1.9	0.07252	6.4	0.2474	10.9	0.42776	15.4	0.6655	19.9	0.84254		
2	0.07635	6.5	0.25134	11	0.43192	15.5	0.66948	20	0.84642		
2.1	0.08019	6.6	0.25527	11.1	0.4361	15.6	0.67346	20.1	0.8503		
2.2	0.08404	6.7	0.25922	11.2	0.44029	15.7	0.67744	20.2	0.85418		
2.3	0.08788	6.8	0.26316	11.3	0.44448	15.8	0.68141	20.3	0.85806		
2.4	0.09173	6.9	0.2671	11.4	0.44869	15.9	0.68539	20.4	0.86194		
2.5	0.09558	7	0.27105	11.5	0.45291	16	0.68936	20.5	0.86581		
2.6	0.09943	7.1	0.275	11.6	0.45729	16.1	0.69333	20.6	0.86968		
2.7	0.10328	7.2	0.27895	11.7	0.46171	16.2	0.69729	20.7	0.87355		
2.8	0.10714	7.3	0.28291	11.8	0.46771	16.3	0.70126	20.8	0.87742		
2.9	0.111	7.4	0.28686	11.9	0.47668	16.4	0.70522	20.9	0.88128		
3	0.11486	7.5	0.29082	12	0.49335	16.5	0.70918	21	0.88514		
3.1	0.11872	7.6	0.29478	12.1	0.52332	16.6	0.71314	21.1	0.889		
3.2	0.12258	7.7	0.29874	12.2	0.53229	16.7	0.71709	21.2	0.89286		
3.3	0.12645	7.8	0.30271	12.3	0.53829	16.8	0.72105	21.3	0.89672		
3.4	0.13032	7.9	0.30667	12.4	0.54271	16.9	0.725	21.4	0.90057		
3.5	0.13419	8	0.31064	12.5	0.54709	17	0.72895	21.5	0.90442		
3.6	0.13806	8.1	0.31461	12.6	0.55131	17.1	0.7329	21.6	0.90827		
3.7	0.14194	8.2	0.31859	12.7	0.55552	17.2	0.73684	21.7	0.91212		
3.8	0.14582	8.3	0.32256	12.8	0.55971	17.3	0.74079	21.8	0.91596		
3.9	0.1497	8.4	0.32654	12.9	0.5639	17.4	0.74473	21.9	0.91981		
4	0.15358	8.5	0.33052	13	0.56808	17.5	0.74866	22	0.92365		
4.1	0.15746	8.6	0.3345	13.1	0.57224	17.6	0.7526	22.1	0.92748		
4.2	0.16135	8.7	0.33849	13.2	0.5764	17.7	0.75653	22.2	0.93132		
4.3	0.16524	8.8	0.34247	13.3	0.58054	17.8	0.76047	22.3	0.93515		
4.4	0.16913	8.9	0.34646	13.4	0.58467	17.9	0.7644	22.4	0.93899		
4.5	0.17302	9	0.35045	13.5	0.58879	18	0.76832	22.5	0.94282		

MOA 2-year, 6-hour Design Storm
From: JMM Consulting Engineers Inc, 1991

Time (minutes)	Precipitation (inches)	Time (minutes)	Precipitation (inches)	Time (minutes)	Precipitation (inches)
5	0.004	125	0.007	245	0.007
10	0.004	130	0.007	250	0.006
15	0.004	135	0.007	255	0.006
20	0.004	140	0.008	260	0.006
25	0.004	145	0.008	265	0.006
30	0.005	150	0.009	270	0.006
35	0.005	155	0.009	275	0.006
40	0.005	160	0.010	280	0.005
45	0.005	165	0.011	285	0.005
50	0.005	170	0.013	290	0.005
55	0.005	175	0.015	295	0.005
60	0.005	180	0.062	300	0.005
65	0.005	185	0.016	305	0.005
70	0.005	190	0.015	310	0.005
75	0.005	195	0.014	315	0.005
80	0.005	200	0.011	320	0.005
85	0.005	205	0.010	325	0.005
90	0.006	210	0.009	330	0.005
95	0.006	215	0.009	335	0.005
100	0.006	220	0.008	340	0.004
105	0.006	225	0.008	345	0.004
110	0.006	230	0.007	350	0.004
115	0.006	235	0.007	355	0.004
120	0.007	240	0.007	360	0.004
Total volume: 0.53 inches					

MOA Snow Melt Hyetographs

Model Event (March 10, 1969)		5-Year Recurrence (March 23, 1974)	
Time (hours)	Snow melt (inches) *	Time (hours)	Snow melt (inches)*
1	.02	1	.01
2	.02	2	.02
3	.02	3	.02
4	.02	4	.02
5	.02	5	.02
6	.02	6	.02
7	.03	7	.03
8	.03	8	.03
9	.03	9	.03
10	.02	10	.02
11	.02	11	.02
12	.02	12	.01
13	.01	13	.01
14	.00	14	.02
15	.00	15	.01
16	.01	16	.01
17	.01	17	.01
18	.01	18	.00
19	.00	19	.00
20	.00	20	.00
		21	.00
		22	.00
		23	.00
		24	.01
		25	.03
		26	.04
		27	.05
		28	.04
		29	.04
		30	.05
		31	.06
		32	.06
		33	.06
		34	.05
		35	.04
		36	.03
		37	.02
		38	.01
		39	.00
		40	.00
* Inches of water			

Appendix E: Plant List

Intentionally Left Blank

Plant List

	Filter Zones (Dry)	Intermittent Zones (Intermittent soil saturation)	Pool Margins (Permanent soil saturation)	Pool Zones (Deep water)
Trees	<i>Picea glauca</i>	<i>Populus trichocarpa</i>	<i>B. pumila</i>	
	White Spruce	Black cottonwood	Bog Birch	
	<i>Picea mariana</i>	<i>Picea mariana</i>	<i>Potentilla palustris</i>	
	Black spruce	Black spruce	Bog Cinquefoil	
	<i>Betula papyrifera</i>			
	Paper birch			
	<i>Betula neoalaskana</i>			
	Alaska paper birch			
	<i>Populus balsamifera</i>			
	Balsam poplar			
	<i>Populus tremuloides</i>			
	Quaking aspen			
	<i>Larix russica</i>			
	Siberian larch			
<i>Pinus sylvestris</i>				
Scotch pine				
Shrubs	<i>Salix bebbiana</i> *	<i>Dasiphora fruticosa</i>	<i>Myrica gale</i>	
	Bebb willow	Shrubby cinquefoil	sweet Gale	
	<i>Salix scouleriana</i> *	<i>Cornus sericea</i>	<i>Cornus sericea</i>	
	Scouler willow	Red-osier dogwood	Red-osier dogwood	
	<i>Viburnum edule</i>	<i>Cornus sericea</i>	<i>Cornus sericea</i>	
	Highbush cranberry	'flaviramea' Yellow-twig dogwood	'flaviramea' Yellow-twig dogwood	
	<i>Aronia melanocarpa</i>	<i>Salix lasiandra</i> *	<i>Ledum groenladicum</i>	
	Black chokeberry	Pacific willow	Labrador tea	
	<i>Juniperus communis</i>	<i>Betula glandulosa</i>		
	Common juniper	Shrub birch		
	<i>Juiperus horizontalis</i>	<i>Betula nana</i>		
	Creeping juniper	Dwarf birch		
	<i>Amelanchier alnifolia</i>	<i>Ledum groenladicum</i>		
	Serviceberry	Labrador tea		
	<i>Arctostaphylos uva- ursi</i>	<i>Luetkea pectinata</i>		
	Kinnikinnik	Alaska spirea		
	<i>Cornus canadensis</i>	<i>Luetkea stevenii</i>		
	Bunchberry dogwood	Steven spirea		
	<i>Rosa acicularis</i>	<i>Sorbus scopulina</i>		
	Wild rose	Green mountain ash		
Grasses	<i>Calamagrostis canadensis</i>	<i>Calamagrostis canadensis</i>	<i>Glyceria maxima</i>	<i>Glyceria Striata</i>
	Bluejoint reedgrass	Bluejoint reedgrass	Reed manna grass	Fowl manna grass
	<i>Elymus macrourus</i>	<i>Elymus macrourus</i>	<i>Beckmannia syzigachne</i>	
	Tufted wheatgrass	Tufted wheatgrass	Egan sloughgrass	
	<i>Festuca rubra</i> *	<i>Festuca rubra</i> *		
	Red fescue	Red fescue		
	<i>Deschampsia cespitosa</i>	<i>Deschampsia cespitosa</i>		
	Tufted hairgrass	Tufted hairgrass		

	Filter Zones (Dry)	Intermittent Zones (Intermittent soil saturation)	Pool Margins (Permanent soil saturation)	Pool Zones (Deep water)
	<i>Poa eminens</i>	<i>Poa eminens</i>		
Grass-likes		<i>Carex lyngbyei</i>	<i>Juncus tenuis</i> Slender rush	<i>Carex gmelinii</i> Gmelin’s sedge
			<i>Juncus ensifolius</i> Three stamen rush	<i>Eleocharis quadrangulata</i> Square-stemmed spike Rush
			<i>Carex lyngbyei</i>	<i>Juncus effuses</i> Soft rush
				<i>Eleocharis palustris</i> Creeping spikerush
				<i>Scirpus microcapus</i> Small fruit bullrush
			<i>Scirpus validus</i> Softstem bullrush	
			<i>Eleocharis acicularis</i> Least spikerush	
			<i>Scirpus acutus</i> Hard-stemmed bullrush	
			<i>Scirpus americanus</i> Olney’s bulrush	
Aquatics		<i>Plantago maritima</i>	<i>Plantago maritima</i>	
				<i>Brasenia schreberi</i> Watershield
				<i>Triglochin maritimum</i> Seaside arrow grass
			<i>Ceratophyllum demersum</i> Common hornwort	
			<i>Zannichellia palustris</i> Horned pondweed	
			<i>Lemna minor</i> Lesser duckweed	<i>Zostera marina</i> Eel grass
			<i>Nymphaea tetragona</i> Pigmy water lily	<i>Potamogeton natans</i> Floating leaf pondweed
			<i>Oenanthe sarmentosa</i> Water parsley	<i>Potamogeton pectinatus</i> Sago pondweed
			<i>Potamogeton foliosus</i> Leafy pondweed	<i>Potamogeton pusillus</i> Small pondweed
			<i>Potamogeton gramineus</i> Grassy pondweed	<i>Potamogeton zosteriformis</i> Flat-stemmed pondweed
			<i>Typha latifolia*</i> Broad-leaf cattail	<i>Ruppia maritima</i> Widgeon-grass
Wildflowers	<i>Corydalis sempervirens</i> Golden corydalis	<i>Dodecatheon sp.</i> Shooting star	<i>Dodecatheon sp.</i> Shooting star	<i>Hippuris tetraphylla</i>
	<i>Aquilegia sp.</i> Columbine	<i>Aconitum delphinifolium</i> Monkshood	<i>Geranium erianthum</i> Wild geranium	
	<i>Polemonium pulcherrimum</i> Beautiful Jacob’s ladder	<i>Geranium erianthum</i> Wild geranium	<i>Fritillaria camschatcensis</i> Chocolate lily	
		<i>Oplopanax horridus</i> Devil’s club	<i>Dryopteris expansa</i> Shield fern	
		<i>Aquilegia sp.</i> Columbine	<i>Iris setosa</i> Wild iris	

Filter Zones (Dry)	Intermittent Zones (Intermittent soil saturation)	Pool Margins (Permanent soil saturation)	Pool Zones (Deep water)
	<i>Aruncus dioicus</i> Goat's beard	<i>Iris pseudacorus</i> Paleyellow iris	
	<i>Athyrium filix-femina</i> Lady fern	<i>Mertensia paniculata</i> Tall bluebells	
	<i>Corydalis sempervirens</i> Golden corydalis	<i>Hippuris tetraphylla</i>	
	<i>Fritillaria camschatcensis</i> Chocolate lily		
	<i>Dryopteris expansa</i> Shield fern		
	<i>Hemerocallis sp.</i> Daylily		
	<i>Iris setosa</i> Wild iris		
	<i>Matteuccia struthiopteris</i> Ostrich fern		
	<i>Mertensia paniculata</i> Tall bluebells		
	<i>Myosotis alpestris</i> Forget-me-knot		
	<i>Polemonium acutiflorum</i> Tall jacob's ladder		
	<i>Thalictrum sp.</i> Meadow rue		
	<i>Trollius sp.</i> Globeflower		
	<i>Filipendula sp.</i> Meadowsweet		
	<i>Aster sibiricus</i> Siberian aster		

This list is an example of plant species suitable for use in constructed stormwater treatment facilities. This is not a comprehensive list, and facility designers should develop a planting regime that incorporates a wide range of species based on individual site characteristics and plant availability. The use of additional plants outside of this list are encouraged, provided the selected plants are native/non-invasive and are appropriate for the design soil condition.

* - Hyperaccumulators: Plants known in Alaska to be capable of accumulating or tolerating contaminants at greater levels than common nonaccumulator plants.

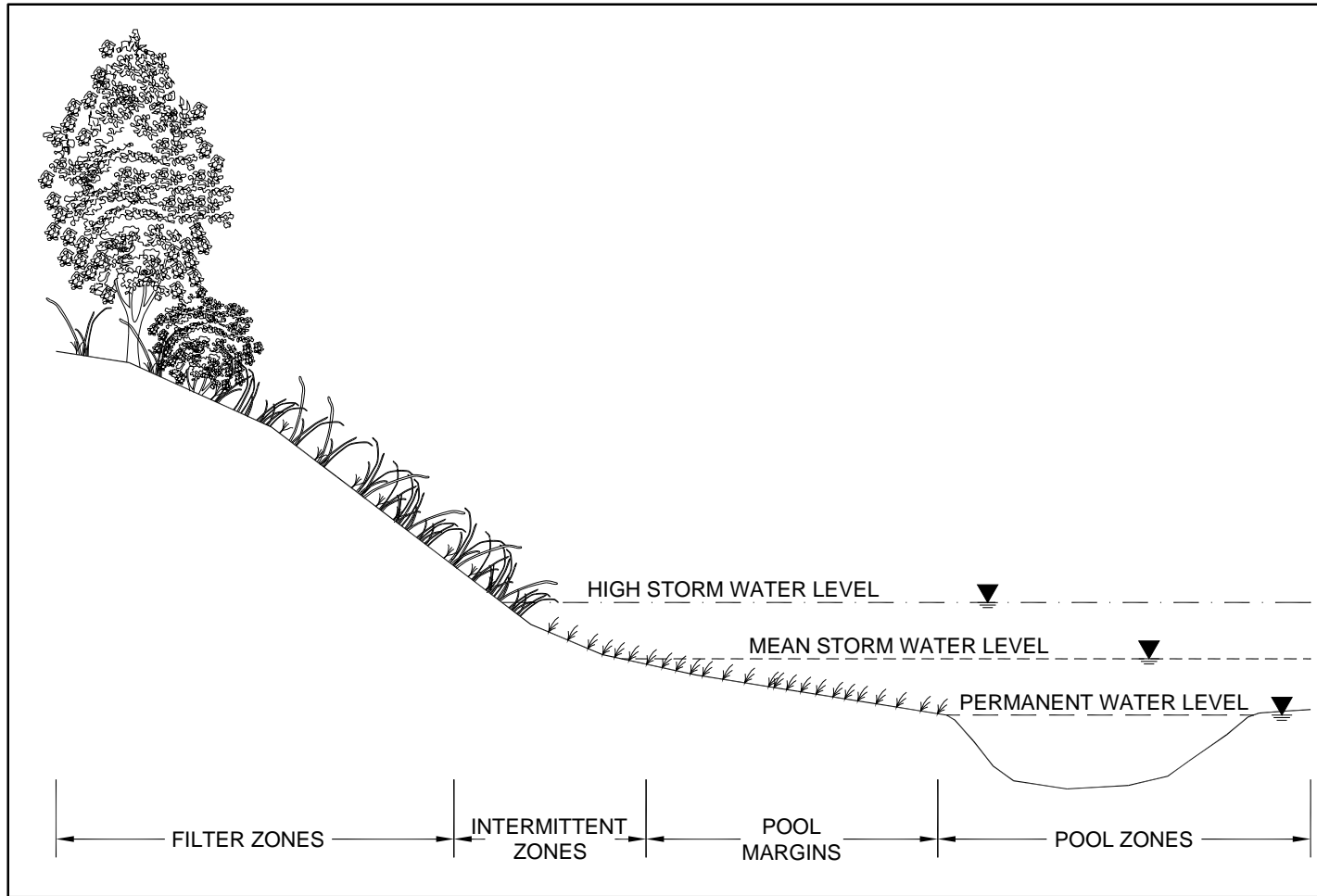

Figure 1: Planting Zones

Appendix F:

Class V Injection Well Memorandum

Intentionally Left Blank



UNITED STATES ENVIRONMENTAL PROTECTION AGENCY
WASHINGTON, D.C. 20460

JUN 13 2008

OFFICE OF
WATER

MEMORANDUM

SUBJECT: Clarification on which stormwater infiltration practices/technologies have the potential to be regulated as "Class V" wells by the Underground Injection Control Program

TO: Water Division Directors, Regions 1-10

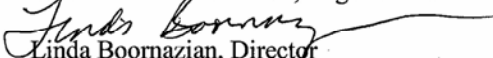
FROM: 
Linda Boornazian, Director
Water Permits Division (MC 4203M)

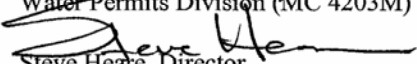
Steve Heate, Director
Drinking Water Protection Division (MC 4606M)

Over the past several years stormwater infiltration has become an increasingly effective tool in the management of stormwater runoff. Although primary stormwater management responsibilities within EPA fall under the Clean Water Act (CWA), the infiltration of stormwater is, in some cases, regulated under the Safe Drinking Water Act (SDWA) with the goal of protecting underground sources of drinking water (USDWs). Surface and ground water protection requires effective integration between the overlapping programs. This memorandum is a step forward in that effort and is meant to provide clarification on stormwater implementation and green infrastructure, in particular under the CWA, which is consistent with the requirements of the SDWA's Underground Injection Control (UIC) Program.

In April 2007, EPA entered into a collaborative partnership with four national groups (the Association of State and Interstate Water Pollution Control Administrators, the Low Impact Development Center, the National Association of Clean Water Agencies, and the Natural Resources Defense Council) to promote green infrastructure as a cost-effective, sustainable, and environmentally friendly approach to stormwater management. The primary goals of this collaborative effort are to reduce runoff volumes and sewer overflow events through the use of green infrastructure wet weather management practices.

Within the context of this collaborative partnership, green infrastructure includes a suite of management practices that use soils and vegetation for infiltration, treatment, and evapotranspiration of stormwater. Rain gardens, vegetated swales, riparian buffers and porous pavements are all common examples of green infrastructure techniques that capture and treat stormwater runoff close to its source. Green infrastructure management practices typically do not include commercially manufactured or proprietary infiltration

Internet Address (URL) • <http://www.epa.gov>

Recycled/Recyclable • Printed with Vegetable Oil Based Inks on Recycled Paper (Minimum 30% Postconsumer)

devices or other infiltration practices such as simple drywells, which do not provide for pre-treatment prior to infiltration.

The partnership is promoting green infrastructure as an effective approach to stormwater management because these practices are associated with a number of environmental benefits. In addition to reducing and delaying runoff volumes, green infrastructure approaches can also reduce pollutant levels in stormwater, enhance ground water recharge, protect surface water from stormwater runoff, increase carbon sequestration, mitigate urban heat islands, and increase wildlife habitat.

Given the multiple benefits that green infrastructure can provide, EPA and its partners have increased efforts to incorporate green infrastructure techniques into stormwater management strategies nationwide. In recent years, public support for these practices has gradually increased. For more information on green infrastructure, please visit www.epa.gov/npdes/greeninfrastructure.

There are cases where stormwater infiltration practices are regulated as Class V wells under the UIC program, and State and local stormwater managers report that some developers are hesitant to incorporate green infrastructure practices because they fear regulatory approvals will slow the process and increase costs. EPA believes those fears are unfounded and notes that most green infrastructure practices do not meet the Class V well definition and can be installed without regulatory oversight by the UIC Program. However, EPA remains committed to the protection of USDWs and emphasizes the need for UIC program compliance (per 40 CFR 144).

To provide clarification on which stormwater infiltration techniques meet EPA's UIC Class V well definition, EPA's Office of Water has developed the attached "Class V Well Identification Guide." State or Regional stormwater and nonpoint source control programs, developers, and other interested parties are requested to contact the State or Regional UIC Program Director with primary authority for the UIC Class V program when considering the use of practices that have been identified, or potentially identified, as Class V wells. UIC program managers should consider the proximity to sensitive ground water areas when looking at the suitability of stormwater infiltration practices. Depending on local conditions, infiltration without pretreatment may not be appropriate in areas where ground waters are a source of drinking water or other areas identified by federal, state, or local governments as sensitive ground water areas, such as aquifers overlain with thin, porous soils.

Please share this memo and the attached guide with your State and Regional stormwater, nonpoint source control, UIC and other ground water managers, as well as with appropriate green infrastructure contacts. These programs are encouraged to coordinate on stormwater management efforts when sensitive ground water issues arise.

Attachment

Underground Injection Control (UIC) Program Class V Well Identification Guide

This reference guide can be used to determine which stormwater infiltration practices/technologies have the potential to be regulated as “Class V” wells. Class V wells are wells that are not included in Classes I through IV. Typically, Class V wells are shallow wells used to place a variety of fluids directly below the land surface. By definition, a well is “any bored, drilled, driven shaft, or dug hole that is deeper than its widest surface dimension, or an improved sinkhole, or a subsurface fluid distribution system” and an “injection well” is a “well” into which “fluids” are being injected (40 CFR §144.3). Federal regulations (40 CFR §144.83) require all owners/operators of Class V wells to submit information to the appropriate regulatory authorities including the following:

1. Facility name and location
2. Name and address of legal contact
3. Ownership of property
4. Nature and type of injection well(s)
5. Operating status of injection well(s)

For more information on Class V well requirements, please visit http://www.epa.gov/safewater/uic/class5/comply_minrequirements.html. For more information on green infrastructure, please visit <http://www.epa.gov/npdes/greeninfrastructure>.

The stormwater infiltration practices/technologies in rows A through I below are generally not considered to be wells as defined in 40 CFR §144.3 because typically they are not subsurface fluid distribution systems or holes deeper than their widest surface dimensions. If these practices/technologies are designed in an atypical manner to include subsurface fluid distribution systems and/or holes deeper than their widest surface dimensions, then they may be subject to the Class V UIC regulations. The stormwater infiltration practices/technologies in rows J through K however, depending upon their design and construction probably would be subject to UIC regulations.

Infiltration Practice/Technology	Description	Is this Practice/Technology Generally Considered a Class V Well?
Trees & Planter Boxes	Tree boxes and planter boxes are generally found in the right-of-ways alongside city streets. These areas provide permeable areas where stormwater can infiltrate. The sizes of these boxes can vary considerably.	No.
Permeable Pavement	Permeable pavement is a porous or pervious pavement surface, often built with an underlying stone reservoir that temporarily stores surface runoff before it infiltrates into the subsoil. Permeable pavement is an environmentally preferable alternative to traditional pavement that allows stormwater to infiltrate into the subsoil. There are various types of permeable surfaces, including permeable asphalt, permeable concrete and even grass or permeable pavers.	No.
Reforestation	Reforestation can be used throughout a community to reestablish forested cover on a cleared site, establish a forested buffer to filter pollutants and reduce flood hazards along stream corridors, provide shade and improve aesthetics in neighborhoods or parks, and improve the appearance and pedestrian comfort along roadsides and in parking lots.	No.
Downspout Disconnection	A practice where downspouts are redirected from sewer inlets to permeable surfaces where runoff can infiltrate.	In certain circumstances, for example, when downspout runoff is directed towards vegetated/pervious areas or is captured in cisterns or rain-barrels for reuse, these practices generally would not be considered Class V wells.
Infiltration Trenches	An infiltration trench is a rock-filled trench designed to receive and infiltrate stormwater runoff. Runoff may or may not pass through one or more pretreatment measures, such as a swale, prior to entering the trench. Within the trench, runoff is stored in the void space between the stones and gradually infiltrates into the soil matrix. There are a	In certain circumstances, for example, if an infiltration trench is “deeper than its widest surface dimension,” or includes an assemblage of perforated pipes, drain tiles, or other similar mechanisms

	Infiltration Practice/Technology	Description	Is this Practice/Technology Generally Considered a Class V Well?
K	Commercially Manufactured Stormwater Infiltration Devices	Includes a variety of pre-cast or pre-built proprietary subsurface detention vaults, chambers or other devices designed to capture and infiltrate stormwater runoff.	These devices are generally considered Class V wells since their designs often meet the Class V definition of subsurface fluid distribution system.
L	Drywells, Seepage Pits, Improved Sinkholes.	Includes any bored, drilled, driven, or dug shaft or naturally occurring hole where stormwater is infiltrated.	These devices are generally considered Class V wells if stormwater is directed to any bored, drilled, driven shaft, or dug hole that is deeper than its widest surface dimension, or has a subsurface fluid distribution system.

Intentionally Left Blank

Appendix G:

Infiltration Testing Methods and Frequency

Intentionally Left Blank

Infiltration Testing Methods and Frequency

The minimum testing schedule shall be as shown in the Table below.

Testing Schedule for Infiltration Controls

Infiltration Facility Type	Applicable Test Method	Test Frequency
Surface Facilities (filter strip, vegetative swale, and pervious pavement)	<ul style="list-style-type: none"> • Soil Boring w/ Cased Infiltration OR	1 per 10,000 square feet
Subsurface and Basin Facilities (soakaway pit, infiltration trench, bioretention, and chamber system, infiltration basin, constructed wetland, wet pond, and dry pond)	<ul style="list-style-type: none"> • Test Pit w/Falling Head Percolation OR • ASTM D3385 All facilities require installation of a minimum of one piezometer.	For Bottom-controlled infiltration – 1 per 500 square feet For sidewall controlled—1 per 50 linear feet

Initial testing is conducted to provide design feasibility information, and is intended to determine the suitability of a site for installation of various structural stormwater control. Testing shall be performed and submitted as part of the Watershed Management Report. Testing frequency shall be either one field test per facility, regardless of type or size, or shall be conducted in accordance with the testing facility above, whichever is greater. Testing shall be performed at the location of the proposed stormwater control.

Bottom controlled facilities are facilities whose primary infiltration area is considered to be the bottom of the facility (e.g. an infiltration basin). Sidewall controlled facilities are those facilities whose primary infiltration area is considered to be the sidewalls of the facility (e.g. an infiltration trench). Where both cases apply, the more stringent test frequency shall apply.

Soil test borings or test pits shall be advanced a minimum of four feet below the design base of the control and logs of soil strata recorded from the ground surface to the bottom of boring. Test pits may be used instead of borings to collect soil samples but conditions described in following text must still be met for installing piezometers or performing percolation tests. Soil samples shall be collected and laboratory tests for grain size analysis performed of soil samples collected at the base and four feet below the base of the proposed control. Soil sampling and laboratory testing shall be sufficient to determine particle size characteristics (Unified Soil Classification System—ASTM D2487) of representative natural sediments at the base and four feet beneath the base of the proposed control.

A capped piezometer, perforated from the base to four feet below the base of the proposed control and sealed at the ground surface to prevent surface water from entering along the outer casing wall, shall be placed in at least one boring location per control so as to allow measurement of seasonal variation in the shallow groundwater surface at the site.

At least three measurements of the shallow ground water surface shall be obtained from each piezometer between August 1 and October 31 and results reported in terms of depth from ground surface to surface of water in the piezometer.

Infiltration tests and piezometers shall be conducted in a portion of the pit where natural soils are left undisturbed below the proposed base of the structure for a distance of at least 10 feet in diameter from any infiltration and piezometer testing locations. Where piezometers are to be installed in test pits, piezometers shall be placed adjacent to the undisturbed portion of the pit and carefully backfilled to avoid damage. Cased borings may also be used to test infiltration or tests may be done using standard or modified standard ASTM D3385 double-ring infiltration tests performed on the undisturbed pit bottom.

Infiltration tests shall be performed at the location and at the base of the proposed infiltration control. All infiltration testing shall be performed in accordance with the method schedule shown in the table above. The standard method for infiltration testing for surface and basin controls shall be ASTM D3385, 'Standard Test Method for Infiltration Rate of Soils in Field Using Double-Ring Infiltrometer'. The method may be modified to use reduced ring diameters (2.5 and 4.25 inch inner and outer ring dimensions respectively) through application of the IN2-W Turf-Tec Infiltrometer or equal (USEPA 1999).

Trenches or other deep-excavation infiltration controls, may be tested for infiltration using falling head percolation methods modified from EPA (USEPA, 1980). Methods as described in the EPA guidance shall be applied except that in all cases test borings shall be extended a minimum of one foot and a maximum of two feet below the base of the control; non-perforated casing shall be placed so that the bottom of the casing is at the boring bottom; and the annular space between the casing and hole walls completely backfilled and compacted with hole cuttings. The boring shall not be greater than approximately twice the diameter of the casing used in the test. Use of perforated casing shall not be allowed in performing falling head percolation tests. Sorted, washed gravel may be placed at the base of the boring below the bottom of the test casing to minimize hole erosion as water is introduced into the casing, but the total thickness of the placed gravel shall not exceed four inches.

All testing shall be documented in a summary report including: complete description of work history and methods; maps of boring and test locations in relation to proposed controls and project boundaries; tabulation of collected data; calculations and results including laboratory reports and field test results; and graphic logs of all soil borings and test holes showing boring and test installation dimensions, significant strata changes (including any fill) with associated engineering soils descriptions and depths, sample locations and identities related to laboratory tests, and water table (with time and date) and bedrock depths. All vertical measurements shall be reported relative to the undisturbed ground surface.

Appendix H:

Additional Specifications for Bioretention Soils

Intentionally Left Blank

Additional Guidance Engineered Soils

Note: The following guidance for specifying an engineered soil for a bioretention system has been adapted from the Puget Sound Action Team, Low Impact Development Technical Guidance Manual for Puget Sound.

The following bulleted list is intended to assist designers in specifying an engineered soil mix for use in a bioretention system. Soil specifications may vary slightly depending on site characteristics and related design considerations.

- The final soil mix (including compost and soil) should have a long-term hydraulic conductivity of approximately 1.0 inch/hour according to ASTM Designation D 2434 (Standard Test Method for Permeability of Granular Soils) at 80% compaction per ASTM Designation D 1557 (Standard Test Methods for Laboratory Compaction Characteristics of Soil Using Modified Effort). Note that infiltration rate and hydraulic conductivity are assumed to be approximately the same in a uniform mix soil.
- The final soil mixture should have a minimum organic content of 10% by dry weight per ASTM Designation D 2974 (Standard Test Method for Moisture, Ash and Organic Matter of Peat and Other Organic Soils).
- The final soil mixture should be tested by an independent laboratory prior to installation for fertility, micronutrient analysis, and organic material content. Soil amendments per laboratory recommendations (if any) should be uniformly incorporated for optimum plant establishment and early growth.
- The clay content of the final soil mix should be less than 5%.
- The pH for the soil mix should be between 5.5 and 7.0. If the pH falls outside of the acceptable range, it may be modified with lime to increase the pH or iron sulfate plus sulfur to lower the pH. The lime or iron sulfate must be mixed uniformly into the soil prior to use in the bioretention system.
- Soil mix should be uniform and free of stones, stumps, roots, or other similar material greater than 2 inches in diameter.

Unless laboratory analysis indicates otherwise, engineered soils are to be assigned a design infiltration rate of 1.0 inch/hour during design efforts. This value is consistent with a moderately high saturated hydraulic conductivity.

Intentionally Left Blank

Appendix I:

Private Snow Disposal Sites White Paper

Intentionally Left Blank

Private Snow Disposal Sites (On-Site Snow Storage Only)

DRAFT Operations Guidance

Prepared by Scott R Wheaton, MOA Watershed Management Services

Winter 2003

In the United States, about 100 million tons of sand and 10 million tons of salt are applied to roads annually, and similar practices are commonly used on private parking lots. When snow is removed from these surfaces during plowing and snow disposal operations, part of the sand and salt applications are also removed, along with additional pollutants released by traffic. When the snow melts and discharges from snow stored at the snow disposal sites, some of these pollutants are carried away with the melt water. In addition to chloride and sediment pollutants, the high salt content of the melt water can also increase mobilization of the more toxic form of certain metals. Unchecked, these pollutants can clog drainages, damage pavements, promote noxious growths, kill or stunt ornamental and natural vegetation, contaminate surface and ground water supplies, and reduce important and valuable fish stocks.

Fortunately, a growing understanding of snow melt water processes provides operators with valuable insight into practicable methods that can be used to economically control pollutants released from snow disposal sites, both public and private. In both Canada and the United States, much new research has been directed at street deicing and snow disposal practices and their effects on the environment. Locally the Municipality of Anchorage has also focused its attention on these issues and has made progress in understanding and improving winter street maintenance and snow disposal practices. Private (on-site snow storage only) and commercial (off-site snow storage) snow disposal operations can benefit from these hard-won lessons. “Best management practices” taken as a whole are not only an optimal way to prevent environmental impacts but are also often the most beneficial approach from a business cost perspective as well. The following discussion summarizes best management practices for private (on-site snow storage only) snow disposal.

Municipal operators have discovered that the most cost-effective “best practices” include approaches that are applied at both the source of the plowed snow and at the disposal site. Like their municipal counterparts, operators responsible for plowing and on-site storage of snow from private parking lots and driveways are frequently responsible for application of winter surface treatments as well. Careful maintenance practices, including timing and types of salt and sand applications, will greatly reduce the ultimate pollutant load hauled to the snow disposal site—and reduce operation costs as well. After all, if you are plowing up salt and sand (that you have applied at great expense), it’s no longer helping improve traction across your client’s driveway or parking lot. Similarly, control of discharges of sediment and pollutants from a private snow storage site to the Municipal storm drain system is the responsibility of the site owner and operator. Up-front and practicable control of these pollutants, then, saves money and avoids fines and costly cleanup.

Though little specific information is available for privately operated on-site snow disposal operations, the pollutant sources and physical processes are similar to those that have become well documented for

Municipal and commercial sites. Operational guidance for private sites can be generally based on the current understanding of the pollutants and processes observed at these larger sites. Private operators will have to adjust actual practices to reflect the specific characteristics of different operational needs, snow sources and disposal sites, but the following practices are generally applicable.

- **Use Best Deicing Materials**

Buying the cheapest product is not always the least expensive practice, as each of us knows from experience in everyday life. The same is true in winter maintenance of parking lots and driveways. More is not always better and the cheapest is not always the least expensive: applying “smart” is the key. Consider the following uses:

Use magnesium chloride for small parking lots and sidewalks

Though it costs more, a molecule of magnesium chloride ($MgCl_2$) has two chloride ions and provides twice as much chloride as a molecule of sodium chloride ($NaCl$). Magnesium chloride is also effective at lower temperatures than sodium chloride. It is far less damaging to lawns and ornamentals (because magnesium replaces the sodium) and is less corrosive than sodium chloride, reducing capital and maintenance costs of landscaping, pavement and equipment. Conversely, the sodium ion (Na) in sodium chloride can not only kill landscape vegetation outright, but can also permanently ruin the soil.

Use coarser aggregate for “sanding”

Use of a coarser aggregate to improve winter traction on parking lots and sidewalks will reduce loss of effectiveness due to burial with continued snowfall or displacement by traffic (thus reducing need for re-application) and requires smaller additions of “antifreeze” salt to keep it free-flowing during application. It is also easier to spread uniformly. All these factors can greatly reduce total sand volumes required to achieve a similar effect (the Municipality has reduced total sand use by almost half since changing to a coarser sand specification).

- **Use Best Winter Maintenance Practices**

When and how you apply deicers to remove or loosen ice from sidewalks and driveways makes a big difference in how well they work, how much you apply, and ultimately how much it costs you. Minimize those areas that you treat to keep snow-and ice-free, but for those areas that must be kept bare, consider these practices:

Lightly apply deicers just before or just as snow begins to fall

This will help prevent a bond forming between the ice and the surface, making it easier to later simply shovel or plow the ice from the surface.

Do not apply deicers during a snowfall

They may appear to work briefly immediately upon application, but with continued snowfall will rapidly dilute and refreeze to form an even icier surface, and will ultimately be removed during plowing.

Apply deicers to melt snow and ice at the end of the storm

Application will be most effective immediately after you have removed the last of the new fallen snow. This is because to work, salt deicers not only require some moisture (to dissolve the salt) but also some heat. The heat, which is what actually melts the snow (calcium chloride is an exception because it releases heat as it dissolves in an exothermic reaction), may come from warming ambient temperatures, the sun's heat, or traffic. Applying deicers at the end of a snow storm takes advantage of these processes. You will use less deicer and have greater effect because temperatures will still be warm from the retreating storm front and the deicer will maintain greater antifreeze potency as the snow and ice melts.

Sweep or shovel surfaces free of slush and melted snow as soon as possible

A given concentration of salt is effective down to a certain temperature—as temperatures fall following a storm, melted ice will refreeze, necessitating continuing ice removal expenses.

- **Locate On-Site Snow Disposal Sites Effectively**

Avoid storing snow at locations within areas served by potable ground water wells

Salt in snow melt water is highly mobile, and mobilization of other pollutants can be promoted by high salt content. The cost for mitigating effects on ground water wells from inappropriately located or operated snow disposal sites will greatly outweigh any savings in snow hauling costs.

Avoid storing snow adjacent to residential and commercial properties

Operations at snow disposal sites typically include “high-stacking” snow. Snow also includes some sediment, trash and debris that become more noticeable as seasonal melting progresses. Because both these conditions can be visual nuisances to the site's residential and commercial neighbors, visual separation from these land uses is preferred. Where sites are located adjacent to these land uses, incorporate trees and dense vegetation along the site perimeter to act as visual and noise buffers and maintain as low a snow storage profile as possible. A low stored snow profile not only minimizes visual impacts but also will reduce impacts (and treatment costs) from salt released in the melt water.

Avoid draining snow storage sites to small lakes or streams

Salt in melt water is very “conservative”—it does not react or adsorb to other materials and so is very mobile. The best means of treatment are through minimization of initial concentrations (control initial salt application), minimization of leaching during melting (minimize the depth of stored snow), and by dilution. Because salt in melt water from snow

disposal site is at times concentrated, small waterbodies may not provide sufficient dilution, resulting in impacts to the receiving waters.

- **Operate Snow Disposal Sites Effectively**

Minimize leaching of chloride and maximize melt water detention and infiltration

The first melt water occurring at a snow disposal site can have very high salt concentrations. As each drop of melt water seeps vertically through a snow pile, salt is leached from the entire column of snow through which the drop of water flows. Early in the melt process, when the snow mass has all its original salt content, this leaching can increase salt in the melt water to concentrations much greater than that of the original pile. Conversely, as melting progresses, and when much of the salt has already been leached, salt concentrations in the melt water can become much smaller than that of the original plowed snow. A lower stored snow profile (a thinner pile) reduces the amount of snow that a drop of melt water passes through and thus reduces leaching and the peak salt concentration. As a general practice, place the snow in piles having larger footprints and lower profiles (do not exceed pile depths of 20 feet) to minimize the effects of salt leaching.

Preventing the first melt water from flowing off-site right away (“detaining” it) provides an opportunity for early, salt-rich melt water to be diluted by later melt water that has progressively lower salt concentrations. Infiltration likewise helps prevent rapid mobilization of initial salt-rich melt water, and, in addition, traps sediment on-site. Promote these effects by using as snow storage sites those areas having non-paved surfaces where possible (but only where potable ground water resources will not be put at risk), and grade the surface to encourage shallow impoundment of melt water on-site. Where snow storage/disposal must take place on pavement, place the snow on the lowest point on the pavement surface, and, as possible, direct melt water so that it will be detained on adjacent or nearby (on-site) permeable surfaces before discharge.

Minimize mobilization of on-site sediments

Fine sediments are common contaminants in plowed snow and can be easily mobilized during melting. However, seasonal on-site snow melt in Anchorage is by nature a slow and hydraulically low-energy process and there are many opportunities for practicable on-site treatment for this pollutant. The following are the basic elements of a best management practices plan for this pollutant. Place the first plowed snow of the year at the lowest point on the site, filling upslope from the initial fill point throughout the rest of the winter season. Stack hauled snow in a compact mass to a uniform thickness, maintaining steep sides and a relatively broad base (do not pile snow to depths greater than 20 feet). Maintain a vegetated site surface where possible. Armor and protect all drainage channels crossing the site and treat melt water, particularly for turbidity and salt, prior to its exit off-site. Placement of hauled snow at the low point should encourage ponding around the melting snow mass and minimize the length of flow paths for melt water draining across the site. Because much of the sediment in melt water is generated by the collapsing snow mass, stacking the snow with

very steep sides minimizes the amount of snow surface area that is most subject to this type of erosion. Piling the snow in a compact mass to uniform depths across a broad base (low stored snow heights) can significantly help reduce leached chloride concentrations in the early melt water released from the stored snow. Vegetated site surfaces help trap fine sediments, metals, and petroleum pollutants. For this reason it is important to promote spring revegetation by limiting site access and otherwise preventing trafficking and disturbance of the wet ground surface.

Where snow disposal must take place on pavement, placing snow across as broad a footprint as possible, at uniform depths and at the low point on the site remains important. In these cases it even more important to minimize the drainage path from the melting snow mass to the nearest storm drain inlet or ground surface discharge point. Where melt water flow exits a paved surface onto ground, dissipate flow energy by directing flow across a rock or grass apron. In all cases, providing unobstructed, armored melt water channels is important to minimize erosion. Flag dedicated site drainage channels so that hauled snow is not accidentally placed in them, creating the potential for diverting flow to more erodible surfaces. Armor the main channels: depending on site grade and the volume of melt water, grass or very small aggregate may provide adequate armor. Where melt water is not adequately treated through detention, site layout and operational practices, further treatment in on-site sedimentation basins or oil and grit separators may be required.

Clean snow disposal sites at the end of the snow melt season

Plowing snow inevitably incorporates some trash and debris. During active snow melt this debris remains wet and relatively immobile. At the end of the melt season, remove trash and litter from the site, and perform maintenance on drainage channels and sediment traps. If it is necessary to regrade the site, complete re-grading early and limit summer access to promote revegetation. Sweep all paved surfaces as soon as they become free of snow and impounded water (do not sweep sediments into the impounded water) and clean any melt water pollutant treatment devices (e.g., oil/grit separators, sedimentation basins, etc.).

Intentionally Left Blank

Appendix J: Snow Disposal Site Seeding Specifications

Intentionally Left Blank

Snow Disposal Site Seeding Specifications

Section 1.0 SEEDING SNOW DISPOSAL SITES

Article 1.1 General

The work under this section shall consist of providing all labor, equipment, and materials for the preparation of ground surfaces for the application and maintenance of native grass seeded areas, fertilization, lime application (if necessary), watering and mulching at locations shown on the drawings or established by the Engineer.

All seeding shall be performed between May 1 and September 1. Seeding at other than the specified dates will only be allowed upon written approval from the Engineer. Seeding shall not be done during windy conditions or when climatic or ground conditions would hinder placement or proper germination of seed mixes.

Article 1.2

a. Seed

Seed shall conform to the following seed mix type and application rate.

Schedule A

Application rate: 4.5 lbs. /1,000 square feet

Name	Proportion by weight	Purity	Germination
<i>Festuca rubra</i>	40%	90%	85%
<i>Deschampsia caespitosa</i>	20%	90%	85%
<i>Leymus arenarius</i>	20%	90%	85%
<i>Beckmannia syzigachne</i>	20%	90%	85%

b. Fertilizer

Fertilizer shall be of a standard commercial type supplied separately or in mixtures and furnished in moisture-proof containers. Each container shall be marked with the weight and the manufacturer's guaranteed analysis of the contents showing the percentage for each ingredient contained therein. The proportion of chemical ingredients furnished shall be a mixture such as to provide the total available nitrogen, phosphoric, and potassium as required by the soil analysis or as specified in the Special Provisions.

c. Limestone

Limestone shall contain not less than 85 percent of calcium and magnesium carbonates. Agricultural ground limestone suitable for application by a fertilizer spreader shall conform to the following gradation:

<u>Sieve Designation</u>	<u>Minimum Percent Passing by weight</u>
No. 10	100
No. 20	90
No.100	50

Fertilizer and limestone for use in a hydraulic sprayer shall be soluble or round to a fineness that will permit complete suspension of insoluble particles in water.

Article 2.3 Application

a. Soil preparation

After grading of areas has been completed in conformity with the lines and grades shown on the Drawings, and before beginning seeding operations, the area to be seeded shall be cultivated to provide a reasonably firm but friable seedbed. Cultivation shall be carried to a depth of two inches. On slopes steeper than three horizontal to one vertical (3:1), depth of cultivation may be reduced as directed by the Engineer. All cultivated areas shall be raked or cleared of stones one inch in diameter and larger; all weeds, plant growth, sticks, stumps and other debris or irregularities which might interfere with the seeding operation, germination of seed, or subsequent maintenance of the seed cover areas shall be removed.

b. Fertilizer

Fertilizer shall be applied at a rate to provide 2 lbs. actual nitrogen per 1,000 square foot of area. In the absence of soil tests and the direction from the Engineer, the Contractor shall apply 16-16-16 at the rate of 12.5 lbs per 1,000 sf.

Article 2.4 Maintenance

The contractor shall protect seeded areas from damage from all traffic, whether people, animals, on or off-road vehicles, or any other causes that may damage newly seeded and maintained surfaces. Surfaces damaged shall be repaired by regrading, reseeding (including all specified amendments) as directed by the Engineer and at no additional cost to the Owner. The contractor shall otherwise maintain seed areas in a satisfactory condition until Final Acceptance of the work.

Appendix K: Daily Pollutant Buildup Ranges

Intentionally Left Blank

Daily Pollutant Build-Up Ranges

Land Use	BOD5 ¹ (lbs/Ac/Day)	SUS-SOL ² (lbs/Ac/Day)	SET-SOL ³ (lbs/Ac/Day)	TDS ⁴ (lbs/Ac/Day)	NH3 ⁵ (lbs/Ac/Day)	NO3 ⁶ (lbs/Ac/Day)	TOT-P ⁷ (lbs/Ac/Day)	GRS-OIL ⁸ (lbs/Ac/Day)	FE-COL ⁹ (BILLION MPN/Ac/Day)
Commercial	0.33-0.43	4.9-5.0	0.004-0.005	0.8-1.3	0.005-0.010	0.002-0.006	0.007-0.25	0.20-0.23	0.009-0.15
Industrial	0.35-0.60	7.5-7.5	0.0075-0.01	1.0-2.0	0.005-0.010	0.0005- 0.003	0.0053-0.10	0.30-0.34	0.002-0.01
Multiple-Family Residential	0.12-0.34	0.50-1.6	0.001-0.005	0.40-1.3	0.005-0.015	0.0012- 0.0015	0.0035-0.08	0.06-0.10	0.0008-0.007
High-Density Residential	0.10-0.49	0.20-1.0	0.003-0.004	0.3-0.8	0.002-0.016	0.001-0.002	0.002-0.15	0.03-0.04	0.002-0.002
Low-Density Residential	0.05-0.10	0.15-0.7	0.001-0.002	0.25-0.3	0.002-0.005	0.0005- 0.001	0.0014-0.02	0.01-0.02	0.001-0.0015
Cleared and Pervious	0.02-0.05	0.10-0.5	0.001-0.001	0.2-0.3	0.002- 0.0005	0.0001- 0.0005	0.0007-0.01	0.001-0.002	0.001-0.001
Bogs and Marshes	0.01-0.02	0.0-0.0	0.0-0.0	0.1-0.2	0.0001- 0.0002	0.0001- 0.0001	0.0007- 0.0007	0.0-0.0001	0.0001-0.001
Lowland Forest	0.01-0.01	0.0-0.0	0.0-0.0	0.1-0.1	0.0001- 0.0002	0.0001- 0.0001	0.0007- 0.0007	0.0-0.0001	0.0001-0.001
Upland Forest	0.01-0.01	0.0-0.0	0.0-0.0	0.1-0.1	0.0001- 0.0002	0.0001- 0.0001	0.0007- 0.0007	0.0-0.0001	0.0001-0.001
Natural Pervious	0.01-0.01	0.0-0.0	0.0-0.0	0.01-0.1	0.0001- 0.0002	0.0001- 0.0001	0.0007- 0.0007	0.0-0.0001	0.0001-0.001

(1) BOD5 – Biological Oxygen Demand (5) NH3 – Ammonia Nitrogen (9) FE-COL – Fecal Coliform

(2) SUS-SOL – Suspended Solids (6) NO3 – Nitrate Nitrogen

(3) SET-SOL – Settleable Solids (7) TOT-P – Total Phosphorus

(4) TDS – Total Dissolved Solids (8) GRS-OIL – Grease and Oil

Intentionally Left Blank

Appendix L:

Green Infrastructure Feasibility Forms

Intentionally Left Blank



**Roadway Project
Determination of Low Impact Development/Green Infrastructure
vs. Traditional Stormwater Treatment**

1. Project Name _____

2. Project Location _____

3. Project Owner _____

4. Project Contact Name _____ Phone _____ Email _____

5. Project Description/Purpose _____

6. Project Type

New Construction

Rehabilitation, re-construction, upgrade etc.

*Note that roadway resurfacing and certain types of maintenance projects are exempt from stormwater treatment requirements per Chapter 3 of the ASM Volume 1. Refer to Chapter 3 for additional information.

7. Describe the following site parameters. Attach soils logs, field testing results, and laboratory testing results, as applicable.

a. General Native Soil Condition

Gravels Sandy silt

Sandy gravels Silt

Gravely sands Clay/Silt

Sands Other (please describe) _____

Silty sand

b. Saturated Soil Percolation Rate (if field percolation testing was performed)

<0.5 inches/hour

0.5 to 1 inches/hour

1 to 3 inches/hour

4 to 8 inches/hour

>8 inches/hour

Testing has not been performed

c. Depth of groundwater table is _____ feet below finished ground surface on _____ (date).

d. Project ROW width after any ROW acquisition is completed _____

e. Total width of roadway improvements _____ Total thickness of structural section _____

f. Attach a sketch of the project's proposed typical section within the ROW. Include dimensions.



Roadway Project
Determination of Low Impact Development/Green Infrastructure
vs. Traditional Stormwater Treatment

8. Check all types of facilities that were considered, including facilities that may be a combination of one or more of these.

- | | |
|---|---|
| <input type="checkbox"/> Bioretention | <input type="checkbox"/> Pervious Pavement |
| <input type="checkbox"/> Chamber Systems | <input type="checkbox"/> Canopy Cover/Vegetation Retention |
| <input type="checkbox"/> Infiltration Basin | <input type="checkbox"/> Infiltration Basin |
| <input type="checkbox"/> Filter Strips | <input type="checkbox"/> Use of Landscaping for Stormwater Management |
| <input type="checkbox"/> Vegetated Swales | <input type="checkbox"/> Other (please list) _____ |
| <input type="checkbox"/> Soak-away Pits | |

9. Check all modifications that were considered.

- Addition of a sub-drain
- Addition of a bypass or overflow
- Application of the 20% area allowance? (See description in ASM Vol 1 Chapter 3, Section 3.2.2.1)
- Soil amendments
- Application of a different technique (e.g. filtration if infiltration is not feasible)
- Other (please list) _____

10. Provide a sketch that depicts the general site drainage. (Locations of drainage features, receiving systems, flow directions, etc.)

11. Provide a detailed explanation for why Green Infrastructure is not feasible for this project. Address the relevance of modifications. Use additional sheets and attach supporting information if needed.



**Roadway Project
Determination of Low Impact Development/Green Infrastructure
vs. Traditional Stormwater Treatment**

11. Continued
Signature _____ Signature of Project Engineer required. Project Engineer must be a registered Professional Civil or Environmental Engineer in the State of Alaska. Printed Name _____ Professional License Number _____ Name of Firm _____ Phone _____ Email _____
<i>For Municipal Use Only</i> Based on the above information, Low Impact Development/Green Infrastructure <input type="checkbox"/> is likely feasible and should be incorporated into this project. <input type="checkbox"/> Is likely not feasible and traditional treatment methods are allowable. <input type="checkbox"/> Additional Information is needed. Name _____ Date _____ Signature _____



Site Development
Low Impact Development/Green Infrastructure vs. Traditional Treatment Determination
or
Request for Alternative Compliance

<p>1. Project Name _____</p> <p>2. Project Location _____</p> <p>3. Project Owner: _____</p> <p>4. Project Contact Name _____ Phone _____ Email _____</p> <p>5. Project Description/Purpose _____</p> <p>_____</p>
<p>6. Request Type</p> <p><input type="checkbox"/> Approval of Traditional Stormwater Treatment</p> <p><input type="checkbox"/> Alternative Compliance Request</p>
<p>7. This project is</p> <p><input type="checkbox"/> New Development <input type="checkbox"/> Re-development</p>
<p>8. Describe the following site parameters. Attach soils logs, field testing results, and laboratory testing results, as applicable.</p> <p>a. General Native Soil Condition</p> <p><input type="checkbox"/> Gravels <input type="checkbox"/> Sandy silt</p> <p><input type="checkbox"/> Sandy gravels <input type="checkbox"/> Silt</p> <p><input type="checkbox"/> Gravelly sands <input type="checkbox"/> Clay/Silt</p> <p><input type="checkbox"/> Sands <input type="checkbox"/> Other (please describe) _____</p> <p><input type="checkbox"/> Silty sand</p> <p>b. Saturated Soil Percolation Rate (if field percolation testing was performed)</p> <p><input type="checkbox"/> <0.5 inches/hour</p> <p><input type="checkbox"/> 0.5 to 1 inches/hour</p> <p><input type="checkbox"/> 1 to 3 inches/hour</p> <p><input type="checkbox"/> 4 to 8 inches/hour</p> <p><input type="checkbox"/> >8 inches/hour</p> <p><input type="checkbox"/> Testing has not been performed</p> <p>c. Depth of groundwater table is _____ feet below finished ground surface on _____ (date).</p> <p>d. Site Area (Acres/SF) _____ Land Use Zoning Designation _____</p> <p>e. Area and description of impervious surfaces _____</p> <p>f. Average site slope: Existing _____ Proposed _____</p>



Site Development
Low Impact Development/Green Infrastructure vs. Traditional Treatment Determination
or
Request for Alternative Compliance

9. Check all types of facilities that were considered, including facilities that may be a combination of one or more of these.

<input type="checkbox"/> Bioretention <input type="checkbox"/> Chamber Systems <input type="checkbox"/> Infiltration Basin <input type="checkbox"/> Filter Strips <input type="checkbox"/> Vegetated Swales <input type="checkbox"/> Soak-away Pits	<input type="checkbox"/> Pervious Pavement <input type="checkbox"/> Canopy Cover/Vegetation Retention <input type="checkbox"/> Infiltration Basin <input type="checkbox"/> Use of Landscaping for Stormwater Management <input type="checkbox"/> Other (please list) _____
--	--

10. Check all modifications that were considered.

- Addition of a sub-drain
- Addition of a bypass or overflow
- Application of the 20% area allowance? (See description in ASM Vol 1 Chapter 3, Section 3.2.2.1)
- Soil amendments
- Application of a different technique (e.g. filtration if infiltration is not feasible)
- Other (please list) _____

11. Provide a sketch that depicts the general site drainage. (Locations of drainage features, receiving systems, flow directions, etc.

12. Are there conflicting MOA regulations that are preventing/inhibiting the use of Green Infrastructure? (For example, if adequate space is not available due to parking space requirements).

No Yes: Code or Regulation Reference _____

13. Provide an explanation for why LID/Green Infrastructure is not feasible for this project or describe the alternative compliance that is requested. When considering LID/GI feasibility, address the relevance of modifications. Use additional sheets and attach supporting information if needed.



Site Development
Low Impact Development/Green Infrastructure vs. Traditional Treatment Determination
or
Request for Alternative Compliance

13. Continued.
<p>Signature _____</p> <p>Signature of Project Engineer required. Project Engineer must be a registered Professional Civil or Environmental Engineer in the State of Alaska.</p> <p>Printed Name _____ Professional License Number _____</p> <p>Name of Firm _____ Phone _____ Email _____</p>
<p><i>For Municipal Use Only</i></p> <p>Based on the above information, the request for</p> <p><input type="checkbox"/> The use of Traditional Stormwater Treatment</p> <p><input type="checkbox"/> Alternative Compliance Request</p> <p>Is hereby</p> <p><input type="checkbox"/> Approved <input type="checkbox"/> Dis-approved <input type="checkbox"/> Additional Information Needed</p> <p>Name _____ Date _____</p> <p>Signature _____</p>

Appendix A:

Drainage Certification and WMS Mapping Forms

Intentionally Left Blank

Drainage Certification Form – Part A

Applicant Name		Contact Information (Phone and/or email)	
Mailing Address			
Property Description (subdivision, lot(s), and block)			
Plat Number		MOA Assessor's Office Property Identification Number	
MOA Tracking Number(s) Indicate which is provided)			
Project Category (Check one)	<input type="checkbox"/> Small <input type="checkbox"/> Medium (This form is not applicable to other project types. Small Projects are not required to submit Part B.)		
Project and/or Report Title			

By signature below, I certify that (initial all that apply):

_____ The project will disturb less than 10,000 square feet of land area. (Small project)

_____ The fractions of impervious, lawn or other landscaping, and naturally vegetated landcover types present at pre-development of the project will not change by more than 5% as a result of the proposed development. (Medium project)

_____ The entire project area does not exceed 0.75 acres. (Medium project)

_____ The project is a fill and grade permit for a residential single family home or duplex involving only one lot with less than 5,000 CY of fill material. (Medium project)

In addition, I certify (must initial) that:

_____ Watercourse mapping for this project area previously approved by WMS or the MOA Planning Department's wetlands staff accurately represents current conditions.

I certify under penalty of law that this information was prepared under my direction or supervision. This information is, to the best of my knowledge and belief, true, accurate, and complete. I am aware that there are penalties, including the possibility of fine and imprisonment, for knowing violations.

Signature

Date

Drainage Certification Form – Part B

Medium projects are required to comply with the stormwater treatment requirements described in Chapter 3. Please complete the following sections and include relevant attachments to demonstrate compliance.

1. If your project has received approval for traditional stormwater treatment or alternative compliance, please check the appropriate box below and attached relevant approvals or MOA correspondence.
 - Project has approval for traditional stormwater treatment
 - Project has approval for alternative compliance
 - Not applicable

2. Green Infrastructure treatment must be provided for runoff from the first 0.52 inches of rainfall. Please check all types of facilities you are incorporating into your project to meet this requirement.
 - Bioretention
 - Soak-away Pits
 - Infiltration Basin
 - Infiltration Trenches
 - Vegetated Swales
 - Pervious Pavement
 - Chamber Systems
 - Filter Strips
 - Landscaped Depressions
 - Canopy Cover/Vegetation Retention
 - Other (please list) _____

3. If your facility(s) has approval for traditional treatment, describe the traditional treatment.

4. Is this facility(s) designed in accordance with MOA design criteria presented in the 2016 Anchorage Stormwater Manual Volume 1 (Design Criteria Manual Chapter 2)? Yes No

5. Attach a general plan view drawing and section of the facility(s).

6. Is the facility(s) designed for more than the 0.52 inch event? Yes No

7. Provide the facility(s) design volume. (Filter Strips, Vegetated Swales, and Oil Grit Separators that are designed with a peak intensity may skip this question.)

Attach supporting computations. See page 4-17 of the ASM Volume 1 for instructions on computing this volume.

8. Describe each facility's overflow or bypass system for events larger than the design event. _____

9. Describe the facility(s) maintenance plan. Include a description of maintenance activities and proposed frequency. (Recommended maintenance for various stormwater facilities is included in Chapter 6 of the ASM Volume 1.)
10. Attach the completed Operation and Maintenance Agreement included in Appendix B of the ASM Volume 1.

I certify under penalty of law that this information was prepared under my direction or supervision. This information is, to the best of my knowledge and belief, true, accurate, and complete. I am aware that there are penalties, including the possibility of fine and imprisonment, for knowing violations.

Printed Name _____ Name of Firm _____

Signature _____ Date _____

Phone _____ Email _____

Required attachments: (Include additional attachments as needed to demonstrate compliance.)

- Facility plan view and section
- Volume Computations
- Stormwater Operation and Maintenance Agreement (Note: If desired, a draft agreement may be submitted for projects that will be issued a Conditional Certificate of Occupancy (CCO). A final agreement will be required before a CCO is issued.)
- Additional Attachments. Please list.

Intentionally Left Blank

Drainage Project Notification and WMS Mapping Request

Applicant Name *		Contact Information * (Phone and/or email)	
Mailing Address *			
Property Description * (subdivision, lot(s), and block)			
Plat Number		MOA Assessor's Office Property Identification Number	
MOA Tracking Number(s) (Indicate which provided)			
Project Category * (Check one)	Crossing <input type="checkbox"/> Single-Lot Residential <input type="checkbox"/> Class 1A <input type="checkbox"/> Class 1B <input type="checkbox"/> Class 1C <input type="checkbox"/> Class 1D Small <input type="checkbox"/> Simple <input type="checkbox"/> Complex Large <input type="checkbox"/> Simple <input type="checkbox"/> Complex		
Parcel Physical Location * (Address and/or driving directions)			

Requested Services*

- Review of complete watercourse mapping (must submit mapping to be reviewed)

- Watercourse site review services
 - Feature flagging
 - Notification prior to site visit requested.
 Notifications will be made using the contact information provided; however, contact cannot be guaranteed. Scheduling for applicant presence on site also cannot be guaranteed.
 Requested completion date: _____. (Preferred completion date)
 No later than completion date: _____ (Later completion may incur significant project delay).
 Dates and service availability cannot be guaranteed. Scheduling is based on Planning Department priorities, request receipt order, and seasonal constraints (at minimum, mapping review requires canals to be free of snow and ice.)

* Required Information

Attachments:

- Watercourse mapping (to scale) clearly showing all known streams and major drainageways (reconnaissance level or final depending on service) and the name and location(s) of receiving waters

Certification:

By signature below, I certify that I am legally entitled to authorize the requested services and that the attachments provided are complete and accurate representations of known site conditions and project plans. I further authorize Municipality of Anchorage (MOA) personnel to access the referenced site on foot for the purposes of identifying and / or mapping drainage features.

This form and its attachments constitute my notice to the MOA that I am developing plans for a drainage project or platting action and will be submitting a report of existing or proposed drainage conditions. I understand that all drainage projects are governed by the MOA Project Management and Engineering Design Criteria Manual, the MOA Drainage Design Guidelines, the Anchorage Municipal Code, and other state and federal regulations and permits.

Signed
Date

Intentionally Left Blank

Appendix B:

Sample Operations and Maintenance Agreement and Annual Reporting Form

Intentionally Left Blank

RECORD IN THE ANCHORAGE RECORDING DISTRICT, THIRD JUDICIAL DISTRICT, STATE OF ALASKA

After Recording Return to:

MOA Public Works, Watershed Management Section
P.O. Box 196550
4700 Elmore Road
Anchorage, AK 99519-6650

STORMWATER FACILITY OPERATION AND MAINTENANCE AGREEMENT

The Municipality of Anchorage (hereinafter the "Municipality") and _____

(hereinafter the "Owner(s),") enter into the following AGREEMENT TO OPERATE AND MAINTAIN STORMWATER FACILITIES (hereinafter "this Agreement") which shall become effective on the date the Agreement is fully executed.

The Owner(s) is/are a(n) _____, and _____ execute(s) this Agreement on behalf of the Owner(s) in the capacity of _____ and warrant(s) he/she/they has/have authority to execute this Agreement on behalf of the Owner(s).

The Owner(s) own(s) a parcel of real property (hereinafter "the Property") described as: _____

per plat _____, located in the Anchorage Recording District, Third Judicial District, State of Alaska.

Parcel ID: _____

1.0 RECITALS

1.1 In connection with the Owner's proposed development of the Property, the Municipality has required and the Owner agreed to construct stormwater facilities and to implement an operation and maintenance plan. Stormwater facility design and the operation and maintenance plan were prepared by the engineering firm of _____ for the Owner's property.

1.2 The upkeep and maintenance of stormwater facilities and the implementation of stormwater best management practices (BMPs) is essential for promoting safe and effective drainage and for protecting the integrity of the community's water resources. This agreement contains specific provisions with respect to maintenance of stormwater facilities and the use of stormwater BMPs.

1.3 Whereas, Owner has constructed improvements, including but not limited to, buildings, pavement, and stormwater facilities on the property described above. In order to further the drainage and water quality goals, the Municipality and the Owner hereby enter into this Agreement. The responsibilities of each party to this Agreement are identified below.

2.0 MAINTENANCE

THE OWNER SHALL:

- (1) Implement the stormwater facility maintenance program included herein as Attachment "A."
- (2) Execute periodic major maintenance on the stormwater facilities: including but not limited to: replacing damaged pipes, repairing inlet and outlet structures and resetting flow orifice sizes and elevations, as required.
- (3) Submit to the Municipality annually, documentation of the programs referenced in (1) and (2) above. The report should be submitted to:

MOA Public Works, Watershed Management Section
P.O. Box 196550
4700 Elmore Road
Anchorage, AK 99519-6650

Documentation must be delivered by November 30 of each calendar year. A reporting form is available from the Municipality. Documentation shall contain, at a minimum, the following:

- (a) Name address and telephone of the business, the person, or the firm responsible for operation and maintenance plan implementation, and the person completing the report.

- (b) Time period covered by the report.
 - (c) A chronological summary of the activities conducted to implement the programs referenced in (1) and (2) above. A photocopy of an applicable section of a logbook or work order, with any additional explanation needed, shall normally suffice. For any activities conducted by paid parties not affiliated with the owner, include a copy of the invoices for services.
- (4) Prevent unauthorized modifications to the drainage system and obtain written approval from the Director of Public Works (hereinafter the “Director”) before, grading, filling, and piping, or removing vegetation (except for routine and minor landscaping) that is part of the stormwater facilities. Modifications to stormwater facility quantity and quality controls may require the submittal of revised design drawings, supporting calculations, and modifications to maintenance requirements. The Owner shall obtain all necessary permits before performing all modifications approved by the Director.

THE MUNICIPALITY SHALL:

- (1) Provide technical assistance to the Owner in support of its operation and maintenance activities conducted pursuant to its operations and maintenance program. Said assistance shall be provided upon request, and as Municipality time and resources permit, at no charge to the Owner.
- (2) Review the annual report and conduct a site visit at least once every three years to discuss performance and provide assistance to the Owner.
- (3) Review this Agreement with the Owner and modify it as necessary.

3.0 REMEDIES

- (1) If the Municipality determines that maintenance or repair work, as outlined above in 2.0 Maintenance (1) and (2), is required to be done to the stormwater facilities on the Owner’s property, the Municipality shall give the Owner notice of the specific maintenance and/or repair required. The Municipality shall set a reasonable time in which such work is to be completed by the persons who were given notice; such time shall not extend beyond 30 days, subject to seasonal conditions and concerns. If the above required maintenance and/or repair is not completed within the time set by the Municipality, written notice to assess financial sanctions (AMC 21.13.040.A.4) and/or initiate enforcement proceedings.

- (2) If at any time the Municipality determines that the stormwater facilities create any imminent threat to public health or welfare, the Municipality may take immediate measures to remedy said threat. No notice to the persons listed in (1), above, shall be required under such circumstances.

4.0 ACCESS and FAILURE to MAINTAIN

- (1) The Owner grants unrestricted authority to the Municipality for access to any and all stormwater features for the purpose of performing inspection and maintenance or repair as may become necessary under Remedies (1) and/or (2).
- (2) The persons listed in Remedies (1) above, shall assume all responsibility for the cost of any maintenance or repairs to the stormwater facility. Such responsibility shall include reimbursement to the Municipality within 30 days of the invoice for any such work performed. Overdue payments shall accrue interest at the rate of ten percent (10%) per annum. If legal action ensues, all costs and fees incurred by the Municipality will be borne by the parties responsible for said reimbursements.

5.0 MODIFICATION or TERMINATION

- (1) Entire Agreement; Modification. This Agreement, together with any attachments and other documents referenced herein, sets forth the entire agreement and understanding of the parties under this Agreement, and supersedes all prior agreements, arrangements, understandings and negotiations. No modification of this Agreement shall be effective unless in writing and signed by authorized representatives of the parties to this Agreement.
- (2) Termination. If future conditions render the need for this agreement to expire or terminate, the authorized representatives of the parties shall agree in writing to conditions of termination that may include final inspections and restoration of the property. This Agreement shall not be recognized as terminated until those conditions have been completed and documented.

6.0 BINDING EFFECT

THIS AGREEMENT RUNS WITH THE LAND and inures to the benefit of and is binding upon the parties, their successors, heirs, representatives and assigns.

OWNER

By: _____
Name: _____
Title: _____
Date: _____

OWNER

By: _____
Name: _____
Title: _____
Date: _____

MUNICIPALITY OF ANCHORAGE

By: _____
Name: _____
Title: Public Works Director
Date: _____

STATE OF ALASKA) ss.
THIRD JUDICIAL DISTRICT)

The foregoing instrument was acknowledged before me this _____ day of _____,
20____, by _____, the Public
Works Director of the Municipality of Anchorage or his/her designee, on behalf of the
Municipality of Anchorage.

Notary Public in and for Alaska
My commission expires _____

STATE OF ALASKA) ss.
THIRD JUDICIAL DISTRICT)

The foregoing instrument was acknowledged before me this _____ day of _____,
20____, by _____,
in the capacity of _____.

Notary Public in and for Alaska
My commission expires _____

STATE OF _____) ss.
COUNTY OF _____)

The foregoing instrument was acknowledged before me this _____ day of _____,
20____, by _____,
in the capacity of _____.

Notary Public in and for _____
My commission expires _____

**OPERATIONS AND MAINTENANCE
ANNUAL REPORTING FORM**

DO NOT RECORD THIS PAGE

	<p>PERMANENT STORMWATER CONTROL ANNUAL REPORTING FORM</p>
---	--

This form must be completed and the certification signed by the facility owner or agent and returned to Watershed Management Service, with necessary attachments, by November 30th, for the prior November through October period of time.

GENERAL INFORMATION	
Owner Name (<input type="checkbox"/> check if new):	Reporting Period: November 1, 20____ to October 31, 20____
Facility Address:	
Contact Person (<input type="checkbox"/> check if new) Name: Phone Number(<input type="checkbox"/> check if new): Mailing Address (<input type="checkbox"/> check if new):	
INSPECTION INFORMATION	
Was maintenance required by the O&M Plan performed at this facility? (Please submit inspections logs or invoices documenting maintenance performed)	<input type="checkbox"/> YES <input type="checkbox"/> NO
Have any changes been made to the O&M Plan for the facility? (If yes, please attach additional documentation describing changes)	<input type="checkbox"/> YES <input type="checkbox"/> NO
Were any major repairs or replacements required? (If yes, please attach additional documentation describing changes)	<input type="checkbox"/> YES <input type="checkbox"/> NO
Please indicate if any of the following deficiencies were noted during your inspections	
<input type="checkbox"/> Vegetation outside the facility that is leaning unnaturally or lying on the ground	<input type="checkbox"/> Erosion or exposed dirt in or around the facility
<input type="checkbox"/> Standing water for long periods of time (3 or more days) after regular, small rainfall events	<input type="checkbox"/> Drainage problems downstream of the facility
<input type="checkbox"/> Indications of improper function or bypassing of stormwater flows	

I certify that to the best of my knowledge and belief the maintenance and inspection of the permanent BMPs is being implemented in accordance to the Post Construction Stormwater Facility Operation and Maintenance Plan for this property or that a notice of any deficiencies has been provided.

_____ Signature

_____ Date

ATTACHMENT A: Site Stormwater Operations & Maintenance Manual

ACME Shopping Center
1234 Any Road, Block 1 Lot 1 Some Subdivision
Anchorage, AK

Prepared for: John Doe

Prepared by: ABC Engineering, LLC

February, 2015

DO NOT RECORD THIS PAGE

Selected Permanent Stormwater BMPs (See Attached Figure)

The below section provides a brief description of stormwater BMPs unique to this site. Maintenance requirements for these facilities are discussed along with the more generic BMPs installed on-site in the Operation and Maintenance Schedule.

Vegetated Swale

To provide permanent stormwater treatment, a vegetated swale has been designed to direct stormwater flows to the piped storm drain system. The swale will act as a permanent control for the site. The swale is approximately 150 feet in length and is designed to provide treatment as well as regulate peak flows leaving the site. The outlet weir of the swale is designed to allow sediment to settle out prior to stormwater flows entering the storm drain system.

Bio-retention Area

A vegetated bio-retention area has been constructed to treat stormwater runoff from roofs and walkways. The bio-retention facility has been incorporated into the landscaping located at the front entrance to the building. The bio-retention is approximately 400 square feet in area. The facility has been fitted with a high flow intake designed for larger storm events and been fitted with an underdrain connected to the piped storm drain system.

General Site Operations and Maintenance Schedule**Parking Area**

- Parking area is to be swept twice annually to remove excess sediment. Recommended sweeping should take place once after spring melt and prior to May 15, and once after August 15 and prior to October 15.

Catch Basins, Stormdrain Manholes

- Annual Inspection to ensure that inlets and piping inverts are free from blockage
- Clean as required, or at least every three years

Oil and Grit Separator (OGS)

- Inspect twice during first year, per manufacturer
- Inspect annually to ensure that inlets and piping inverts are free from blockage
- Clean when sediment depth reaches 15% of capacity or in normal when catch basins require cleaning

Field Inlets, Curb Inlets

- Monthly inspection to ensure that inlets are free from blockage
- Remove trash and debris as needed

Vegetative Swale

DO NOT RECORD THIS PAGE

- Monthly inspection for trash and debris; remove as required
- Annual inspection for condition of soil and vegetation
- Re-vegetate and remove accumulated sediment as-needed

Bio-retention Area

- Maintenance and inspection of plant condition as part of normal landscaping, or at least once per year
- Replace dead plants as-needed
- Inspect annually for accumulated sediment, remove as necessary
- Inspect/maintain high flow inlet and riser as per field/curb inlets

DO NOT RECORD THIS PAGE

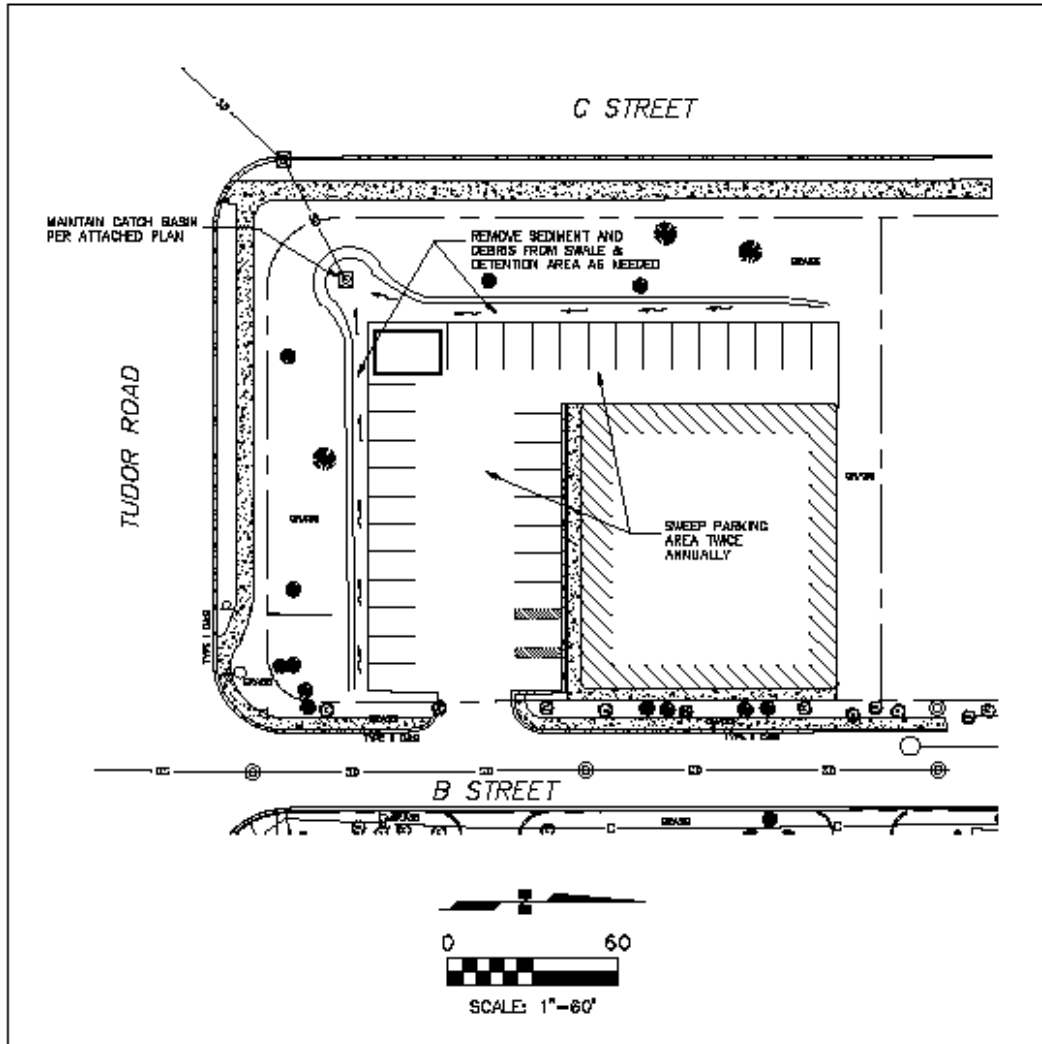

<p>MUNICIPALITY</p>  <p>OF ANCHORAGE</p>	<p>STORMWATER OPERATIONS AND MAINTENANCE MANUAL</p> <p>ACME SHOPPING CENTER</p> <p>1234 ANY ROAD, ANCHORAGE, AK</p>	
	<p>OWNER'S INITIALS: <u>ABC</u></p> <p>ATTACHED TO: <u>XYZ O&M MANUAL</u></p> <p>PAGE <u>1</u> OF <u>1</u> DATED: <u>2/5/2015</u></p>	<p>PROJECT NO. <u>019-1234</u></p> <p>CAD DWG FILE: <u>O&M MANUAL.DWG</u></p> <p>DESIGNED BY: <u>JDU</u> DRAWN BY: <u>GCS</u></p>

DO NOT RECORD THIS PAGE

Intentionally Left Blank

Appendix C: Anchorage Drainage Studies Inventory

Intentionally Left Blank

Anchorage Drainage Studies Inventory

Document Name	Mo/Year	Author	Study Boundaries	Document Location/ WMS Ref. #	Notes	Study Type
Hood Creek Flood Bypass Rehabilitation Design Study	Mar-95	Montgomery Watson	Hood Creek- Jones Lake to Northern Lights Blvd.			Drainage
Fish Creek Improvements Northwood Drive to Minnesota Drive Conceptual Design Report	Feb-96	HDR	Northwood Dr. to Minnesota Dr.			Conceptual Design
Storm Drainage Study for Chester Creek	Aug-96	A.L. Renshaw/ H.P. Nicholson	Chester Creek	WMS - REP 18, 19, 441	Rational Method, 6-yr storm	Drainage
Glacier-Winner Creek Access Corridor Study - Draft Preliminary Routing Report	Nov-96	DOWL Engineers	Glacier-Winner Creek	HDR		Other
King Street/ 100th Ave. Upgrade: Dimond Blvd. to Old Seward Hwy.	Mar-97	USKH	King Street/ 100th Ave./ Dimond Blvd./ Old Seward Hwy.	WMS - REP 41		Design Study Report
Baxter Road/ Beaver Place Improvements Design Study Report	Sep-97	Lounsbury & Assoc. Inc.	Baxter Road/ Beaver Place	WMS - REP 6		Design Study Report
Chester Creek Wetland Hydrologic Analysis	Oct-98	HDR	Chester Creek	WMS - REP 372, 373	SWMM, Aug 98 storm	Other
Indian Creek Flood Analysis	Nov-98	HDR	Indian Valley	HDR	HEC-RAS, 100-yr event	Flood
Ship Creek Trail Design Study Report	Feb-99	USKH	Ship Creek Trail	WMS - REP 330		Design Study Report
Alyeska Creek Floodplain Study	Sep-00	HDR	Girdwood/ Alyeska Creek	HDR	HEC-RAS, 100-yr event, Technical Study Notebook	Flood
MOA Watershed Mapping - Hillside Drainage Atlas	Jan-03	Watershed Mgmt. Services	Hillside Area	WMS - CD 3, 4, 6		Atlas

Fish Creek Improvements Phase IV	Jan-03	HDR	Fish Creek Area & Basin	HDR	XPSWMM: SCS (HEC-1) & EPA 10-yr & 100-yr, 3 hr storm from Aug 1989	Design Study Report
Virgin Creek Floodplain Study	Aug-02	HDR	Girdwood/ Virgin Creek	HDR	HEC-RAS, Technical Study Notebook	Flood
Hydrology/Hydraulics Report for Meadow Creek near Eagle River, Alaska	Apr-04	W. F. (Skip) Barber	Meadow Creek			Hydrology Report
Furrow Creek Flood Study Hydrology Model Summary Report	Oct-07	HDR	Furrow Creek			Flood
Pilot Watershed Drainage Plan Little Rabbit Creek and Little Survival Creek Watersheds	Dec-07	HDR & WHPacific	Little Rabbit Creek and Little Survival Creek Watersheds	WMS	HEC-HMS, SCS 10-yr 24 hr analysis	Drainage
Potter Creek Watershed Drainage Plan	Nov-08	HDR and WHPacific	Potter Creek Watershed			Drainage
California Creek and Glacier Creek Flood Insurance Studies	Dec-08	HDR	Girdwood/ California and Glacier Creeks			Flood
Flood Insurance Study for Furrow Creek	Apr-09	HDR	Furrow Creek (lower portion)			Flood

Appendix D: MOA Hyetographs

Intentionally Left Blank

Anchorage and Eagle River 24-hour Rainfall Distribution in 6-minute (0.1 hour) increments

Time (hr)	Cumulative Fraction	Time (hr)	Cumulative Fraction	Time (hr)	Cumulative Fraction	Time (hr)	Cumulative Fraction	Time (hr)	Cumulative Fraction	Time (hr)	Cumulative Fraction
0.1	0.00189	4.6	0.10808	9.1	0.25631	13.6	0.68341	18.1	0.85354	22.6	0.97168
0.2	0.0038	4.7	0.11091	9.2	0.26074	13.7	0.68825	18.2	0.85661	22.7	0.97384
0.3	0.00573	4.8	0.11376	9.3	0.2652	13.8	0.69307	18.3	0.85967	22.8	0.97597
0.4	0.00768	4.9	0.11663	9.4	0.2697	13.9	0.69784	18.4	0.8627	22.9	0.97809
0.5	0.00965	5	0.11952	9.5	0.27423	14	0.70258	18.5	0.86571	23	0.98018
0.6	0.01165	5.1	0.12244	9.6	0.2788	14.1	0.70729	18.6	0.86871	23.1	0.98226
0.7	0.01366	5.2	0.12537	9.7	0.2834	14.2	0.71196	18.7	0.87168	23.2	0.98431
0.8	0.01569	5.3	0.12832	9.8	0.28804	14.3	0.7166	18.8	0.87463	23.3	0.98634
0.9	0.01774	5.4	0.13129	9.9	0.29271	14.4	0.7212	18.9	0.87756	23.4	0.98835
1	0.01982	5.5	0.13429	10	0.29742	14.5	0.72577	19	0.88048	23.5	0.99035
1.1	0.02191	5.6	0.1373	10.1	0.30216	14.6	0.7303	19.1	0.88337	23.6	0.99232
1.2	0.02403	5.7	0.14033	10.2	0.30693	14.7	0.7348	19.2	0.88624	23.7	0.99427
1.3	0.02616	5.8	0.14339	10.3	0.31175	14.8	0.73926	19.3	0.88909	23.8	0.9962
1.4	0.02832	5.9	0.14646	10.4	0.31659	14.9	0.74369	19.4	0.89192	23.9	0.99811
1.5	0.03049	6	0.14956	10.5	0.32148	15	0.74808	19.5	0.89473	24	1
1.6	0.03269	6.1	0.15267	10.6	0.32728	15.1	0.75179	19.6	0.89752		
1.7	0.03491	6.2	0.15581	10.7	0.33334	15.2	0.75547	19.7	0.90028		
1.8	0.03714	6.3	0.15897	10.8	0.33964	15.3	0.75914	19.8	0.90303		
1.9	0.0394	6.4	0.16214	10.9	0.34619	15.4	0.76279	19.9	0.90576		
2	0.04168	6.5	0.16534	11	0.35298	15.5	0.76642	20	0.90847		
2.1	0.04398	6.6	0.16856	11.1	0.36003	15.6	0.77002	20.1	0.91115		
2.2	0.0463	6.7	0.1718	11.2	0.36732	15.7	0.77361	20.2	0.91382		
2.3	0.04864	6.8	0.17506	11.3	0.37486	15.8	0.77717	20.3	0.91647		
2.4	0.051	6.9	0.17834	11.4	0.38265	15.9	0.78072	20.4	0.91909		
2.5	0.05338	7	0.18164	11.5	0.39068	16	0.78424	20.5	0.9217		
2.6	0.05578	7.1	0.18496	11.6	0.40026	16.1	0.78775	20.6	0.92428		
2.7	0.0582	7.2	0.1883	11.7	0.41117	16.2	0.79123	20.7	0.92685		
2.8	0.06064	7.3	0.19166	11.8	0.42585	16.3	0.79469	20.8	0.92939		
2.9	0.0631	7.4	0.19504	11.9	0.44681	16.4	0.79814	20.9	0.93191		
3	0.06558	7.5	0.19844	12	0.48521	16.5	0.80156	21	0.93442		
3.1	0.06809	7.6	0.20186	12.1	0.55319	16.6	0.80496	21.1	0.9369		
3.2	0.07061	7.7	0.20531	12.2	0.57415	16.7	0.80834	21.2	0.93936		
3.3	0.07315	7.8	0.20877	12.3	0.58883	16.8	0.8117	21.3	0.9418		
3.4	0.07572	7.9	0.21225	12.4	0.59974	16.9	0.81504	21.4	0.94422		
3.5	0.0783	8	0.21576	12.5	0.60932	17	0.81836	21.5	0.94662		
3.6	0.08091	8.1	0.21928	12.6	0.61735	17.1	0.82166	21.6	0.949		
3.7	0.08353	8.2	0.22283	12.7	0.62514	17.2	0.82494	21.7	0.95136		
3.8	0.08618	8.3	0.22639	12.8	0.63268	17.3	0.8282	21.8	0.9537		
3.9	0.08885	8.4	0.22998	12.9	0.63997	17.4	0.83144	21.9	0.95602		
4	0.09153	8.5	0.23358	13	0.64702	17.5	0.83466	22	0.95832		
4.1	0.09424	8.6	0.23721	13.1	0.65381	17.6	0.83786	22.1	0.9606		
4.2	0.09697	8.7	0.24086	13.2	0.66036	17.7	0.84103	22.2	0.96286		
4.3	0.09972	8.8	0.24453	13.3	0.66666	17.8	0.84419	22.3	0.96509		
4.4	0.10248	8.9	0.24821	13.4	0.67272	17.9	0.84733	22.4	0.96731		
4.5	0.10527	9	0.25192	13.5	0.67852	18	0.85044	22.5	0.96951		

Girdwood 24-hour Rainfall Distribution in 6-minute (0.1 hour) increments

Time (hr)	Cumulative Fraction	Time (hr)	Cumulative Fraction	Time (hr)	Cumulative Fraction	Time (hr)	Cumulative Fraction	Time (hr)	Cumulative Fraction	Time (hr)	Cumulative Fraction
0.1	0.0038	4.6	0.17692	9.1	0.35448	13.6	0.59287	18.1	0.77225	22.6	0.94664
0.2	0.0076	4.7	0.18081	9.2	0.35851	13.7	0.59693	18.2	0.77617	22.7	0.95047
0.3	0.0114	4.8	0.18471	9.3	0.36255	13.8	0.601	18.3	0.78009	22.8	0.95429
0.4	0.0152	4.9	0.18861	9.4	0.36659	13.9	0.60506	18.4	0.78401	22.9	0.95811
0.5	0.01901	5	0.19252	9.5	0.37063	14	0.60912	18.5	0.78793	23	0.96193
0.6	0.02281	5.1	0.19642	9.6	0.37467	14.1	0.61318	18.6	0.79184	23.1	0.96575
0.7	0.02662	5.2	0.20033	9.7	0.37872	14.2	0.61723	18.7	0.79576	23.2	0.96956
0.8	0.03044	5.3	0.20424	9.8	0.38277	14.3	0.62128	18.8	0.79967	23.3	0.97338
0.9	0.03425	5.4	0.20816	9.9	0.38682	14.4	0.62533	18.9	0.80358	23.4	0.97719
1	0.03807	5.5	0.21207	10	0.39088	14.5	0.62937	19	0.80748	23.5	0.98099
1.1	0.04189	5.6	0.21599	10.1	0.39494	14.6	0.63341	19.1	0.81139	23.6	0.9848
1.2	0.04571	5.7	0.21991	10.2	0.399	14.7	0.63745	19.2	0.81529	23.7	0.9886
1.3	0.04953	5.8	0.22383	10.3	0.40307	14.8	0.64149	19.3	0.81919	23.8	0.9924
1.4	0.05336	5.9	0.22775	10.4	0.40713	14.9	0.64552	19.4	0.82308	23.9	0.9962
1.5	0.05718	6	0.23168	10.5	0.41121	15	0.64955	19.5	0.82698	24	1
1.6	0.06101	6.1	0.2356	10.6	0.41533	15.1	0.65354	19.6	0.83087		
1.7	0.06485	6.2	0.23953	10.7	0.41946	15.2	0.65753	19.7	0.83476		
1.8	0.06868	6.3	0.24347	10.8	0.4236	15.3	0.66151	19.8	0.83865		
1.9	0.07252	6.4	0.2474	10.9	0.42776	15.4	0.6655	19.9	0.84254		
2	0.07635	6.5	0.25134	11	0.43192	15.5	0.66948	20	0.84642		
2.1	0.08019	6.6	0.25527	11.1	0.4361	15.6	0.67346	20.1	0.8503		
2.2	0.08404	6.7	0.25922	11.2	0.44029	15.7	0.67744	20.2	0.85418		
2.3	0.08788	6.8	0.26316	11.3	0.44448	15.8	0.68141	20.3	0.85806		
2.4	0.09173	6.9	0.2671	11.4	0.44869	15.9	0.68539	20.4	0.86194		
2.5	0.09558	7	0.27105	11.5	0.45291	16	0.68936	20.5	0.86581		
2.6	0.09943	7.1	0.275	11.6	0.45729	16.1	0.69333	20.6	0.86968		
2.7	0.10328	7.2	0.27895	11.7	0.46171	16.2	0.69729	20.7	0.87355		
2.8	0.10714	7.3	0.28291	11.8	0.46771	16.3	0.70126	20.8	0.87742		
2.9	0.111	7.4	0.28686	11.9	0.47668	16.4	0.70522	20.9	0.88128		
3	0.11486	7.5	0.29082	12	0.49335	16.5	0.70918	21	0.88514		
3.1	0.11872	7.6	0.29478	12.1	0.52332	16.6	0.71314	21.1	0.889		
3.2	0.12258	7.7	0.29874	12.2	0.53229	16.7	0.71709	21.2	0.89286		
3.3	0.12645	7.8	0.30271	12.3	0.53829	16.8	0.72105	21.3	0.89672		
3.4	0.13032	7.9	0.30667	12.4	0.54271	16.9	0.725	21.4	0.90057		
3.5	0.13419	8	0.31064	12.5	0.54709	17	0.72895	21.5	0.90442		
3.6	0.13806	8.1	0.31461	12.6	0.55131	17.1	0.7329	21.6	0.90827		
3.7	0.14194	8.2	0.31859	12.7	0.55552	17.2	0.73684	21.7	0.91212		
3.8	0.14582	8.3	0.32256	12.8	0.55971	17.3	0.74079	21.8	0.91596		
3.9	0.1497	8.4	0.32654	12.9	0.5639	17.4	0.74473	21.9	0.91981		
4	0.15358	8.5	0.33052	13	0.56808	17.5	0.74866	22	0.92365		
4.1	0.15746	8.6	0.3345	13.1	0.57224	17.6	0.7526	22.1	0.92748		
4.2	0.16135	8.7	0.33849	13.2	0.5764	17.7	0.75653	22.2	0.93132		
4.3	0.16524	8.8	0.34247	13.3	0.58054	17.8	0.76047	22.3	0.93515		
4.4	0.16913	8.9	0.34646	13.4	0.58467	17.9	0.7644	22.4	0.93899		
4.5	0.17302	9	0.35045	13.5	0.58879	18	0.76832	22.5	0.94282		

MOA 2-year, 6-hour Design Storm
From: JMM Consulting Engineers Inc, 1991

Time (minutes)	Precipitation (inches)	Time (minutes)	Precipitation (inches)	Time (minutes)	Precipitation (inches)
5	0.004	125	0.007	245	0.007
10	0.004	130	0.007	250	0.006
15	0.004	135	0.007	255	0.006
20	0.004	140	0.008	260	0.006
25	0.004	145	0.008	265	0.006
30	0.005	150	0.009	270	0.006
35	0.005	155	0.009	275	0.006
40	0.005	160	0.010	280	0.005
45	0.005	165	0.011	285	0.005
50	0.005	170	0.013	290	0.005
55	0.005	175	0.015	295	0.005
60	0.005	180	0.062	300	0.005
65	0.005	185	0.016	305	0.005
70	0.005	190	0.015	310	0.005
75	0.005	195	0.014	315	0.005
80	0.005	200	0.011	320	0.005
85	0.005	205	0.010	325	0.005
90	0.006	210	0.009	330	0.005
95	0.006	215	0.009	335	0.005
100	0.006	220	0.008	340	0.004
105	0.006	225	0.008	345	0.004
110	0.006	230	0.007	350	0.004
115	0.006	235	0.007	355	0.004
120	0.007	240	0.007	360	0.004
Total volume: 0.53 inches					

MOA Snow Melt Hyetographs

Model Event (March 10, 1969)		5-Year Recurrence (March 23, 1974)	
Time (hours)	Snow melt (inches) *	Time (hours)	Snow melt (inches)*
1	.02	1	.01
2	.02	2	.02
3	.02	3	.02
4	.02	4	.02
5	.02	5	.02
6	.02	6	.02
7	.03	7	.03
8	.03	8	.03
9	.03	9	.03
10	.02	10	.02
11	.02	11	.02
12	.02	12	.01
13	.01	13	.01
14	.00	14	.02
15	.00	15	.01
16	.01	16	.01
17	.01	17	.01
18	.01	18	.00
19	.00	19	.00
20	.00	20	.00
		21	.00
		22	.00
		23	.00
		24	.01
		25	.03
		26	.04
		27	.05
		28	.04
		29	.04
		30	.05
		31	.06
		32	.06
		33	.06
		34	.05
		35	.04
		36	.03
		37	.02
		38	.01
		39	.00
		40	.00
* Inches of water			

Appendix E: Plant List

Intentionally Left Blank

Plant List

	Filter Zones (Dry)	Intermittent Zones (Intermittent soil saturation)	Pool Margins (Permanent soil saturation)	Pool Zones (Deep water)
Trees	<i>Picea glauca</i>	<i>Populus trichocarpa</i>	<i>B. pumila</i>	
	White Spruce	Black cottonwood	Bog Birch	
	<i>Picea mariana</i>	<i>Picea mariana</i>	<i>Potentilla palustris</i>	
	Black spruce	Black spruce	Bog Cinquefoil	
	<i>Betula papyrifera</i>			
	Paper birch			
	<i>Betula neoalaskana</i>			
	Alaska paper birch			
	<i>Populus balsamifera</i>			
	Balsam poplar			
	<i>Populus tremuloides</i>			
	Quaking aspen			
	<i>Larix russica</i>			
	Siberian larch			
	<i>Pinus sylvestris</i>			
Scotch pine				
Shrubs	<i>Salix bebbiana</i> *	<i>Dasiphora fruticosa</i>	<i>Myrica gale</i>	
	Bebb willow	Shrubby cinquefoil	sweet Gale	
	<i>Salix scouleriana</i> *	<i>Cornus sericea</i>	<i>Cornus sericea</i>	
	Scouler willow	Red-osier dogwood	Red-osier dogwood	
	<i>Viburnum edule</i>	<i>Cornus sericea</i>	<i>Cornus sericea</i>	
	Highbush cranberry	'flaviramea'	'flaviramea'	
		Yellow-twig dogwood	Yellow-twig dogwood	
	<i>Aronia</i>	<i>Salix lasiandra</i> *	<i>Ledum</i>	
	<i>melanocarpa</i>	Pacific willow	<i>groenladicum</i>	
	Black chokeberry		Labrador tea	
	<i>Juniperus communis</i>	<i>Betula glandulosa</i>		
	Common juniper	Shrub birch		
	<i>Juiperus horizontalis</i>	<i>Betula nana</i>		
	Creeping juniper	Dwarf birch		
	<i>Amelanchier</i>	<i>Ledum groenladicum</i>		
	<i>alnifolia</i>	Labrador tea		
	Serviceberry			
	<i>Arctostaphylos uva-</i> <i>ursi</i>	<i>Luetkea pectinata</i>		
	Kinnikinnik	Alaska spirea		
	<i>Cornus canadensis</i>	<i>Luetkea stevenii</i>		
Bunchberry dogwood	Steven spirea			
<i>Rosa acicularis</i>	<i>Sorbus scopulina</i>			
Wild rose	Green mountain ash			
Grasses	<i>Calamagrostis</i> <i>canadensis</i>	<i>Calamagrostis</i> <i>canadensis</i>	<i>Glyceria maxima</i>	<i>Glyceria Striata</i>
	Bluejoint reedgrass	Bluejoint reedgrass	Reed manna grass	Fowl manna grass
	<i>Elymus macrourus</i>	<i>Elymus macrourus</i>	<i>Beckmannia</i>	
	Tufted wheatgrass	Tufted wheatgrass	<i>syzigachne</i>	
			Egan sloughgrass	
	<i>Festuca rubra</i> *	<i>Festuca rubra</i> *		
	Red fescue	Red fescue		
	<i>Deschampsia</i> <i>cespitosa</i>	<i>Deschampsia</i> <i>cespitosa</i>		
Tufted hairgrass	Tufted hairgrass			

	Filter Zones (Dry)	Intermittent Zones (Intermittent soil saturation)	Pool Margins (Permanent soil saturation)	Pool Zones (Deep water)
	<i>Poa eminens</i>	<i>Poa eminens</i>		
Grass-likes		<i>Carex lyngbyei</i>	<i>Juncus tenuis</i> Slender rush	<i>Carex gmelinii</i> Gmelin’s sedge
			<i>Juncus ensifolius</i> Three stamen rush	<i>Eleocharis quadrangulata</i> Square-stemmed spike Rush
			<i>Carex lyngbyei</i>	<i>Juncus effuses</i> Soft rush
				<i>Eleocharis palustris</i> Creeping spikerush
				<i>Scirpus microcapus</i> Small fruit bullrush
			<i>Scirpus validus</i> Softstem bullrush	
			<i>Eleocharis acicularis</i> Least spikerush	
			<i>Scirpus acutus</i> Hard-stemmed bullrush	
			<i>Scirpus americanus</i> Olney’s bulrush	
Aquatics		<i>Plantago maritima</i>	<i>Plantago maritima</i>	
				<i>Brasenia schreberi</i> Watershield
				<i>Triglochin maritimum</i> Seaside arrow grass
			<i>Ceratophyllum demersum</i> Common hornwort	
			<i>Zannichellia palustris</i> Horned pondweed	
			<i>Lemna minor</i> Lesser duckweed	
			<i>Zostera marina</i> Eel grass	
			<i>Nymphaea tetragona</i> Pigmy water lily	
			<i>Potamegeton natans</i> Floating leaf pondweed	
			<i>Oenanthe sarmentosa</i> Water parsley	
			<i>Potamegeton pectinatus</i> Sago pondweed	
			<i>Potamegeton foliosus</i> Leafy pondweed	
			<i>Potamegeton pusillus</i> Small pondweed	
			<i>Potamegeton gramineus</i> Grassy pondweed	
			<i>Potamegeton zosteriformis</i> Flat-stemmed pondweed	
			<i>Typha latifolia*</i> Broad-leaf cattail	
			<i>Ruppia maritime</i> Widgeon-grass	
Wildflowers	<i>Corydalis sempervirens</i> Golden corydalis	<i>Dodecatheon sp.</i> Shooting star	<i>Dodecatheon sp.</i> Shooting star	<i>Hippuris tetraphylla</i>
	<i>Aquilegia sp.</i> Columbine	<i>Aconitum delphinifolium</i> Monkshood	<i>Geranium erianthum</i> Wild geranium	
	<i>Polemonium pulcherrimum</i> Beautiful Jacob’s ladder	<i>Geranium erianthum</i> Wild geranium	<i>Fritillaria camschatcensis</i> Chocolate lily	
		<i>Oplopanax horridus</i> Devil’s club	<i>Dryopteris expansa</i> Shield fern	
		<i>Aquilegia sp.</i> Columbine	<i>Iris setosa</i> Wild iris	

Filter Zones (Dry)	<i>Intermittent Zones (Intermittent soil saturation)</i>	Pool Margins (Permanent soil saturation)	Pool Zones (Deep water)
	<i>Aruncus dioicus</i> Goat's beard	<i>Iris pseudacorus</i> Paleyellow iris	
	<i>Athyrium filix-femina</i> Lady fern	<i>Mertensia paniculata</i> Tall bluebells	
	<i>Corydalis sempervirens</i> Golden corydalis	<i>Hippuris tetraphylla</i>	
	<i>Fritillaria camschatcensis</i> Chocolate lily		
	<i>Dryopteris expansa</i> Shield fern		
	<i>Hemerocallis sp.</i> Daylily		
	<i>Iris setosa</i> Wild iris		
	<i>Matteuccia struthiopteris</i> Ostrich fern		
	<i>Mertensia paniculata</i> Tall bluebells		
	<i>Myosotis alpestris</i> Forget-me-knot		
	<i>Polemonium acutiflorum</i> Tall jacob's ladder		
	<i>Thalictrum sp.</i> Meadow rue		
	<i>Trollius sp.</i> Globeflower		
	<i>Filipendula sp.</i> Meadowsweet		
	<i>Aster sibiricus</i> Siberian aster		

This list is an example of plant species suitable for use in constructed stormwater treatment facilities. This is not a comprehensive list, and facility designers should develop a planting regime that incorporates a wide range of species based on individual site characteristics and plant availability. The use of additional plants outside of this list are encouraged, provided the selected plants are native/non-invasive and are appropriate for the design soil condition.

** - Hyperaccumulators: Plants known in Alaska to be capable of accumulating or tolerating contaminants at greater levels than common nonaccumulator plants.*

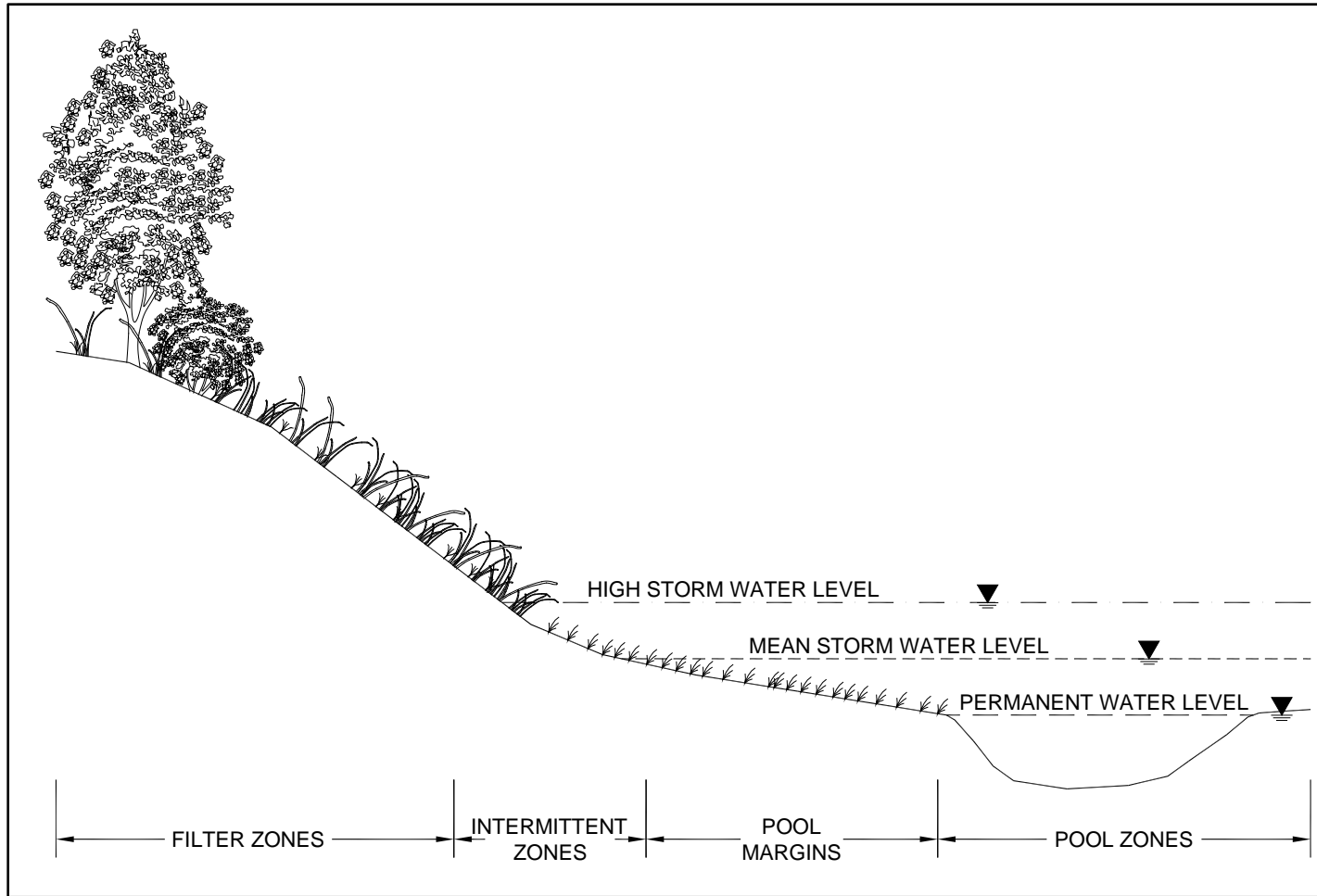

Figure 1: Planting Zones

Appendix F:

Class V Injection Well Memorandum

Intentionally Left Blank



UNITED STATES ENVIRONMENTAL PROTECTION AGENCY
WASHINGTON, D.C. 20460

JUN 13 2008

OFFICE OF
WATERMEMORANDUM

SUBJECT: Clarification on which stormwater infiltration practices/technologies have the potential to be regulated as "Class V" wells by the Underground Injection Control Program

TO: Water Division Directors, Regions 1-10

FROM: *Linda Boornazian*
Linda Boornazian, Director
Water Permits Division (MC 4203M)

Steve Heare
Steve Heare, Director
Drinking Water Protection Division (MC 4606M)

Over the past several years stormwater infiltration has become an increasingly effective tool in the management of stormwater runoff. Although primary stormwater management responsibilities within EPA fall under the Clean Water Act (CWA), the infiltration of stormwater is, in some cases, regulated under the Safe Drinking Water Act (SDWA) with the goal of protecting underground sources of drinking water (USDWs). Surface and ground water protection requires effective integration between the overlapping programs. This memorandum is a step forward in that effort and is meant to provide clarification on stormwater implementation and green infrastructure, in particular under the CWA, which is consistent with the requirements of the SDWA's Underground Injection Control (UIC) Program.

In April 2007, EPA entered into a collaborative partnership with four national groups (the Association of State and Interstate Water Pollution Control Administrators, the Low Impact Development Center, the National Association of Clean Water Agencies, and the Natural Resources Defense Council) to promote green infrastructure as a cost-effective, sustainable, and environmentally friendly approach to stormwater management. The primary goals of this collaborative effort are to reduce runoff volumes and sewer overflow events through the use of green infrastructure wet weather management practices.

Within the context of this collaborative partnership, green infrastructure includes a suite of management practices that use soils and vegetation for infiltration, treatment, and evapotranspiration of stormwater. Rain gardens, vegetated swales, riparian buffers and porous pavements are all common examples of green infrastructure techniques that capture and treat stormwater runoff close to its source. Green infrastructure management practices typically do not include commercially manufactured or proprietary infiltration

Internet Address (URL) • <http://www.epa.gov>

Recycled/Recyclable • Printed with Vegetable Oil Based Inks on Recycled Paper (Minimum 30% Postconsumer)

devices or other infiltration practices such as simple drywells, which do not provide for pre-treatment prior to infiltration.

The partnership is promoting green infrastructure as an effective approach to stormwater management because these practices are associated with a number of environmental benefits. In addition to reducing and delaying runoff volumes, green infrastructure approaches can also reduce pollutant levels in stormwater, enhance ground water recharge, protect surface water from stormwater runoff, increase carbon sequestration, mitigate urban heat islands, and increase wildlife habitat.

Given the multiple benefits that green infrastructure can provide, EPA and its partners have increased efforts to incorporate green infrastructure techniques into stormwater management strategies nationwide. In recent years, public support for these practices has gradually increased. For more information on green infrastructure, please visit www.epa.gov/npdes/greeninfrastructure.

There are cases where stormwater infiltration practices are regulated as Class V wells under the UIC program, and State and local stormwater managers report that some developers are hesitant to incorporate green infrastructure practices because they fear regulatory approvals will slow the process and increase costs. EPA believes those fears are unfounded and notes that most green infrastructure practices do not meet the Class V well definition and can be installed without regulatory oversight by the UIC Program. However, EPA remains committed to the protection of USDWs and emphasizes the need for UIC program compliance (per 40 CFR 144).

To provide clarification on which stormwater infiltration techniques meet EPA's UIC Class V well definition, EPA's Office of Water has developed the attached "Class V Well Identification Guide." State or Regional stormwater and nonpoint source control programs, developers, and other interested parties are requested to contact the State or Regional UIC Program Director with primary authority for the UIC Class V program when considering the use of practices that have been identified, or potentially identified, as Class V wells. UIC program managers should consider the proximity to sensitive ground water areas when looking at the suitability of stormwater infiltration practices. Depending on local conditions, infiltration without pretreatment may not be appropriate in areas where ground waters are a source of drinking water or other areas identified by federal, state, or local governments as sensitive ground water areas, such as aquifers overlain with thin, porous soils.

Please share this memo and the attached guide with your State and Regional stormwater, nonpoint source control, UIC and other ground water managers, as well as with appropriate green infrastructure contacts. These programs are encouraged to coordinate on stormwater management efforts when sensitive ground water issues arise.

Attachment

Underground Injection Control (UIC) Program Class V Well Identification Guide

This reference guide can be used to determine which stormwater infiltration practices/technologies have the potential to be regulated as “Class V” wells. Class V wells are wells that are not included in Classes I through IV. Typically, Class V wells are shallow wells used to place a variety of fluids directly below the land surface. By definition, a well is “any bored, drilled, driven shaft, or dug hole that is deeper than its widest surface dimension, or an improved sinkhole, or a subsurface fluid distribution system” and an “injection well” is a “well” into which “fluids” are being injected (40 CFR §144.3). Federal regulations (40 CFR §144.83) require all owners/operators of Class V wells to submit information to the appropriate regulatory authorities including the following:

1. Facility name and location
2. Name and address of legal contact
3. Ownership of property
4. Nature and type of injection well(s)
5. Operating status of injection well(s)

For more information on Class V well requirements, please visit http://www.epa.gov/safewater/uic/class5/comply_minrequirements.html. For more information on green infrastructure, please visit <http://www.epa.gov/npdes/greeninfrastructure>.

The stormwater infiltration practices/technologies in rows A through I below are generally not considered to be wells as defined in 40 CFR §144.3 because typically they are not subsurface fluid distribution systems or holes deeper than their widest surface dimensions. If these practices/technologies are designed in an atypical manner to include subsurface fluid distribution systems and/or holes deeper than their widest surface dimensions, then they may be subject to the Class V UIC regulations. The stormwater infiltration practices/technologies in rows J through K however, depending upon their design and construction probably would be subject to UIC regulations.

	Infiltration Practice/Technology	Description	Is this Practice/Technology Generally Considered a Class V Well?
F	Tree Boxes & Planter Boxes	Tree boxes and planter boxes are generally found in the right-of-ways alongside city streets. These areas provide permeable areas where stormwater can infiltrate. The sizes of these boxes can vary considerably.	No.
G	Permeable Pavement	Permeable pavement is a porous or pervious pavement surface, often built with an underlying stone reservoir that temporarily stores surface runoff before it infiltrates into the subsoil. Permeable pavement is an environmentally preferable alternative to traditional pavement that allows stormwater to infiltrate into the subsoil. There are various types of permeable surfaces, including permeable asphalt, permeable concrete and even grass or permeable pavers.	No.
H	Reforestation	Reforestation can be used throughout a community to reestablish forested cover on a cleared site, establish a forested buffer to filter pollutants and reduce flood hazards along stream corridors, provide shade and improve aesthetics in neighborhoods or parks, and improve the appearance and pedestrian comfort along roadsides and in parking lots.	No.
I	Downspout Disconnection	A practice where downspouts are redirected from sewer inlets to permeable surfaces where runoff can infiltrate.	In certain circumstances, for example, when downspout runoff is directed towards vegetated/pervious areas or is captured in cisterns or rain-barrels for reuse, these practices generally would not be considered Class V wells.
J	Infiltration Trenches	An infiltration trench is a rock-filled trench designed to receive and infiltrate stormwater runoff. Runoff may or may not pass through one or more pretreatment measures, such as a swale, prior to entering the trench. Within the trench, runoff is stored in the void space between the stones and gradually infiltrates into the soil matrix. There are a number of different design variations.	In certain circumstances, for example, if an infiltration trench is “deeper than its widest surface dimension,” or includes an assemblage of perforated pipes, drain tiles, or other similar mechanisms intended to distribute fluids below the surface of the ground, it would probably be considered a Class V injection well.

	Infiltration Practice/Technology	Description	Is this Practice/Technology Generally Considered a Class V Well?
K	Commercially Manufactured Stormwater Infiltration Devices	Includes a variety of pre-cast or pre-built proprietary subsurface detention vaults, chambers or other devices designed to capture and infiltrate stormwater runoff.	These devices are generally considered Class V wells since their designs often meet the Class V definition of subsurface fluid distribution system.
L	Drywells, Seepage Pits, Improved Sinkholes.	Includes any bored, drilled, driven, or dug shaft or naturally occurring hole where stormwater is infiltrated.	These devices are generally considered Class V wells if stormwater is directed to any bored, drilled, driven shaft, or dug hole that is deeper than its widest surface dimension, or has a subsurface fluid distribution system.

Intentionally Left Blank

Appendix G:

Infiltration Testing Methods and Frequency

Intentionally Left Blank

Infiltration Testing Methods and Frequency

The minimum testing schedule shall be as shown in the Table below.

Testing Schedule for Infiltration Controls

Infiltration Facility Type	Applicable Test Method	Test Frequency
Surface Facilities (filter strip, vegetative swale, and pervious pavement)	<ul style="list-style-type: none"> • Soil Boring w/ Cased Infiltration OR	1 per 10,000 square feet
Subsurface and Basin Facilities (soakaway pit, infiltration trench, bioretention, and chamber system, infiltration basin, constructed wetland, wet pond, and dry pond)	<ul style="list-style-type: none"> • Test Pit w/Falling Head Percolation OR • ASTM D3385 All facilities require installation of a minimum of one piezometer.	For Bottom-controlled infiltration – 1 per 500 square feet For sidewall controlled—1 per 50 linear feet

Initial testing is conducted to provide design feasibility information, and is intended to determine the suitability of a site for installation of various structural stormwater control. Testing shall be performed and submitted as part of the Watershed Management Report. Testing frequency shall be either one field test per facility, regardless of type or size, or shall be conducted in accordance with the testing facility above, whichever is greater. Testing shall be performed at the location of the proposed stormwater control.

Bottom controlled facilities are facilities whose primary infiltration area is considered to be the bottom of the facility (e.g. an infiltration basin). Sidewall controlled facilities are those facilities whose primary infiltration area is considered to be the sidewalls of the facility (e.g. an infiltration trench). Where both cases apply, the more stringent test frequency shall apply.

Soil test borings or test pits shall be advanced a minimum of four feet below the design base of the control and logs of soil strata recorded from the ground surface to the bottom of boring. Test pits may be used instead of borings to collect soil samples but conditions described in following text must still be met for installing piezometers or performing percolation tests. Soil samples shall be collected and laboratory tests for grain size analysis performed of soil samples collected at the base and four feet below the base of the proposed control. Soil sampling and laboratory testing shall be sufficient to determine particle size characteristics (Unified Soil Classification System—ASTM D2487) of representative natural sediments at the base and four feet beneath the base of the proposed control.

A capped piezometer, perforated from the base to four feet below the base of the proposed control and sealed at the ground surface to prevent surface water from entering along the outer casing wall, shall be placed in at least one boring location per control so as to allow measurement of seasonal variation in the shallow groundwater surface at the site.

At least three measurements of the shallow ground water surface shall be obtained from each piezometer between August 1 and October 31 and results reported in terms of depth from ground surface to surface of water in the piezometer.

Infiltration tests and piezometers shall be conducted in a portion of the pit where natural soils are left undisturbed below the proposed base of the structure for a distance of at least 10 feet in diameter from any infiltration and piezometer testing locations. Where piezometers are to be installed in test pits, piezometers shall be placed adjacent to the undisturbed portion of the pit and carefully backfilled to avoid damage. Cased borings may also be used to test infiltration or tests may be done using standard or modified standard ASTM D3385 double-ring infiltration tests performed on the undisturbed pit bottom.

Infiltration tests shall be performed at the location and at the base of the proposed infiltration control. All infiltration testing shall be performed in accordance with the method schedule shown in the table above. The standard method for infiltration testing for surface and basin controls shall be ASTM D3385, 'Standard Test Method for Infiltration Rate of Soils in Field Using Double-Ring Infiltrometer'. The method may be modified to use reduced ring diameters (2.5 and 4.25 inch inner and outer ring dimensions respectively) through application of the IN2-W Turf-Tec Infiltrometer or equal (USEPA 1999).

Trenches or other deep-excavation infiltration controls, may be tested for infiltration using falling head percolation methods modified from EPA (USEPA, 1980). Methods as described in the EPA guidance shall be applied except that in all cases test borings shall be extended a minimum of one foot and a maximum of two feet below the base of the control; non-perforated casing shall be placed so that the bottom of the casing is at the boring bottom; and the annular space between the casing and hole walls completely backfilled and compacted with hole cuttings. The boring shall not be greater than approximately twice the diameter of the casing used in the test. Use of perforated casing shall not be allowed in performing falling head percolation tests. Sorted, washed gravel may be placed at the base of the boring below the bottom of the test casing to minimize hole erosion as water is introduced into the casing, but the total thickness of the placed gravel shall not exceed four inches.

All testing shall be documented in a summary report including: complete description of work history and methods; maps of boring and test locations in relation to proposed controls and project boundaries; tabulation of collected data; calculations and results including laboratory reports and field test results; and graphic logs of all soil borings and test holes showing boring and test installation dimensions, significant strata changes (including any fill) with associated engineering soils descriptions and depths, sample locations and identities related to laboratory tests, and water table (with time and date) and bedrock depths. All vertical measurements shall be reported relative to the undisturbed ground surface.

Appendix H:

Additional Specifications for Bioretention Soils

Intentionally Left Blank

Additional Guidance Engineered Soils

Note: The following guidance for specifying an engineered soil for a bioretention system has been adapted from the Puget Sound Action Team, Low Impact Development Technical Guidance Manual for Puget Sound.

The following bulleted list is intended to assist designers in specifying an engineered soil mix for use in a bioretention system. Soil specifications may vary slightly depending on site characteristics and related design considerations.

- The final soil mix (including compost and soil) should have a long-term hydraulic conductivity of approximately 1.0 inch/hour according to ASTM Designation D 2434 (Standard Test Method for Permeability of Granular Soils) at 80% compaction per ASTM Designation D 1557 (Standard Test Methods for Laboratory Compaction Characteristics of Soil Using Modified Effort). Note that infiltration rate and hydraulic conductivity are assumed to be approximately the same in a uniform mix soil.
- The final soil mixture should have a minimum organic content of 10% by dry weight per ASTM Designation D 2974 (Standard Test Method for Moisture, Ash and Organic Matter of Peat and Other Organic Soils).
- The final soil mixture should be tested by an independent laboratory prior to installation for fertility, micronutrient analysis, and organic material content. Soil amendments per laboratory recommendations (if any) should be uniformly incorporated for optimum plant establishment and early growth.
- The clay content of the final soil mix should be less than 5%.
- The pH for the soil mix should be between 5.5 and 7.0. If the pH falls outside of the acceptable range, it may be modified with lime to increase the pH or iron sulfate plus sulfur to lower the pH. The lime or iron sulfate must be mixed uniformly into the soil prior to use in the bioretention system.
- Soil mix should be uniform and free of stones, stumps, roots, or other similar material greater than 2 inches in diameter.

Unless laboratory analysis indicates otherwise, engineered soils are to be assigned a design infiltration rate of 1.0 inch/hour during design efforts. This value is consistent with a moderately high saturated hydraulic conductivity.

Intentionally Left Blank

Appendix I:

Private Snow Disposal Sites White Paper

Intentionally Left Blank

Private Snow Disposal Sites (On-Site Snow Storage Only)

DRAFT Operations Guidance

Prepared by Scott R Wheaton, MOA Watershed Management Services

Winter 2003

In the United States, about 100 million tons of sand and 10 million tons of salt are applied to roads annually, and similar practices are commonly used on private parking lots. When snow is removed from these surfaces during plowing and snow disposal operations, part of the sand and salt applications are also removed, along with additional pollutants released by traffic. When the snow melts and discharges from snow stored at the snow disposal sites, some of these pollutants are carried away with the melt water. In addition to chloride and sediment pollutants, the high salt content of the melt water can also increase mobilization of the more toxic form of certain metals. Unchecked, these pollutants can clog drainages, damage pavements, promote noxious growths, kill or stunt ornamental and natural vegetation, contaminate surface and ground water supplies, and reduce important and valuable fish stocks.

Fortunately, a growing understanding of snow melt water processes provides operators with valuable insight into practicable methods that can be used to economically control pollutants released from snow disposal sites, both public and private. In both Canada and the United States, much new research has been directed at street deicing and snow disposal practices and their effects on the environment. Locally the Municipality of Anchorage has also focused its attention on these issues and has made progress in understanding and improving winter street maintenance and snow disposal practices. Private (on-site snow storage only) and commercial (off-site snow storage) snow disposal operations can benefit from these hard-won lessons. “Best management practices” taken as a whole are not only an optimal way to prevent environmental impacts but are also often the most beneficial approach from a business cost perspective as well. The following discussion summarizes best management practices for private (on-site snow storage only) snow disposal.

Municipal operators have discovered that the most cost-effective “best practices” include approaches that are applied at both the source of the plowed snow and at the disposal site. Like their municipal counterparts, operators responsible for plowing and on-site storage of snow from private parking lots and driveways are frequently responsible for application of winter surface treatments as well. Careful maintenance practices, including timing and types of salt and sand applications, will greatly reduce the ultimate pollutant load hauled to the snow disposal site—and reduce operation costs as well. After all, if you are plowing up salt and sand (that you have applied at great expense), it’s no longer helping improve traction across your client’s driveway or parking lot. Similarly, control of discharges of sediment and pollutants from a private snow storage site to the Municipal storm drain system is the responsibility of the site owner and operator. Up-front and practicable control of these pollutants, then, saves money and avoids fines and costly cleanup.

Though little specific information is available for privately operated on-site snow disposal operations, the pollutant sources and physical processes are similar to those that have become well documented for

Municipal and commercial sites. Operational guidance for private sites can be generally based on the current understanding of the pollutants and processes observed at these larger sites. Private operators will have to adjust actual practices to reflect the specific characteristics of different operational needs, snow sources and disposal sites, but the following practices are generally applicable.

- **Use Best Deicing Materials**

Buying the cheapest product is not always the least expensive practice, as each of us knows from experience in everyday life. The same is true in winter maintenance of parking lots and driveways. More is not always better and the cheapest is not always the least expensive: applying “smart” is the key. Consider the following uses:

Use magnesium chloride for small parking lots and sidewalks

Though it costs more, a molecule of magnesium chloride ($MgCl_2$) has two chloride ions and provides twice as much chloride as a molecule of sodium chloride ($NaCl$). Magnesium chloride is also effective at lower temperatures than sodium chloride. It is far less damaging to lawns and ornamentals (because magnesium replaces the sodium) and is less corrosive than sodium chloride, reducing capital and maintenance costs of landscaping, pavement and equipment. Conversely, the sodium ion (Na) in sodium chloride can not only kill landscape vegetation outright, but can also permanently ruin the soil.

Use coarser aggregate for “sanding”

Use of a coarser aggregate to improve winter traction on parking lots and sidewalks will reduce loss of effectiveness due to burial with continued snowfall or displacement by traffic (thus reducing need for re-application) and requires smaller additions of “antifreeze” salt to keep it free-flowing during application. It is also easier to spread uniformly. All these factors can greatly reduce total sand volumes required to achieve a similar effect (the Municipality has reduced total sand use by almost half since changing to a coarser sand specification).

- **Use Best Winter Maintenance Practices**

When and how you apply deicers to remove or loosen ice from sidewalks and driveways makes a big difference in how well they work, how much you apply, and ultimately how much it costs you. Minimize those areas that you treat to keep snow-and ice-free, but for those areas that must be kept bare, consider these practices:

Lightly apply deicers just before or just as snow begins to fall

This will help prevent a bond forming between the ice and the surface, making it easier to later simply shovel or plow the ice from the surface.

Do not apply deicers during a snowfall

They may appear to work briefly immediately upon application, but with continued snowfall will rapidly dilute and refreeze to form an even icier surface, and will ultimately be removed during plowing.

Apply deicers to melt snow and ice at the end of the storm

Application will be most effective immediately after you have removed the last of the new fallen snow. This is because to work, salt deicers not only require some moisture (to dissolve the salt) but also some heat. The heat, which is what actually melts the snow (calcium chloride is an exception because it releases heat as it dissolves in an exothermic reaction), may come from warming ambient temperatures, the sun's heat, or traffic. Applying deicers at the end of a snow storm takes advantage of these processes. You will use less deicer and have greater effect because temperatures will still be warm from the retreating storm front and the deicer will maintain greater antifreeze potency as the snow and ice melts.

Sweep or shovel surfaces free of slush and melted snow as soon as possible

A given concentration of salt is effective down to a certain temperature—as temperatures fall following a storm, melted ice will refreeze, necessitating continuing ice removal expenses.

- **Locate On-Site Snow Disposal Sites Effectively**

Avoid storing snow at locations within areas served by potable ground water wells

Salt in snow melt water is highly mobile, and mobilization of other pollutants can be promoted by high salt content. The cost for mitigating effects on ground water wells from inappropriately located or operated snow disposal sites will greatly outweigh any savings in snow hauling costs.

Avoid storing snow adjacent to residential and commercial properties

Operations at snow disposal sites typically include “high-stacking” snow. Snow also includes some sediment, trash and debris that become more noticeable as seasonal melting progresses. Because both these conditions can be visual nuisances to the site's residential and commercial neighbors, visual separation from these land uses is preferred. Where sites are located adjacent to these land uses, incorporate trees and dense vegetation along the site perimeter to act as visual and noise buffers and maintain as low a snow storage profile as possible. A low stored snow profile not only minimizes visual impacts but also will reduce impacts (and treatment costs) from salt released in the melt water.

Avoid draining snow storage sites to small lakes or streams

Salt in melt water is very “conservative”—it does not react or adsorb to other materials and so is very mobile. The best means of treatment are through minimization of initial concentrations (control initial salt application), minimization of leaching during melting (minimize the depth of stored snow), and by dilution. Because salt in melt water from snow

disposal site is at times concentrated, small waterbodies may not provide sufficient dilution, resulting in impacts to the receiving waters.

- **Operate Snow Disposal Sites Effectively**

- ***Minimize leaching of chloride and maximize melt water detention and infiltration***

The first melt water occurring at a snow disposal site can have very high salt concentrations. As each drop of melt water seeps vertically through a snow pile, salt is leached from the entire column of snow through which the drop of water flows. Early in the melt process, when the snow mass has all its original salt content, this leaching can increase salt in the melt water to concentrations much greater than that of the original pile. Conversely, as melting progresses, and when much of the salt has already been leached, salt concentrations in the melt water can become much smaller than that of the original plowed snow. A lower stored snow profile (a thinner pile) reduces the amount of snow that a drop of melt water passes through and thus reduces leaching and the peak salt concentration. As a general practice, place the snow in piles having larger footprints and lower profiles (do not exceed pile depths of 20 feet) to minimize the effects of salt leaching.

Preventing the first melt water from flowing off-site right away (“detaining” it) provides an opportunity for early, salt-rich melt water to be diluted by later melt water that has progressively lower salt concentrations. Infiltration likewise helps prevent rapid mobilization of initial salt-rich melt water, and, in addition, traps sediment on-site. Promote these effects by using as snow storage sites those areas having non-paved surfaces where possible (but only where potable ground water resources will not be put at risk), and grade the surface to encourage shallow impoundment of melt water on-site. Where snow storage/disposal must take place on pavement, place the snow on the lowest point on the pavement surface, and, as possible, direct melt water so that it will be detained on adjacent or nearby (on-site) permeable surfaces before discharge.

- ***Minimize mobilization of on-site sediments***

Fine sediments are common contaminants in plowed snow and can be easily mobilized during melting. However, seasonal on-site snow melt in Anchorage is by nature a slow and hydraulically low-energy process and there are many opportunities for practicable on-site treatment for this pollutant. The following are the basic elements of a best management practices plan for this pollutant. Place the first plowed snow of the year at the lowest point on the site, filling upslope from the initial fill point throughout the rest of the winter season. Stack hauled snow in a compact mass to a uniform thickness, maintaining steep sides and a relatively broad base (do not pile snow to depths greater than 20 feet). Maintain a vegetated site surface where possible. Armor and protect all drainage channels crossing the site and treat melt water, particularly for turbidity and salt, prior to its exit off-site. Placement of hauled snow at the low point should encourage ponding around the melting snow mass and minimize the length of flow paths for melt water draining across the site. Because much of the sediment in melt water is generated by the collapsing snow mass, stacking the snow with

very steep sides minimizes the amount of snow surface area that is most subject to this type of erosion. Piling the snow in a compact mass to uniform depths across a broad base (low stored snow heights) can significantly help reduce leached chloride concentrations in the early melt water released from the stored snow. Vegetated site surfaces help trap fine sediments, metals, and petroleum pollutants. For this reason it is important to promote spring revegetation by limiting site access and otherwise preventing trafficking and disturbance of the wet ground surface.

Where snow disposal must take place on pavement, placing snow across as broad a footprint as possible, at uniform depths and at the low point on the site remains important. In these cases it even more important to minimize the drainage path from the melting snow mass to the nearest storm drain inlet or ground surface discharge point. Where melt water flow exits a paved surface onto ground, dissipate flow energy by directing flow across a rock or grass apron. In all cases, providing unobstructed, armored melt water channels is important to minimize erosion. Flag dedicated site drainage channels so that hauled snow is not accidentally placed in them, creating the potential for diverting flow to more erodible surfaces. Armor the main channels: depending on site grade and the volume of melt water, grass or very small aggregate may provide adequate armor. Where melt water is not adequately treated through detention, site layout and operational practices, further treatment in on-site sedimentation basins or oil and grit separators may be required.

Clean snow disposal sites at the end of the snow melt season

Plowing snow inevitably incorporates some trash and debris. During active snow melt this debris remains wet and relatively immobile. At the end of the melt season, remove trash and litter from the site, and perform maintenance on drainage channels and sediment traps. If it is necessary to regrade the site, complete re-grading early and limit summer access to promote revegetation. Sweep all paved surfaces as soon as they become free of snow and impounded water (do not sweep sediments into the impounded water) and clean any melt water pollutant treatment devices (e.g., oil/grit separators, sedimentation basins, etc.).

Intentionally Left Blank

Appendix J:

Snow Disposal Site Seeding Specifications

Intentionally Left Blank

Snow Disposal Site Seeding Specifications

Section 1.0 SEEDING SNOW DISPOSAL SITES

Article 1.1 General

The work under this section shall consist of providing all labor, equipment, and materials for the preparation of ground surfaces for the application and maintenance of native grass seeded areas, fertilization, lime application (if necessary), watering and mulching at locations shown on the drawings or established by the Engineer.

All seeding shall be performed between May 1 and September 1. Seeding at other than the specified dates will only be allowed upon written approval from the Engineer. Seeding shall not be done during windy conditions or when climatic or ground conditions would hinder placement or proper germination of seed mixes.

Article 1.2

a. Seed

Seed shall conform to the following seed mix type and application rate.

Schedule A

Application rate: 4.5 lbs. /1,000 square feet

Name	Proportion by weight	Purity	Germination
<i>Festuca rubra</i>	40%	90%	85%
<i>Deschampsia caespitosa</i>	20%	90%	85%
<i>Leymus arenarius</i>	20%	90%	85%
<i>Beckmannia syzigachne</i>	20%	90%	85%

b. Fertilizer

Fertilizer shall be of a standard commercial type supplied separately or in mixtures and furnished in moisture-proof containers. Each container shall be marked with the weight and the manufacturer's guaranteed analysis of the contents showing the percentage for each ingredient contained therein. The proportion of chemical ingredients furnished shall be a mixture such as to provide the total available nitrogen, phosphoric, and potassium as required by the soil analysis or as specified in the Special Provisions.

c. Limestone

Limestone shall contain not less than 85 percent of calcium and magnesium carbonates. Agricultural ground limestone suitable for application by a fertilizer spreader shall conform to the following gradation:

<u>Sieve Designation</u>	<u>Minimum Percent Passing by weight</u>
No. 10	100
No. 20	90
No.100	50

Fertilizer and limestone for use in a hydraulic sprayer shall be soluble or round to a fineness that will permit complete suspension of insoluble particles in water.

Article 2.3 Application

a. Soil preparation

After grading of areas has been completed in conformity with the lines and grades shown on the Drawings, and before beginning seeding operations, the area to be seeded shall be cultivated to provide a reasonably firm but friable seedbed. Cultivation shall be carried to a depth of two inches. On slopes steeper than three horizontal to one vertical (3:1), depth of cultivation may be reduced as directed by the Engineer. All cultivated areas shall be raked or cleared of stones one inch in diameter and larger; all weeds, plant growth, sticks, stumps and other debris or irregularities which might interfere with the seeding operation, germination of seed, or subsequent maintenance of the seed cover areas shall be removed.

b. Fertilizer

Fertilizer shall be applied at a rate to provide 2 lbs. actual nitrogen per 1,000 square foot of area. In the absence of soil tests and the direction from the Engineer, the Contractor shall apply 16-16-16 at the rate of 12.5 lbs per 1,000 sf.

Article 2.4 Maintenance

The contractor shall protect seeded areas from damage from all traffic, whether people, animals, on or off-road vehicles, or any other causes that may damage newly seeded and maintained surfaces. Surfaces damaged shall be repaired by regrading, reseeding (including all specified amendments) as directed by the Engineer and at no additional cost to the Owner. The contractor shall otherwise maintain seed areas in a satisfactory condition until Final Acceptance of the work.

Appendix K: Daily Pollutant Buildup Ranges

Intentionally Left Blank

Daily Pollutant Build-Up Ranges

Land Use	BOD5 ¹ (lbs/Ac/Day)	SUS-SOL ² (lbs/Ac/Day)	SET-SOL ³ (lbs/Ac/Day)	TDS ⁴ (lbs/Ac/Day)	NH3 ⁵ (lbs/Ac/Day)	NO3 ⁶ (lbs/Ac/Day)	TOT-P ⁷ (lbs/Ac/Day)	GRS-OIL ⁸ (lbs/Ac/Day)	FE-COL ⁹ (BILLION MPN/Ac/Day)
Commercial	0.33-0.43	4.9-5.0	0.004-0.005	0.8-1.3	0.005-0.010	0.002-0.006	0.007-0.25	0.20-0.23	0.009-0.15
Industrial	0.35-0.60	7.5-7.5	0.0075-0.01	1.0-2.0	0.005-0.010	0.0005- 0.003	0.0053-0.10	0.30-0.34	0.002-0.01
Multiple-Family Residential	0.12-0.34	0.50-1.6	0.001-0.005	0.40-1.3	0.005-0.015	0.0012- 0.0015	0.0035-0.08	0.06-0.10	0.0008-0.007
High-Density Residential	0.10-0.49	0.20-1.0	0.003-0.004	0.3-0.8	0.002-0.016	0.001-0.002	0.002-0.15	0.03-0.04	0.002-0.002
Low-Density Residential	0.05-0.10	0.15-0.7	0.001-0.002	0.25-0.3	0.002-0.005	0.0005- 0.001	0.0014-0.02	0.01-0.02	0.001-0.0015
Cleared and Pervious	0.02-0.05	0.10-0.5	0.001-0.001	0.2-0.3	0.002- 0.0005	0.0001- 0.0005	0.0007-0.01	0.001-0.002	0.001-0.001
Bogs and Marshes	0.01-0.02	0.0-0.0	0.0-0.0	0.1-0.2	0.0001- 0.0002	0.0001- 0.0001	0.0007- 0.0007	0.0-0.0001	0.0001-0.001
Lowland Forest	0.01-0.01	0.0-0.0	0.0-0.0	0.1-0.1	0.0001- 0.0002	0.0001- 0.0001	0.0007- 0.0007	0.0-0.0001	0.0001-0.001
Upland Forest	0.01-0.01	0.0-0.0	0.0-0.0	0.1-0.1	0.0001- 0.0002	0.0001- 0.0001	0.0007- 0.0007	0.0-0.0001	0.0001-0.001
Natural Pervious	0.01-0.01	0.0-0.0	0.0-0.0	0.01-0.1	0.0001- 0.0002	0.0001- 0.0001	0.0007- 0.0007	0.0-0.0001	0.0001-0.001

(1) BOD5 – Biological Oxygen Demand (5) NH3 – Ammonia Nitrogen (9) FE-COL – Fecal Coliform

(2) SUS-SOL – Suspended Solids (6) NO3 – Nitrate Nitrogen

(3) SET-SOL – Settleable Solids (7) TOT-P – Total Phosphorus

(4) TDS – Total Dissolved Solids (8) GRS-OIL – Grease and Oil

Intentionally Left Blank

Appendix L:

Green Infrastructure Feasibility Forms

Intentionally Left Blank



**Roadway Project
Determination of Low Impact Development/Green Infrastructure
vs. Traditional Stormwater Treatment**

1. Project Name _____

2. Project Location _____

3. Project Owner _____

4. Project Contact Name _____ Phone _____ Email _____

5. Project Description/Purpose _____

6. Project Type

New Construction

Rehabilitation, re-construction, upgrade etc.

*Note that roadway resurfacing and certain types of maintenance projects are exempt from stormwater treatment requirements per Chapter 3 of the ASM Volume 1. Refer to Chapter 3 for additional information.

7. Describe the following site parameters. Attach soils logs, field testing results, and laboratory testing results, as applicable.

a. General Native Soil Condition

Gravels Sandy silt

Sandy gravels Silt

Gravely sands Clay/Silt

Sands Other (please describe) _____

Silty sand

b. Saturated Soil Percolation Rate (if field percolation testing was performed)

<0.5 inches/hour

0.5 to 1 inches/hour

1 to 3 inches/hour

4 to 8 inches/hour

>8 inches/hour

Testing has not been performed

c. Depth of groundwater table is _____ feet below finished ground surface on _____ (date).

d. Project ROW width after any ROW acquisition is completed _____

e. Total width of roadway improvements _____ Total thickness of structural section _____

f. Attach a sketch of the project’s proposed typical section within the ROW. Include dimensions.



Roadway Project
Determination of Low Impact Development/Green Infrastructure
vs. Traditional Stormwater Treatment

8. Check all types of facilities that were considered, including facilities that may be a combination of one or more of these.

<input type="checkbox"/> Bioretention	<input type="checkbox"/> Pervious Pavement
<input type="checkbox"/> Chamber Systems	<input type="checkbox"/> Canopy Cover/Vegetation Retention
<input type="checkbox"/> Infiltration Basin	<input type="checkbox"/> Infiltration Basin
<input type="checkbox"/> Filter Strips	<input type="checkbox"/> Use of Landscaping for Stormwater Management
<input type="checkbox"/> Vegetated Swales	<input type="checkbox"/> Other (please list) _____
<input type="checkbox"/> Soak-away Pits	

9. Check all modifications that were considered.

- Addition of a sub-drain
- Addition of a bypass or overflow
- Application of the 20% area allowance? (See description in ASM Vol 1 Chapter 3, Section 3.2.2.1)
- Soil amendments
- Application of a different technique (e.g. filtration if infiltration is not feasible)
- Other (please list) _____

10. Provide a sketch that depicts the general site drainage. (Locations of drainage features, receiving systems, flow directions, etc.)

11. Provide a detailed explanation for why Green Infrastructure is not feasible for this project. Address the relevance of modifications. Use additional sheets and attach supporting information if needed.



**Roadway Project
Determination of Low Impact Development/Green Infrastructure
vs. Traditional Stormwater Treatment**

11. Continued

Signature

Signature of Project Engineer required. Project Engineer must be a registered Professional Civil or Environmental Engineer in the State of Alaska.

Printed Name _____ Professional License Number _____

Name of Firm _____ Phone _____ Email _____

For Municipal Use Only

Based on the above information, Low Impact Development/Green Infrastructure

- is likely feasible and should be incorporated into this project.
- Is likely not feasible and traditional treatment methods are allowable.
- Additional Information is needed.

Name _____ Date _____

Signature _____



Site Development
Low Impact Development/Green Infrastructure vs. Traditional Treatment Determination
or
Request for Alternative Compliance

<p>1. Project Name _____</p> <p>2. Project Location _____</p> <p>3. Project Owner: _____</p> <p>4. Project Contact Name _____ Phone _____ Email _____</p> <p>5. Project Description/Purpose _____</p> <p>_____</p>
<p>6. Request Type</p> <p><input type="checkbox"/> Approval of Traditional Stormwater Treatment</p> <p><input type="checkbox"/> Alternative Compliance Request</p>
<p>7. This project is</p> <p><input type="checkbox"/> New Development <input type="checkbox"/> Re-development</p>
<p>8. Describe the following site parameters. Attach soils logs, field testing results, and laboratory testing results, as applicable.</p> <p>a. General Native Soil Condition</p> <p><input type="checkbox"/> Gravels <input type="checkbox"/> Sandy silt</p> <p><input type="checkbox"/> Sandy gravels <input type="checkbox"/> Silt</p> <p><input type="checkbox"/> Gravelly sands <input type="checkbox"/> Clay/Silt</p> <p><input type="checkbox"/> Sands <input type="checkbox"/> Other (please describe) _____</p> <p><input type="checkbox"/> Silty sand</p> <p>b. Saturated Soil Percolation Rate (if field percolation testing was performed)</p> <p><input type="checkbox"/> <0.5 inches/hour</p> <p><input type="checkbox"/> 0.5 to 1 inches/hour</p> <p><input type="checkbox"/> 1 to 3 inches/hour</p> <p><input type="checkbox"/> 4 to 8 inches/hour</p> <p><input type="checkbox"/> >8 inches/hour</p> <p><input type="checkbox"/> Testing has not been performed</p> <p>c. Depth of groundwater table is _____ feet below finished ground surface on _____ (date).</p> <p>d. Site Area (Acres/SF) _____ Land Use Zoning Designation _____</p> <p>e. Area and description of impervious surfaces _____</p> <p>f. Average site slope: Existing _____ Proposed _____</p>



Site Development
Low Impact Development/Green Infrastructure vs. Traditional Treatment Determination
or
Request for Alternative Compliance

9. Check all types of facilities that were considered, including facilities that may be a combination of one or more of these.

<input type="checkbox"/> Bioretention	<input type="checkbox"/> Pervious Pavement
<input type="checkbox"/> Chamber Systems	<input type="checkbox"/> Canopy Cover/Vegetation Retention
<input type="checkbox"/> Infiltration Basin	<input type="checkbox"/> Infiltration Basin
<input type="checkbox"/> Filter Strips	<input type="checkbox"/> Use of Landscaping for Stormwater Management
<input type="checkbox"/> Vegetated Swales	<input type="checkbox"/> Other (please list)_____
<input type="checkbox"/> Soak-away Pits	

10. Check all modifications that were considered.

- Addition of a sub-drain
- Addition of a bypass or overflow
- Application of the 20% area allowance? (See description in ASM Vol 1 Chapter 3, Section 3.2.2.1)
- Soil amendments
- Application of a different technique (e.g. filtration if infiltration is not feasible)
- Other (please list) _____

11. Provide a sketch that depicts the general site drainage. (Locations of drainage features, receiving systems, flow directions, etc.

12. Are there conflicting MOA regulations that are preventing/inhibiting the use of Green Infrastructure? (For example, if adequate space is not available due to parking space requirements).

No Yes: Code or Regulation Reference_____

13. Provide an explanation for why LID/Green Infrastructure is not feasible for this project or describe the alternative compliance that is requested. When considering LID/GI feasibility, address the relevance of modifications. Use additional sheets and attach supporting information if needed.



Site Development
Low Impact Development/Green Infrastructure vs. Traditional Treatment Determination
or
Request for Alternative Compliance

13. Continued.
<p>Signature _____</p> <p>Signature of Project Engineer required. Project Engineer must be a registered Professional Civil or Environmental Engineer in the State of Alaska.</p> <p>Printed Name _____ Professional License Number _____</p> <p>Name of Firm _____ Phone _____ Email _____</p>
<p><i>For Municipal Use Only</i></p> <p>Based on the above information, the request for</p> <p><input type="checkbox"/> The use of Traditional Stormwater Treatment</p> <p><input type="checkbox"/> Alternative Compliance Request</p> <p>Is hereby</p> <p><input type="checkbox"/> Approved <input type="checkbox"/> Dis-approved <input type="checkbox"/> Additional Information Needed</p> <p>Name _____ Date _____</p> <p>Signature _____</p>