



---

## **MEMORANDUM**

### **Private Street General Guidelines**

The Municipality of Anchorage Traffic Department has established the following guidelines for the production and installation of a 'private' street sign (D3-1P). The lower portion of the sign should follow the standard 8" D3-1D guidelines as set forth in the Alaska Department of Transportation and Public Facilities Alaska Sign Design Specifications – see attached. All streets and roadways designated as 'private' must adhere to the following guidelines.

## **D3-1P 'PRIVATE' STREET SIGN**

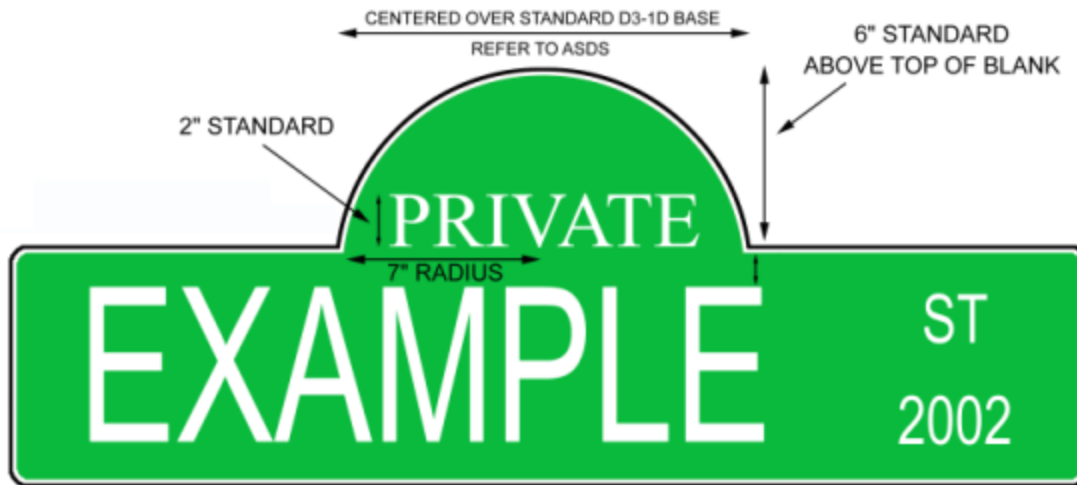

NOTE: All signs should be installed on Telspar posts in accordance with the attached mounting and installation details.

# D3-1D

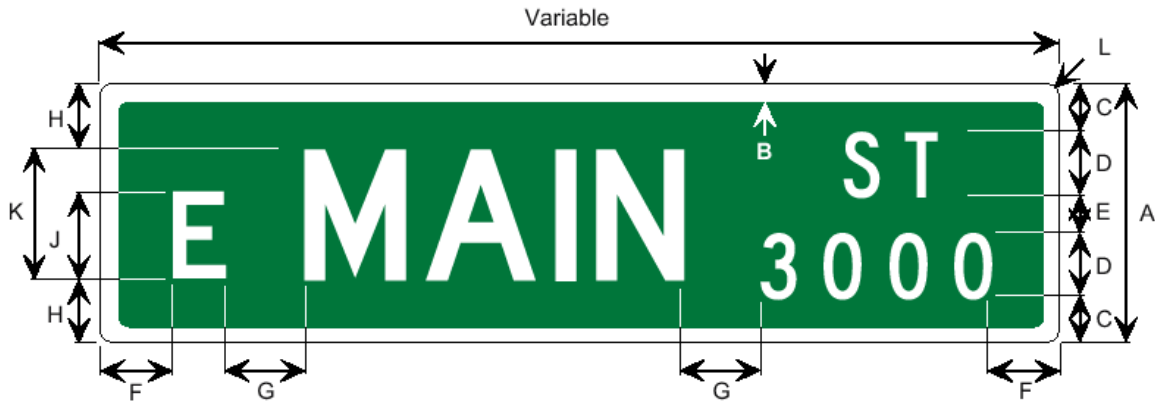

Border and Legend: White  
Background: Green

Print legend on both  
sides of sign.

\* Letters may be series B, C, or D.

Road Class	Dimensions (inches)										
	A	B	C	D	E	F	G	H	J	K	L
Local Rds w Spd Limits <= 25MPH	8	0.5	1.5	2*	1	2	3	2	3*	4*	1.5
All Other Roads	12	0.5	2.0	3*	2	3	4	3	4*	6*	1.5

# Installation Details



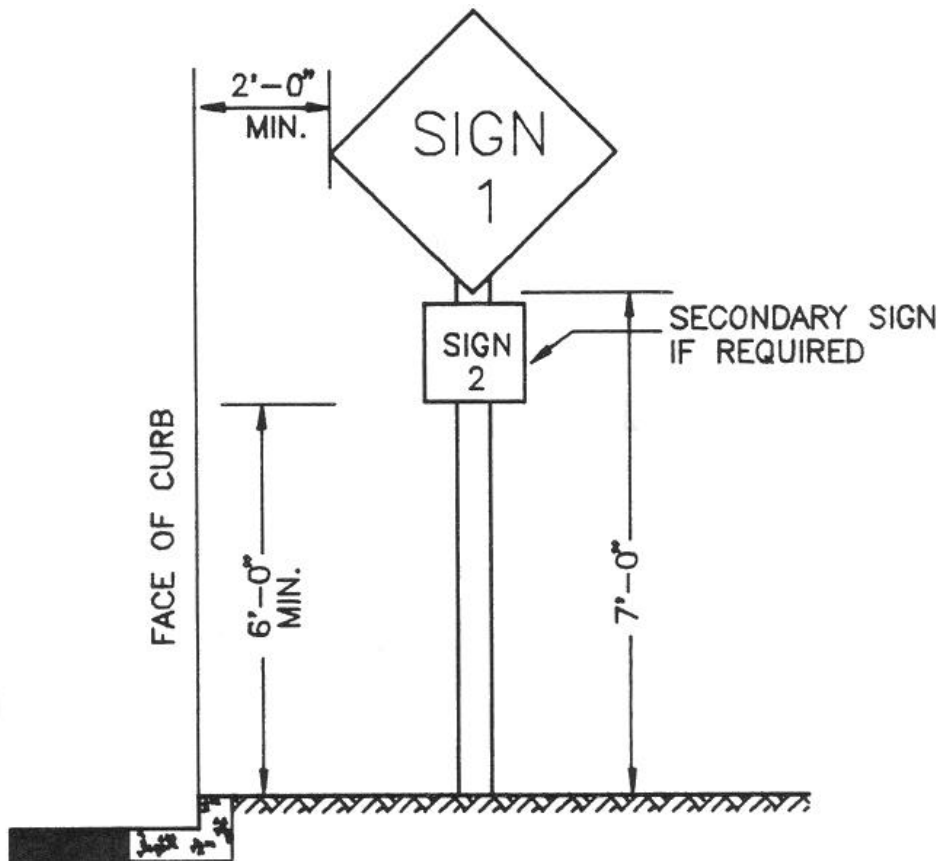

**Sign Placement Curb Without Sidewalk**

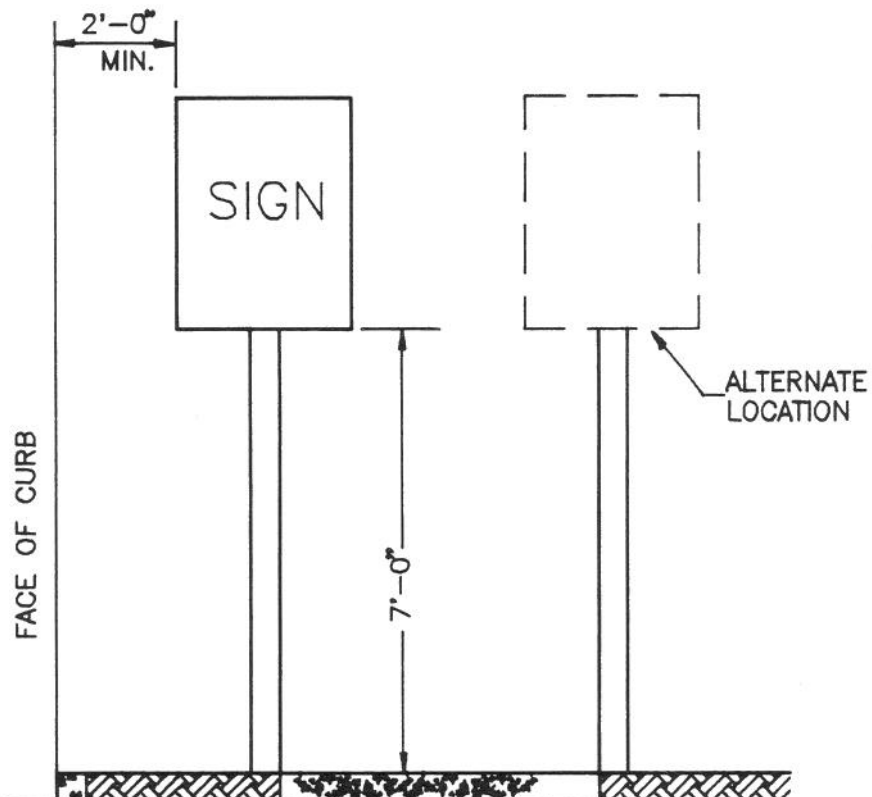

**Sign Placement Curb With Sidewalk and Parkway**

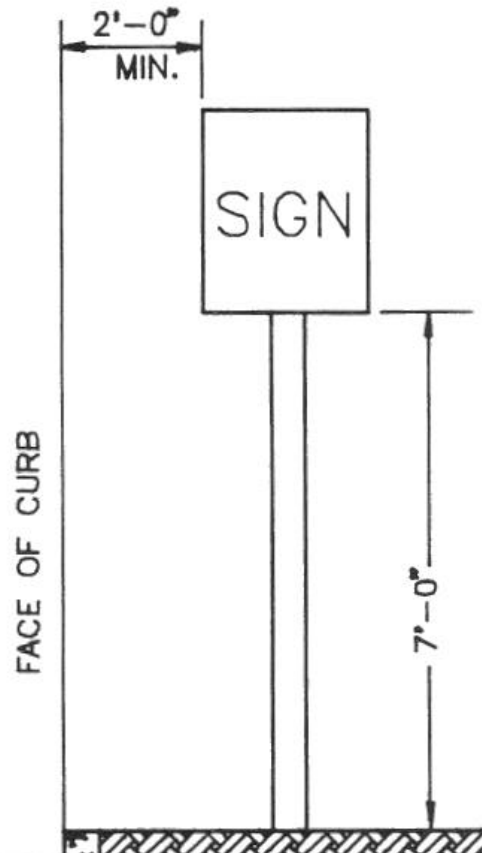

**Sign Placement Curb With Sidewalk**

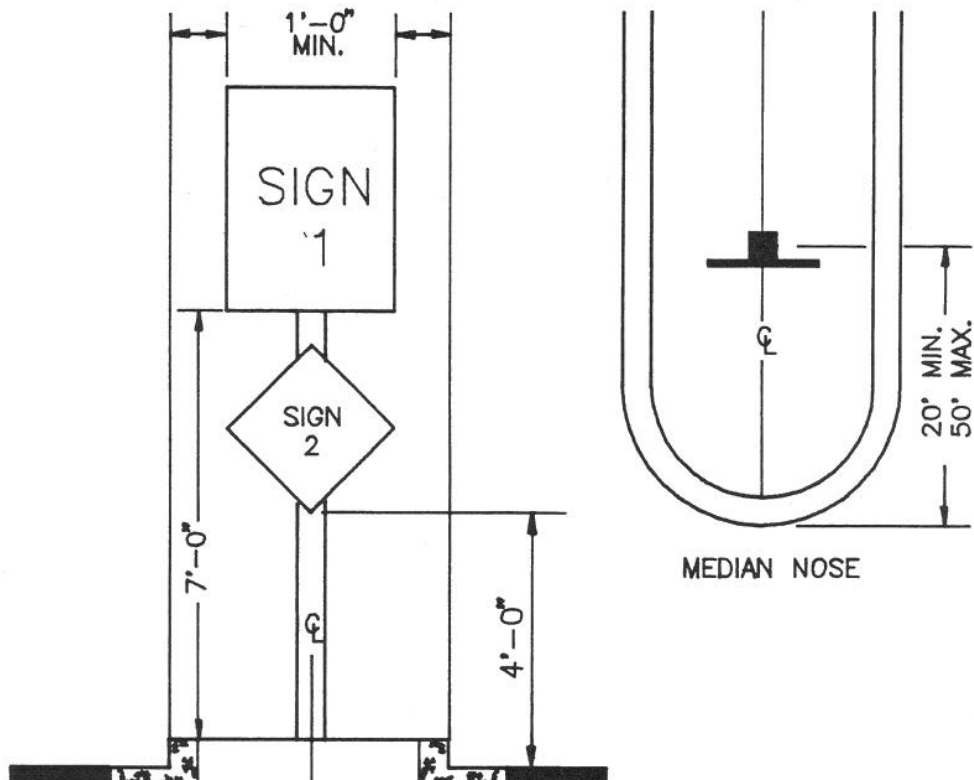

**Sign Placement Medians**

### Street Name Signs

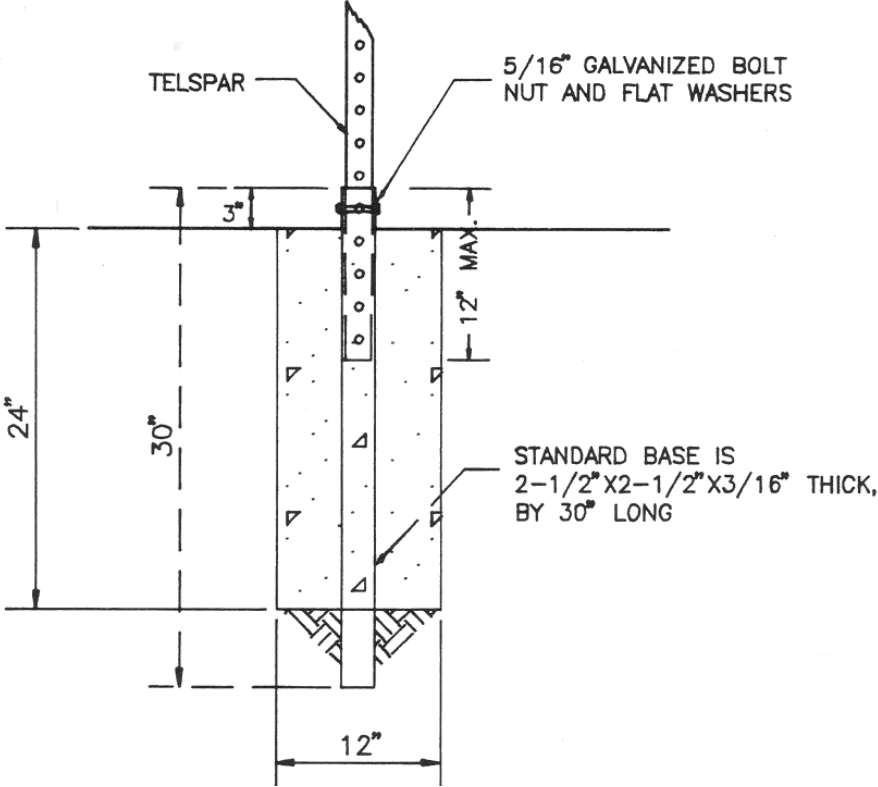

### Concrete Foundation for Sign Post